

Carl Kammerling

International

Brand Innovation

PR Support
Benelyckevägen 11
44370 Gråbo
0768 444095
peer.rott@pr-support.se
www.pr-support.se



PRODUCT CATALOGUE

JANUARY 2024



avit

»» JOKARI[®]
original



CLIPACORÉ



www.carlkammerling.com



C.K Tools

Pliers & Cutters	8-27
Screwdrivers	28-47
Cable Routing	48-55
Electricians' Specialist Tools	56-65
Toolkits	66-71
ESD & Precision	72-103
Power Tool Accessories	104-129
Building & Decorating	130-139
Striking Tools	140-145
Sawing, Cutting & Filing	146-155
Automotive & Engineering	156-167
Marking & Measuring	168-175
Water Systems	176-181
Lighting	182-187



C.K Magma	188-199
Avit	200-211
Jokari	212-227
C.K Classic	228-241
Clipacore	242-247
Kasp	248-283
Index	284-305

Carl Kammerling

International

Brand Innovation

Carl Kammerling International have been in the business of tool making and distribution since 1790, when P.L.S (Peter Ludwig Schmidt) was established. We've been at the forefront of technological and industrial changes and challenges ever since, determined to innovate and improve our products based on the needs of the market.

Simple, streamlined, and economic by nature, we strive to develop items that aren't only reasonably priced, but represent genuine value, for our customers and end-users.

Since the foundation of CK in 1904, the company has established an unrivalled reputation for quality and innovation. As the brand and business have grown, new additions to the Carl Kammerling International family have contributed to these core values, placing professional needs at the heart of growth.

We are, at heart, a family business, now being led by the fourth generation, and as such, we value quality, longevity, and expertise. A classic example of the German mittelstand business model, our core values reflect a culture of respect, of looking to the future, and of steady, sustainable growth. While remaining large enough to adapt to a rapidly changing marketplace, we've stayed small enough that our customers still have designated points of contact and real people to reach out to.

From our UK headquarters in Pwllheli, international office in Wuppertal, Germany (the heartland of German toolmaking), our sales teams in the UK, Eire, France and Germany, and a network of distributor partners, we have established a position among the top hand tool brands in more than 40 countries.





Smarter by design

C.K Magma combines optimal functionality with creative flair to deliver an eye-catching range of premium storage and accessories that are truly smarter by design. C.K Magma products are designed to get the job done, without compromising on practicality and quality.

Developed in collaboration with trade professionals with easy access and convenience in mind; with C.K Magma, every tool has a place, and there's a place for every tool.



Traditionally crafted tools

C.K Classic products reflect the heritage and quality associated with all Carl Kammerling International brands. A range of dependable garden tools and durable hardware products that combine traditional manufacturing methods with the latest technology and C.K's reputation for innovation. Our Legend range combines hot-dropped forged blades with hardwood handles, while our Maxima caters towards those needing lightweight, wear-resistant pieces, with extra grip and support.

All C.K Classic products are meticulously crafted using traditional practices to ensure lasting performance and appeal to both the dedicated professional and DIY enthusiast; the first-time gardener to the seasoned horticulturalist.



Designed for professionals

For over 100 years, C.K has been at the forefront of hand tool manufacturing, producing high quality tools that meet the most demanding needs of trade professionals. C.K Tools is our signature line of products, engineered to offer leading performance, durability, accuracy, and strength, all of which are key requirements for professional results.

Not content with simply conforming to all relevant international standards, C.K Tools work with metallurgical and design engineers to develop new materials, manufacturing techniques and finishing treatments to push the boundaries of performance.

Driven by research through an extensive panel of cross trade professionals, our tools are developed to assist with everyday tasks; an approach proven to produce innovative tools that transform working practices. Product development is generated by our UK-based team, and our core products are still made and sourced through Germany.

Our Brands

The CKI group includes a range of brands that complement our ethos of innovation, quality, and value. Each has a distinct personality and purpose, whilst remaining true to our goals and identity.



avit

For a proper job

Avit offers a range of well made, well presented and well-priced products that appeal to both the DIYer and trade professional alike. Perfect for essential purchases and those building their kit, Avit offers a price-point friendly option for jobs ranging from automotive to demolition!

Striking packaging and displays have a bright modern look and create real impact instore, encouraging trade up; increasing sales and profit.



»» JOKARI®

original

Uncompromisingly good

Carl Kammerling International is the exclusive UK distributor of Jokari, a leading German brand with 45 years' experience. Specialists in stripping and dismantling all types of wires, cables, and conductors, Jokari produce professional tools for all scenarios. Promising speed, ease, and safety, Jokari provide solutions for the demands of all professionals in the trade, the perfect partner to the C.K Tools range.



CLIPACORE®

The clip release revolution

The Clipacore release system provides consistent results quickly! Compared to current core drill release techniques, our easy-to-use patented design removes the need for spanners and excessive force. We have taken away the frustration from components tightly locking up due to torque tension, leading to expensive damage to core pieces and power tools. Clipacore products are designed and manufactured in the UK, using high-tensile alloy steel.

Adaptable for use with the majority of the market's favourite drills, or as a complete unit. For workflow efficiency, the Clipacore range of products make an essential addition to the professional tradesperson's toolbox.



kasp

SECURITY

Locks you can trust

Kasp locks are designed and manufactured to the highest standards. Precision engineered from premium grade materials, ensuring exceptional strength and outstanding reliability. Kasp locks are renowned for being locks you can trust, from combination padlocks to high-security, hardened-steel options.

To maximise sales potential, the Kasp range is supported by strong POS and merchandising solutions that stand out. The colour-coded packaging is designed to be informative to assist in selecting the correct products for any security requirement.



Quality control

The CKI Quality Policy is available on our website and guarantees the standards we insist upon for all our products, establishing a culture of communication (from our users and employees alike). Consistent monitoring and reviewing of our products and processes ensures that this culture persists, and that not only do we meet all relevant operational standards (we have been ISO9001 compliant since 1991), we surpass them.

Product innovation

New and innovative products are a cornerstone of CKI's identity. We pride ourselves on developing products and ranges inspired, and requested, by our customers and end-users. When our customers face an issue, they can rely on us to identify and solve it. We are driven by a product ethos of innovation, quality and durability, and our product development is the lifeblood of the brand.

Backed by extensive research and a deep understanding of the profession, hard-won over the course of a century, our tools are conceived in collaboration with trade professionals, and are developed by embracing new technologies.

Free online training

Productwise is a unique, free of charge service provided by CKI. Our video tutorials provide industry-standard training for best-practice in using our tools and equipment. Users can select modules and earn certificates, demonstrating their progress and expertise.

For those studying, Productwise is a great insight into product-specific training; from our end-users already in the trade, to counter staff in stores, it offers a valuable opportunity for development, ensuring that the newest technology is as accessible as possible for users at all levels.

To enroll in Productwise, visit

www.productwise.co.uk

Bright Sparks

At the heart of CKI is our vision for the future, and we see no better investment in that future than by investing in the apprentices who will go on to use our tools for the rest of their careers. Every year, we provide 60 colleges across the UK with free-of-charge tools, and demonstrations on how best to use them. The Bright Sparks scheme, founded in 2003, was the first programme of its kind, and has supported over 50,000 students through their education and into their chosen vocation.

PR, social media, and advertising

Your customers know us because we've invested in communicating directly with them. End users recognise us from our consistent online presence across social media platforms, where we have worked hard to build genuine communities for our customers and users.

Alongside our online presence, we invest in traditional media targeted at professionals. Appearing in trade-specific publications allows us to target end-users and assist them in contacting their most convenient retailer: our customers.

Finally, our presence at some of the industry's most popular trade shows means that end users get to know our products, and team, in person. We offer in-person product trials and demonstrations, and members of our sales, marketing, and product development teams are on hand.

Every interaction and encounter we have drives brand loyalty, builds excitement around products, increases brand awareness, and reiterates CKI's consistent presence in an ever-changing market.

Carl Kammerling

International

Stockist support that sets us apart

Exceptional service

Same day dispatch and next day delivery for mainland UK, 3 – 4 day delivery for Ireland and France with the rest of Europe receiving a 5-6 day service. Our state-of-the-art warehouse and excellent team boast a 98% fill rate, and a 96% OTIF rate (On Time, In Full). Our priority is that our customers get the goods they want, when they want them.

Merchandising and packaging

Our clear, informative packaging and easy-to-shop merchandising gives us instant, impactful, and recognisable in-store presence. We have invested in eye-catching merchandising to give customers a variety of options to create displays that suit their needs. Our regular promotions offer value to our customers, and theirs, ensuring footfall and returning custom throughout the year.

Online ordering

Our online order system empowers 24/7, self-serve purchasing, where our customers can create and manage their orders in the time and place that best suits them. Ordering before 3pm ensures next-day delivery to the UK mainland, and our real-time stock pricing information, order history and promotional deals are all available in one, convenient space.

To sign-up for an online account, visit www.carlkammerling.com

Customer communication

Get product news and promotions by signing up to emails, following us across social media, or opting in to hear from us by post.

Simply visit www.carlkammerling.com and opt in to CKI Connect when registering for an account.





Pliers & Cutters

Redline VDE	11
Redline	13
Classic	16
Waterpump Pliers	17
Ratchet Crimping Pliers	18
Crimping Pliers	18
Heavy Duty Cutters	22
Pincers & Top Cutters	23
Conduit Cutters	24
Pipe Cutters	24
Circlip Pliers	25
Snips	26
Riveting Pliers	26
Punch Pliers	27
Fencing Pliers	27

RedLine™ VDE

Premium quality insulated pliers and cutters

1. Two component, ergonomic design, with anti-slip horns for increased comfort, control and safety.
2. Induction hardened jaws for outstanding long term performance.
3. Cutting jaws with C.K optimised geometry for unsurpassed cutting performance.
4. Special alloy steel, drop forged, hardened and tempered for exceptional strength and durability.
5. VDE approved - individually tested to 10,000V for safe live working up to 1,000V.

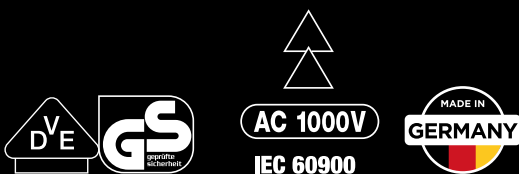

Conforms to IEC 60900. Approved and independently audited by the German VDE institute.



VDE Combicutter1

Pattress screw shear for damage free cutting of 3.5mm pattress screws.

BS EN60900, VDE0682/201, ASTM-F 1505, ISO 5749

Item No.	Length	Wire Size 1	Wire Size 2	Wire Size 3	Quantity
431004	160mm (6")	2.0mm	2.8mm	>4.0mm	3



VDE Combicutter1 Max

Pattress screw shear for damage free cutting of 3.5mm pattress screws & 4mm conduit cover screws.

EN 60900, VDE0682/201, ASTM-F 1505

Item No.	Length	Wire Size 1	Wire Size 2	Wire Size 3	Quantity
T39071-1180	180mm (7")	2.5mm	3.0mm	>4.0mm	3



VDE Combicutter2

Pattress screw shear for damage free cutting of 3.5mm pattress screws. Wire stripping notches for effortless & damage free stripping of 1.5 & 2.5mm² wire.

BS EN60900, VDE0682/201, ASTM-F 1505, ISO 5749

Item No.	Length	Wire Size 1	Wire Size 2	Wire Size 3	Quantity
431009	160mm (6")	2.0mm	2.8mm	>4.0mm	3



VDE Combicutter3

Pattress screw shear for damage free cutting of 3.5mm pattress screws. Wire stripping notches for effortless & damage free stripping of 1.5 & 2.5mm² wire. Wire bending anvil for quick & damage free doubling back of copper wire.

BS EN60900, VDE0682/201, ASTM-F 1505, ISO 5749

Item No.	Length	Wire Size 1	Wire Size 2	Wire Size 3	Quantity
431008	160mm (6")	2.0mm	2.8mm	>4.0mm	3



VDE Combicutter3 Max

Pattress screw shear for damage free cutting of 3.5mm pattress screws & 4mm conduit cover screws. Wire stripping notches for effortless & damage free stripping of 1.5 & 2.5mm² wire. Wire bending anvil for quick & damage free doubling back of copper wire.

EN 60900, VDE0682/201, ASTM-F 1506

Item No.	Length	Wire Size 1	Wire Size 2	Wire Size 3	Quantity
T39071-3180	180mm (7")	2.5mm	3.0mm	>4.0mm	3



VDE Wire Stripping Side Cutter

Wire stripping notches for effortless & damage free stripping of 1.5 & 2.5mm² wire.

BS EN60900, VDE0682/201, ASTM-F 1505, ISO 5749

Item No.	Length	Wire Size 1	Wire Size 2	Wire Size 3	Quantity
431019	160mm (6")	2.0mm	2.8mm	>4.0mm	3



RedLine VDE Cable Cutters

Independently VDE certified, safe up to 1000 V AC. Razor sharp, induction hardened cutting edges for outstanding performance. Special alloy steel construction.

Item Number	Length	Opening	Quantity
T3973 160	160mm	9mm	3
T3973 210	210mm	11mm	3



VDE Side Cutter

Induction hardened cutting jaws with optimised geometry for unsurpassed cutting performance.

BS EN60900, VDE0682/201, ASTM-F 1505, ISO 5749

Item No.					
431018	140mm (5 1/2")	1.4mm	1.9mm	>4.0mm	3
431017	160mm (6")	2.0mm	2.8mm	>4.0mm	3
431005	180mm (7")	2.5mm	3.0mm	>4.0mm	3



VDE Electricians Pliers

Specially designed for electrical installation work where space is restricted. Tapered nose - streamlined for better access, and ideal for gripping nuts and cutting wires in recessed cabinets. Gutter nut holder - specially profiled jaw for securely holding square nuts used on cable trays and cabinets. Pin holder - machined at 90° to the angled face for holding cable clips/ nails upright while hammering.

EN 60900, VDE0682/201, ASTM-F 1506

Item No.					
T39077-180	180mm (7")	1.6mm	2.5mm	>4.0mm	3



VDE High Leverage Side Cutter

33% slimmer than the previous model for greater accessibility in tight access areas. High leverage design for increased cutting capacity.

BS EN 60900, VDE0682/201, ASTM-F 1505

Item No.					
T37021 180	180mm	2.2mm	3.8mm	6mm	3
T37021 200	200mm	2.5mm	4.2mm	6mm	3



VDE Combination Pliers

Precision engineered jaws for exceptional grip. Extra long cutting edges for increased cutting capacity.

BS EN60900, VDE0682/201, ASTM-F 1505, ISO 5746

Item No.					
431001	165mm (6 1/2")	1.6mm	2.5mm	>4.0mm	3
431002	185mm (7")	1.6mm	2.5mm	>4.0mm	3
431003	200mm (8")	2.0mm	2.8mm	>4.0mm	3



VDE Cable Cutters

Shearing action for clean cut results. Razor sharp, parrot beak blades for effortless cuts. Suitable for copper & aluminium wire only.

BS EN 60900, VDE0682/201, ASTM-F 1505

Item No.			
431030	160mm (6")	15.0mm	3
431031	210mm (8 1/4")	20.0mm	3



VDE Snipe Nose Pliers - Straight

Serrated inside jaws for secure gripping.

BS EN60900, VDE0682/201, ASTM-F 1505, ISO 5745

Item No.					
431013	175mm (6 1/2")	1.4mm	2.0mm	>4.0mm	3
431014	200mm (8")	1.6mm	2.0mm	>4.0mm	3



VDE Snipe Nose Pliers - Bent

Serrated inside jaws for secure gripping. Bent nose for special access needs.

BS EN60900, VDE0682/201, ASTM-F 1505, ISO 5745

Item No.					
431015	200mm (8")	1.6mm	2.5mm	>4.0mm	3



VDE Wire Stripping Pliers

Micro adjustment for damage free, repeatable results. Spring assisted opening for convenience.

BS EN 60900, VDE0682/201, ASTM-F 1505

Item No.			
431012	160mm (6")	0.3 - 5.0mm	3



VDE Pliers Set - 3 Piece

CONTENTS: Combicutter 160mm, Combination Pliers 185mm, Snipe Nose Pliers 200mm.

BS EN60900, VDE0682/201

Item No.	
T3805	3

RedLine



Redline Side Cutter

Induction hardened cutting jaws with optimised geometry for unsurpassed cutting performance.

ISO 5749

Item No.					
T3750 145	140mm (5 1/2")	1.4mm	1.9mm	>4.0mm	3
T3750 160	160mm (6")	2.0mm	2.8mm	>4.0mm	3
T3750 180	180mm (7")	2.5mm	3.0mm	>4.0mm	3



Redline High Leverage Side Cutter

33% slimmer than the previous model for greater accessibility in tight access areas.

High leverage design for increased cutting capacity.

Item No.					
T3721 180	180mm (7")	2.2mm	3.8mm	>6.0mm	3
T3721 200	200mm (8")	2.5mm	4.2mm	>6.0mm	3



Redline Cable Cutters

Shearing action for clean cut results. Razor sharp, parrot beak blades for effortless cuts. Suitable for copper & aluminium wire only.

Item No.			
T3964 6	160mm (6")	16.0mm	3

RedLine™

Premium quality
pliers and cutters

1. Two component, ergonomic design, with anti-slip horns for increased comfort, control and safety.
2. Induction hardened jaws for outstanding long term performance.
3. Cutting jaws with C.K optimised geometry for unsurpassed cutting performance.
4. Special alloy steel, drop forged, hardened and tempered for exceptional strength and durability.



Conforms to DIN standards.



Redline Combination Pliers

Precision engineered jaws for exceptional grip. Extra long cutting edges for increased cutting capacity. ISO 5746

Item No.					
T3867 6	160mm (6")	1.6mm	2.5mm	>4.0mm	3
T3867 7	180mm (7")	1.6mm	2.5mm	>4.0mm	3
T3867 8	200mm (8")	2.0mm	2.8mm	>4.0mm	3



Redline Wire Stripper

Micro adjustment for damage free, repeatable results. Spring assisted opening for convenience. ISO 5743

Item No.			
T3754	160mm (6")	0.3 - 5.0mm	3



Redline Snipe Nose Pliers

Serrated inside jaws for secure gripping. ISO 5745

Item No.					
T3909 5	140mm (5 1/2")	1.2mm	1.6mm	>4.0mm	3
T3909 6	170mm (6 3/4")	1.4mm	1.9mm	>4.0mm	3
T3906 8	200mm (8")	1.6mm	2.0mm	>4.0mm	3



Cutter, Snipe & Combination Pliers Set

CONTENTS: Combination Pliers 180mm, Side Cutters 160mm, Snipe Nose Pliers 200mm.

Item No.	
T3803	1



Redline Bent Nose Pliers

Serrated inside jaws for secure gripping. Bent nose for special access needs. ISO 5745

Item No.					
T3907 8	200mm (8")	1.6mm	2.0mm	>4.0mm	3



Cutter, Snipe & Stripping Pliers Set

CONTENTS: Wire Stripping Pliers 160mm, Side Cutters 160mm, Snipe Nose Pliers 200mm.

Item No.	
T3804	1

Classic™

Professional general purpose pliers & cutters

1. Induction hardened jaws for outstanding long term performance.
2. High alloy steel, drop forged, hardened and tempered for exceptional strength and durability.
3. Heads polished and lacquered for corrosion protection.
4. Wipe clean PVC handles for added convenience.

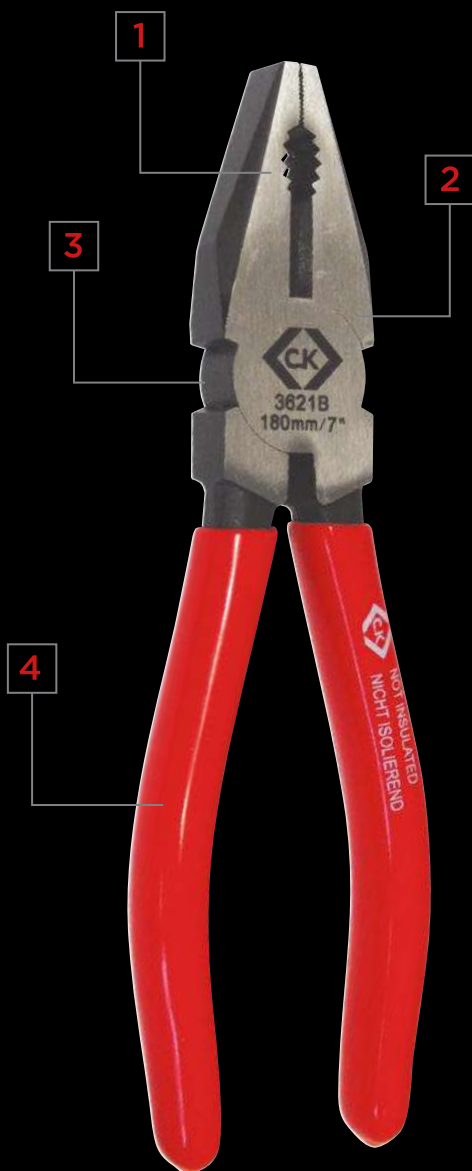

Classic



Classic Side Cutters

Induction hardened cutting jaws with optimised geometry for unsurpassed cutting performance.

ISO 5749

Item No.	Length	Wire	Tube	Sheet	Box
T3623B 5	140mm (5 1/2")	1.2mm	1.6mm	>4.0mm	6
T3623B 6	160mm (6")	1.6mm	2.1mm	>4.0mm	6



Classic Heavy Duty Side Cutters

High leverage design for increased cutting capacity.

ISO 5749

Item No.	Length	Wire	Tube	Sheet	Box
T3627B 7	180mm (7")	2.2mm	3.8mm	>6.0mm	6



Classic Combination Pliers

Precision engineered jaws for exceptional grip. Extra long cutting edges for increased cutting capacity.

ISO 5746

Item No.	Length	Wire	Tube	Sheet	Box
T3621B 6	160mm (6")	1.6mm	2.5mm	>4.0mm	6
T3621B 7	180mm (7")	1.6mm	2.5mm	>4.0mm	6
T3621B 8	200mm (8")	2.0mm	2.8mm	>4.0mm	6



Classic Snipe Nose Pliers

Serrated inside jaws for secure gripping.
ISO 5745

Item No.					
T3626B 8	200mm (8")	1.6mm	2.0mm	>4.0mm	6



Classic Cable Cutters

Special alloy steel construction with razor sharp, induction hardened cutting edges for outstanding cutting performance. Shearing action for clean cut results. Special profile blade for effective cable cutting & wire stripping. Suitable for copper & aluminium wire only.

Item No.			
T3963 160	160mm (6")	9mm	3
T3963	210mm (8 1/4")	11mm	3
T3963 240	240mm (9 1/2")	13mm	3

Waterpump Pliers



Waterpump Pliers

Special alloy steel, drop forged, hardened & tempered for exceptional strength & durability. Induction hardened jaws for outstanding long term performance. Box joint design with double pivot support for strength. Slim head & jaws for access to confined spaces. Contoured anti-slip handles for comfortable & powerful operation.

Item No.			
T3650 250	250mm (10")	47mm	3



Waterpump Pliers - Standard

Special alloy steel, drop forged, hardened & tempered for exceptional strength & durability. Induction hardened jaws for outstanding long term performance. Laid on slip joint design for secure adjustment.

DIN ISO 8976

Item No.			
T3651 09	250mm (10")	38mm (1 1/2")	3



Push Button Waterpump Pliers

Push button adjustment for quick and secure jaw adjustment. Long slim head & jaws for access to confined spaces. Extra wide jaws for greater working capacity. Chrome vanadium alloy steel, drop forged, hardened & tempered for exceptional strength & durability. Box joint for extra stability.

Item No.			
T3653 180	180mm (7")	42mm	6
T3653 250	250mm (10")	50mm	6
T3653 300	300mm (12")	70mm	6



Heavy Duty Waterpump Pliers

Special alloy steel, drop forged, hardened & tempered for exceptional strength & durability. Box joint design with double pivot support for strength. Slim head & jaws for access to confined spaces. Contoured anti-slip handles for comfortable & powerful operation.

DIN ISO 8976

Item No.			
T3659A 175	180mm (7")	25mm (1")	3
T3659A 240	240mm (9 1/2")	32mm (1 1/4")	3
T3659A 300	300mm (12")	45mm (1 3/4")	3



Ratchet crimping pliers

1. Auto-stop ratchet system releases when correct pressure is applied to ensure precise crimping.
2. Precision engineered dies for quality crimps and safe connections.
3. Dies manufactured from fully hardened carbon alloy steel for strength and durability.
4. Heavy duty construction, tested up to 40,000 cycles, guaranteed for 30,000 crimps per tool.
5. Ergonomic two component handle for ease and comfort in use.



High Capacity Waterpump Pliers

Special alloy steel, drop forged, hardened & tempered for exceptional strength & durability. Induction hardened jaws for outstanding long term performance. 11 adjustment point, non slip groove joint mechanism with a large 110mm jaw capacity. Slim head & jaws for access to confined spaces. Contoured anti-slip handles for comfortable & powerful operation.

Item No.			
T3629A 400	400mm	110mm (4")	1

Crimping Pliers



Terminal Crimper .25-2.5mm 2K

Designed for the safe and secure crimping of green, red, and blue insulated terminals. Also suitable for green, red and blue butt and parallel splicers.

Item No.		
T3680A	✓	3



Terminal Crimper 0.5-6mm 2K

Designed for the safe and secure crimping of red, blue and yellow insulated terminals. Also suitable for red, blue and yellow butt and parallel splicers.

Item No.		
T3682A	✓	3



Terminal Crimper 1-10mm 2K

Designed for the safe and secure crimping of uninsulated terminals.

Item No.		
T3697A	✓	3



Ferrule Crimper 0.14-2.5mm 2K

Designed for the safe and secure crimping of small bootlace ferrules.

Item No.		
T3692A	✓	3



Auto Bootlace Crimping Plier

For boot lace ferrules - 0.08 - 16mm² / 28 - 6 AWG. Self adjusting jaws automatically sizes to the ferrule being crimped. Range selector switch - for quick adjustment. Ergonomic two-component handle - for comfort. Ratchet release lever and pressure adjustment - for ease of use. High compression pressure - for secure crimping. Deadlock system - for safe and precise crimping.

Item Number	mm ² / AWG	
T3695	0.08 - 16mm ² / 28 - 6 AWG	3



Ferrule Crimper 10-25mm 2K

Designed for the safe and secure crimping of large bootlace ferrules.

Item No.		
T3683A	✓	3



Bell Mouth Crimper 6-25mm 2K

Designed for the safe and secure crimping of bell mouth ferrules.

Item No.			mm ² / AWG	
T3676A	✓	350mm	6 - 25 / 10 - 4	3



Modular Crimper 4/6/8P 2K

Designed for the safe and secure crimping of Modular Plugs 4P, 6P and 8P. Built in wire stripper and cutters for convenience.

Item No.		
T3681A	✓	3



Ferrule Crimper 0.25-6mm 2K

Designed for the safe and secure crimping of medium bootlace ferrules.

Item No.		
T3684	✓	3



Coax, BNC, TNC Crimper 2K

Designed for the safe and secure crimping of COAX - BNC and TNC connectors.

Item No.		
T3698A	✓	3



Modular Crimper 6/8P 2K

Designed for the safe and secure crimping of Modular Plugs 6P and 8P. Built in wire stripper and cutters for convenience.

Item No.		
T3852A	✓	3



Solar PV Crimper 2K

Designed for the safe and secure crimping of Solar PV cable connectors.

Item Number			
T3671A	MC3 & MC4	220mm	3
T3677	4 - 10mm ² / 12 - 8 AWG		3



Pass Through Modular Crimper 8P 2K

Cuts, strips, crimps and trims pass through Modular Plugs 8P Capacity 8P8C (RJ45).

Item No.		
T3853	✓	3



Coax, BNC, TNC Crimper

Designed for the safe & secure crimping of BNC/TNC connectors to coaxial cable.

Item No.			
430026	✓	230mm	3



Compact Modular Crimper 6/8P

Compact ergonomic design for convenient storage and easy handling. Crimps both 6 and 8 position modular connectors (including RJ11 and RJ45). Cuts and strips CAT3, CAT5e and flat cables. Heavy duty carbon steel body for strength and durability.

Item Number				
T3673	✓	6P & 8P	140mm	3
T3673A		6P / 8P		3



Crimping Pliers

Designed for the safe & secure crimping of bootlace ferrules. Hardened & tempered high alloy carbon steel for increased strength & durability. Matte chrome plated for corrosion protection. Contoured grips with anti-slip horns for comfort & safety.

Item No.				
430005	✓	145mm	0.25 - 2.5 / 23 - 13	3
430006	✓	220mm	0.5 - 16 / 20 - 5	3



Multi-Function Crimping Plier

Specially hardened steel for durability, with black soft comfort grips. Four function tool for wire cutting, wire stripping, crimping and bolt/wire shearing.

Item Number			
430024	250mm	Crimping of non-insulated terminals (Red, Blue & Yellow) Bolt shearing (0.75, 1.5, 2.5, 4, 6mmØ) Wire Stripping (0.75, 1.0, 1.5, 2.5, 4, 6mmØ) Soft wire cutting.	3

Heavy Duty Cutters



Ratchet Cable Cutter

Compact heavy duty cutter for clean effortless cutting. High quality chrome molybdenum profiled steel blade. Ratchet disengage lever for quick cable loading. Integral locking mechanism for safe storage. Designed to cut hard drawn copper cable, aluminium cable or 200 pair communication cables.

Item No.			
430007	190mm	32mm	3
Z3677 1	Moving blade		1
Z3677 2	Fixed blade		1



Heavy Duty Ratchet Cable Cutter

High-grade special tool steel cutting jaws, forged and hardened for an extended working life. Heavy duty ratchet action for the effortless cutting of large diameter cable. Suitable for copper and aluminium cables up to 52mmØ and SWA cable up to 36mmØ.

Item No.			
T3678	52mm Cu/Al	36mm SWA	1
Z3678 1	Moving blade		1
Z3678 2	Fixed blade		1



Heavy Duty Cable Shears

High-grade special tool steel cutting jaws, forged and hardened for an extended working life. Parrot-beak cutting jaws to prevent cable slippage. For large diameter copper and aluminium cables up to 27mmØ.

Item No.		
T3679	27mm	1



Wire Rope Cutter

Heavy duty construction, drop forged alloy steel, hardened & tempered for exceptional strength & durability. Induction hardened specially profiled shearing blades for clean cutting of a wide range of wire & cables including: bowden cable, steel wire, fencing wire; stranded wire rope, copper & aluminium cables, steel rods, etc. PVC coated handles for comfort and grip.

Item No.				
T3744	190mm	6mm	4mm	10



Wire Cutters - Heavy Duty

Heavy duty construction, drop forged alloy steel, hardened & tempered for exceptional strength & durability. Induction hardened jaws for outstanding long term performance. Wipe clean PVC handles for added convenience. Black lacquered for corrosion protection.

Item No.			
T3961A 08	200mm (8")	2.0mm	3
T3961A 10	250mm (10")	3.0mm	5



Bolt Cutters

For cutting round material and hard wire up to 40HRC. Head and cutting edges manufactured from hot drop forged chrome vanadium steel. Induction hardened cutting edges, plastic coated tubular handles. Replacement heads are separately available.

Item No.	↔	∅ 785Nmm ² (51TONS SQ ²)	∅ 1226Nmm ² (80TONS SQ ²)	📦
T4358 12	340mm (13")	6mm	5mm	1
T4358 15	400mm (16")	7mm	6mm	1
T4358 18	450mm (18")	10mm	7mm	1
T4358 25	610mm (24")	11mm	9mm	1
T4358 36	900mm (35")	15mm	13mm	1
Z4358 121	Spare 12" Jaw			1
Z4358 151	Spare 15" Jaw			1
Z4358 181	Spare 18" Jaw			1
Z4358 251	Spare 25" Jaw			1
Z4358 301	Spare 30 & 36" Jaw			1



Bolt Cutters - Pocket

Compact cutters ideal for fencing, meshes and low tensile wire. Hot drop forged chrome vanadium steel jaws with induction hardened cutting edges for strength and durability. Compound action mechanism applies extreme cutting forces.

Item No.	↔	∅ 785Nmm ² (51TONS SQ ²)	∅ 1226Nmm ² (80TONS SQ ²)	📦
T4371A	250mm (10")	5mm	3mm	2

Pincers & Top Cutters



Pincers

Optimised jaw design for effective gripping & extracting of screws, nails, fixings, etc. Specially profiled cutting blades for cutting metal rod & wire. High alloy steel, drop forged, hardened & tempered for exceptional strength & durability. Wipe clean PVC handles. Black lacquered for corrosion protection.

Item No.	↔	●	◐	📦
T4108A 06	160mm (6")	2.0mm	>4.0mm	3
T4108A 07	180mm (7")	2.0mm	>4.0mm	3
T4108A 08	200mm (8")	2.0mm	>4.0mm	3



Top Cutters - Standard

High alloy steel, drop forged, hardened & tempered for strength & durability. Induction hardened jaws for outstanding long term cutting performance. Wipe clean PVC handles for added convenience. Black lacquered for corrosion protection.

Item No.	↔	●	◐	◑	📦
T3988 180	180mm (7")	2.5mm	3.2mm	>4.0mm	3
T3988 200	200mm (8")	2.8mm	3.5mm	>4.0mm	3



Top Cutters - Steel Fixers

Special slimline design for binding & twisting wire. Induction hardened jaws for outstanding long term cutting performance. High alloy steel, drop forged, hardened & tempered for exceptional strength & durability. Wipe clean PVC handles for added convenience. Black lacquered for corrosion protection.

Item No.	↔	◐	📦
T4112A 08	220mm (8 1/4")	2.0mm	1
T4112A 10	250mm (10")	2.0mm	3
T4112A 11	280mm (11")	2.0mm	3

Conduit Cutters



Ratcheting Conduit Cutter

Heavy duty aluminium body - strong & light. Ratchet action razor sharp stainless steel blade for effortless cutting of: PVC conduit, blue water mains, plastic pipe, rubber hose, pneumatic pipe, electrical sleeving, etc. Complete with special adaptor for straight or mitre cutting of small rectangular cross-section trunking.

Item No.			
430003	220mm	32mm	3
Z2239B			



PVC Pipe & Conduit Cutter

Glass fibre reinforced polycarbonate body - strong & light. Razor sharp stainless steel blade for efficient cutting of: PVC conduit, blue water mains, plastic pipe, rubber hose, pneumatic pipe, electrical sleeving, etc.

Item No.			
430001	195mm	28mm	3



Ratchet Multifunction Cutter

Heavy duty aluminium body. Lever action razor sharp stainless steel blade for effortless cutting of: PVC conduit, blue water mains, plastic pipe, rubber hose, pneumatic pipe, electrical sleeving, wooden dowel, etc. 5 interchangeable anvils (flat, double radius, single radius, 90° square and mitre). Allow a variety of cross sections to be cut, both straight and mitred.

Item No.		
T2240		3
Z2240 1	Spare Blade	1
Z2240 2	Multi-Angle Anvil	1
Z2240 3	90° Anvil	1
Z2240 4	Flat Anvil	1
Z2240 5	25mm Anvil	1
Z2240 6	16/19mm Anvil	1

Pipe Cutters



Pipe Cutter

Adjustable pipe cutter for copper, brass, aluminium and thin walled steel pipe. Easy grip handle. New longer life easy glide steel insert body threads. Replaceable hardened steel cutting blade for long life performance. No tools required for convenience. Black die cast lacquered body for strength and corrosion resistance.

Item No.		
T2231A	3 - 30mm	5



Mini Pipe Cutter

Compact adjustable mini pipe cutter for copper, brass, aluminium and thin walled steel pipe. New longer life easy glide steel insert body threads. Replaceable hardened steel cutting blade for long life performance. No tools required for convenience. Black die cast lacquered body for strength and corrosion resistance.

Item No.		
T2232A	3 - 25mm	10



Pipe Cutter - Spare Wheel

Suitable for T2231 & T2232 Pipe Cutters.

Item No.		
T2235	19.5mm	10

Circlip Pliers



Circlip Pliers - Inside Straight

High alloy steel, drop forged, hardened & tempered for exceptional strength & durability. Chequered handles for grip. DIN 5256C

Item No.	↔	∅	DIN	📦
T3710 0	140mm (5 1/2")	8 - 13mm	J0	5
T3710 5	140mm (5 1/2")	12 - 25mm	J1	5
T3710 7	180mm (7")	19 - 60mm	J21	5
T3710 8	220mm (8 1/4")	40 - 100mm	J3	5
T3710 11	300mm (12")	85 - 140mm	J4	5



Circlip Pliers - Outside Straight

High alloy steel, drop forged, hardened & tempered for exceptional strength & durability. Chequered handles for grip. DIN 5254A

Item No.	↔	∅	DIN	📦
T3711 0	140mm (5 1/2")	3 - 10mm	A0	5
T3711 5	140mm (5 1/2")	10 - 25mm	A1	5
T3711 7	180mm (7")	19 - 60mm	A2	5
T3711 8	220mm (8 1/4")	40 - 100mm	A3	5
T3711 11	300mm (12")	85 - 140mm	A4	5



Circlip Pliers - Inside Bent

High alloy steel, drop forged, hardened & tempered for exceptional strength & durability. Chequered handles for grip. DIN 5256D

Item No.	↔	∅	DIN	📦
T3712 5	140mm (5 1/2")	12 - 25mm	J11	5
T3712 7	180mm (7")	19 - 60mm	J21	5
T3712 8	220mm (8 1/4")	10 - 100mm	J31	5



Circlip Pliers - Outside Bent

High alloy steel, drop forged, hardened & tempered for exceptional strength & durability. Chequered handles for grip. DIN 5256B

Item No.	↔	∅	DIN	📦
T3713 0	140mm (5 1/2")	3 - 10mm	A01	5
T3713 5	140mm (5 1/2")	10 - 25mm	A11	5
T3713 7	180mm (7")	19 - 60mm	A21	5
T3713 8	220mm (8 1/4")	40 - 100mm	A31	5



Circlip Pliers - Adjustable

Push button changeover from inside to outside configuration for convenience.

Item No.	📦
T3716	3

Snips



Cable Snips

Designed for fast and efficient cutting of aluminium & copper wires and plastic sheathed cables. Stainless steel razor sharp shearing blades for outstanding cutting performance. Spring assisted blade opening with safety closing catch for convenience. PVC coated handles for comfort and grip.

Item No.			
430008	165mm (6 1/2")	10mm	3



Tin Snips

Forged alloy steel for strength & durability. Hardened & tempered jaws for high cutting performance. Stop pin to prevent finger nipping during use.

Item No.		
T4536 08	200mm (8")	3
T4536 10	250mm (10")	3



Compound Action Snips

Compound action, high leverage design for easy cutting of steel, stainless steel, titanium etc. Forged chrome molybdenum steel jaws, hardened and tempered for long term cutting performance. Ergonomic grips with slip guards for safety. Blades configured for either, right hand curve, left hand curve or straight cuts.

Item No.			
T4537AS	240mm (10")	Straight	3
T4537AL	240mm (10")	Left	3
T4537AR	240mm (10")	Right	3
Z4537 1			

Riveting Pliers



Riveting Pliers

Heavy duty steel construction for exceptional strength & durability. Colour coded interchangeable nose bushes for convenience (nose spanner included). 3 jaw mechanism for increased grip and outstanding long term performance - 50% greater gripping strength than a standard 2 jaw riveter. Ergonomic anti-slip handles.

Item No.		
T3820	260mm (10 1/2")	3
T3820AS		1



Riveting Plier Nozzles

Nozzles for T3820.

Item No.		
Z3820 12	1/8"	1
Z3820 15	5/32"	1
Z3820 18	3/16"	1



Lazy Tong Riveter

Heavy duty steel construction for exceptional strength & durability. Anti shock design protects from injuries to wrist, arm or shoulder. Cushion grip handle for superior grip & comfort. Colour coded interchangeable nose bushes.

Item No.		
T3822A	305 - 780mm (12 - 32 1/2")	1
Z3822A/34	Set of 3 Jaws	1



Rivets - Aluminium (Pack of 50)

Colour coded for simple size identification.

Item No.		
T3819A 408	3.15 x 6mm (1/8 x 1/4")	15
T3819A 412	3.15 x 9mm (1/8 x 3/8")	15
T3819A 415	3.15 x 12mm (1/8 x 1/2")	15
T3819A 508	4 x 6mm (5/32 x 1/4")	15
T3819A 512	4 x 9mm (5/32 x 3/8")	15
T3819A 515	4 x 12mm (5/32 x 1/2")	15
T3819A 612	4.8 x 16mm (3/16 x 3/8")	15
T3819A 615	4.8 x 16mm (3/16 x 1/2")	15
T3819A 620	4.8 x 16mm (3/16 x 5/8")	15



Washers (Pack of 100)

Galvanised steel for corrosion resistance.

Item No.		
T3824 12	3.15mm (1/8")	6
T3824 15	4mm (5/32")	6
T3824 18	4.8mm (3/16")	6

Punch Pliers



Revolving Punch Pliers

Specially hardened steel punches and brass anvil for long term cutting performance. 6 punch revolving head marked with size for convenience. Black lacquered coating for corrosion protection. Suitable for leather, plastic, card, etc.

Item No.		
T3817	220mm (8 1/4")	5

Fencing Pliers



Fencing Pliers

Heavy duty multi-purpose tool to hammer and draw out staples; strains, twists and splices wire. Manufactured to the original German pattern. High grade steel polished head. Red PVC handles.

Item No.			
T3866	270mm (10 5/8")	645g	3



Screwdrivers

Dextro VDE	31
Dextro VDE Slim	32
Stubby VDE Slim	35
Dextro	37
Triton XLS	41
Ratchet Screwdrivers	43
Impact Drivers	43
Magnetiser / Demagnetiser	43
HD Classic	45

dextroTM VDE

Premium quality
insulated screwdrivers

1. Tip type marking for easy identification.
2. Ergonomically shaped, dual component handle for increased comfort, control and safety.
3. Long fine neck for precise fingertip control.
4. Ridges along the head give extra grip in that last 1/4 turn.
5. Handle injection moulded directly to blade giving the ultimate bond for increased reliability and durability.
6. VDE approved - individually tested to 10,000V for safe live working up to 1,000V.
7. Premium quality chrome vanadium steel blade for exceptional strength and durability.
8. Precision machined tip for an exact screw fit and damage free screwdriving.

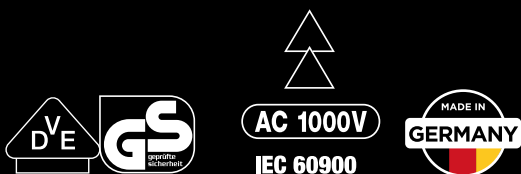
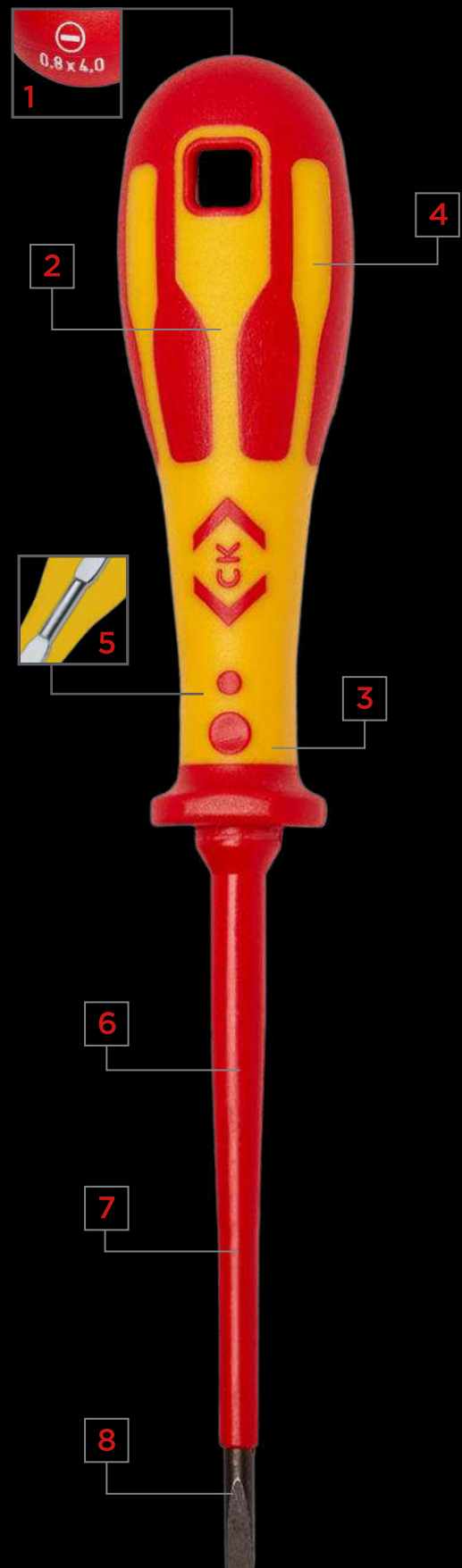

Conforms to IEC 60900. Approved and
independently audited by the German VDE institute.

Dextro VDE



VDE Screwdrivers - Slotted Parallel

BS EN 60900, VDE0682/201, ASTM-F 1505, ISO 2380-2

Item No.					
T49144-025	2.5mm (3/32")	75mm (3")	0.4mm (0.016")	95mm (3 3/4")	6
T49144-030	3.0mm (1/8")	100mm (4")	0.5mm (0.020")	95mm (3 3/4")	6
T49144-035	3.5mm (9/64")	100mm (4")	0.6mm (0.024")	95mm (3 3/4")	6
T49144-040	4.0mm (5/32")	100mm (4")	0.8mm (0.031")	107mm (4 1/32")	6
T49144-055	5.5mm (7/32")	125mm (5")	1.0mm (0.039")	120mm (4 3/4")	6
T49144-065	6.5mm (1/4")	150mm (6")	1.2mm (0.047")	120mm (4 3/4")	6
T49144-080	8.0mm (5/16")	175mm (7")	1.2mm (0.047")	135mm (5 1/16")	6
T49144-100	10.0mm (25/64")	200mm (8")	1.6mm (0.063")	135mm (5 1/16")	6



VDE Screwdrivers - Pozidriv

BS EN 60900, VDE0682/201, ASTM-F 1505, DIN ISO 8764

Item No.					
T49143-0	PZ0	3.5mm (9/64")	60mm (2 3/8")	95mm (3 3/4")	6
T49143-1	PZ1	5.0mm (3/16")	80mm (3 1/8")	107mm (4 1/32")	6
T49143-2	PZ2	6.0mm (15/64")	100mm (4")	107mm (4 1/32")	6
T49143-2200	PZ2	6.0mm (15/64")	200mm (8")	120mm (4 3/4")	6
T49143-3	PZ3	8.0mm (5/16")	150mm (6")	135mm (5 1/16")	6



VDE Screwdrivers - Phillips

BS EN 60900, VDE0682/201, ASTM-F 1505, DIN ISO 8764

Item No.					
T49142-0	PH0	3.5mm (9/64")	60mm (2 3/8")	95mm (3 3/4")	6
T49142-1	PH1	5.0mm (3/16")	80mm (3 1/8")	107mm (4 1/32")	6
T49142-2	PH2	6.0mm (15/64")	100mm (4")	120mm (4 3/4")	6
T49142-3	PH3	8.0mm (5/16")	150mm (6")	135mm (5 1/16")	6



VDE Screwdrivers - Modulo

BS EN 60900, VDE0682/201, ASTM-F 1505

Item No.					
T49145-1	1	5.0mm (3/16")	80mm (3 1/8")	107mm (4 1/32")	6
T49145-2	2	6.0mm (15/34")	100mm (4")	120mm (4 3/4")	6



VDE Screwdriver Set/2 - Modulo

CONTENTS: Modulo 1 x 80mm & Modulo 2 x 100mm.

BS EN 60900, VDE0682/201, ASTM-F 1505

Item No.			
T49146	1 & 2		6



VDE Screwdriver Set/5 - SLP/PH

CONTENTS: 3 x slotted parallel, sizes: 2.5 x 75, 4 x 100 & 5.5 x 125mm. 2 x Phillips, sizes: PH1 x 80 & PH22 x 100mm.
BS EN 60900, VDE0682/201, ISO 2380-2, DIN ISO 8764

Item No.	i	⊖	⊕	📦
T49182D	Set of 5	2.5, 4.0 & 5.5mm	PH 1 & 2	18



VDE Screwdriver Set/7 - SLP/PZ

CONTENTS: 4 x slotted parallel, sizes: 2.5 x 75, 4 x 100, 5.5 x 125 & 6.5 x 150mm. 3 x Pozidriv, sizes: PZ0 x 60, PZ1 x 80 & PZ2 x 100mm.
BS EN 60900, VDE0682/201, ISO 2380-2, DIN ISO 8764

Item No.	i	⊖	⊕	📦
T49193D	Set of 7	2.5, 4.0, 5.5 & 6.5	PZ 0, 1 & 2	18



VDE Screwdriver Set/7 - SLP/PH

CONTENTS: 4 x slotted parallel, sizes: 2.5 x 75, 4 x 100, 5.5 x 125mm & 6.5 x 150mm. 3 x Phillips, sizes: PH0 x 60, PH1 x 80 & PH2 x 100mm.
BS EN 60900, VDE0682/201, ISO 2380-2, DIN ISO 8764

Item No.	i	⊖	⊕	📦
T49192D	Set of 7	2.5, 4.0, 5.5 & 6.5mm	PH 0, 1 & 2	18



VDE Screwdriver Set/5 - SLP/PZ

CONTENTS: 3 x slotted parallel, sizes: 2.5 x 75, 4 x 100 & 5.5 x 125mm. 2 x Pozidriv, sizes: PZ1 x 80 & PZ2 x 100mm.
BS EN 60900, VDE0682/201, ISO 2380-2, DIN ISO 8764

Item No.	i	⊖	⊕	📦
T49183D	Set of 5	2.5, 4.0 & 5.5mm	PZ 1 & 2	18

Dextro VDE Slim



VDE Slim Screwdrivers - Slotted

BS EN 60900, VDE0682/201, ASTM-F 1505, ISO 2380-2

Item No.	⊖	↔	⊖	↔	📦
T49244-035	3.5mm (9/64")	100mm (4")	0.6mm (0.024")	95mm (3 3/4")	6
T49244-040	4.0mm (5/32")	100mm (4")	0.8mm (0.031")	95mm (3 3/4")	6
T49244-055	5.5mm (7/32")	125mm (5")	1.0mm (0.039")	107mm (4 1/8")	6



VDE Slim Screwdrivers - Pozidriv

BS EN 60900, VDE0682/201, ASTM-F 1505, DIN ISO 8764

Item No.	⊕	⊖	↔	↔	📦
T49243-1	PZ1	5.0mm (3/16")	100mm (4")	95mm (3 3/4")	6
T49243-2	PZ2	6.0mm (15/64")	125mm (5")	107mm (4 1/8")	6



Premium quality insulated screwdrivers

The C.K DextroVDE Slim screwdrivers provide easy access to recessed screws. Eliminating the need to remove insulation and compromise safety, they are slim enough to fit into the tightest of spaces, yet still offer outstanding torsional strength and active torque feedback for an extended working life.

1. Slim shafted insulated blades - allow access to recessed screws and fixings.
2. VDE approved - individually tested to 10,000V for safe working up to 1,000V.
3. German manufactured - quality and performance assured.
4. Dual component, ergonomic handle - specifically designed for use by electricians.
5. Premium quality chrome vanadium steel blades - for exceptional strength and durability.

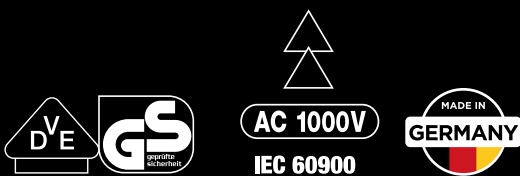

Conforms to IEC 60900. Approved and independently audited by the German VDE institute.



VDE Slim Screwdrivers - Phillips

BS EN 60900, VDE0682/201, ASTM-F 1505, DIN ISO 8764

Item No.	+	∅	↔	↔	📦
T49242-1	PH1	5.0mm (3/16")	100mm (4")	95mm (3 3/4")	6
T49242-2	PH2	8.0mm (5/16")	125mm (5")	107mm (4 1/2")	6



VDE Slim Screwdrivers - Modulo

BS EN 60900, VDE0682/201, ASTM-F 1505

Item No.	⊛	∅	↔	↔	📦
T49245-1	MOD1	5.0mm (3/16")	100mm (4")	95mm (3 3/4")	6
T49245	MOD1.5	5.0mm (3/16")	100mm (4")	95mm (3 3/4")	6
T49245-2	MOD2	6.0mm (15/34")	125mm (5")	107mm (4 1/2")	6



VDE Slim Screwdriver Set

CONTENTS: 3 x slotted parallel, sizes: 3.5 x 100, 4 x 100 & 5.5 x 125mm. 2 x Pozidriv, sizes: PZ1 x 100 & PZ2 x 125mm.

BS EN 60900, VDE0682/201, ISO 2380-2, DIN ISO 8764

Item No.	i	⊖	⊛	📦
T49283D	Set of 5	3.5, 4.0 & 5.5mm	PZ 1 & 2	18



VDE Slim Glo Screwdriver Set

Glow in the dark handles. Never lose your tools again.

CONTENTS: 3 x slotted parallel, sizes: 3.5 x 100, 4 x 100 & 5.5 x 125mm. 2 x Pozidriv, sizes: PZ1 x 100 & PZ2 x 125mm

BS EN 60900, VDE0682/201, ISO 2380-2, DIN ISO 8764

Item No.	i	⊖	⊛	📦
T49283PD	Set of 5	3.5, 4.0 & 5.5mm	PZ 1 & 2	18



VDE Slim Interchangeable Screwdriver Set

VDE approved - individually tested to 10,000V for safe working up to 1,000V. Soft grip handles for increased comfort. Quick lock mechanism for quick and easy blade interchange. Toughened alloy steel blades for exceptional durability. Compact fabric storage pouch with integral belt loop. Slim shafted 1000V insulated blades allow access to recessed screws and fixings.

BS EN 60900, VDE0682/201, ASTM-F 1505, ISO 2380-2, DIN ISO 8764

Item Number	i	i	📦
T4925	Set of 7		1
T4935	Set of 16		6
T4925S35	Slotted 3.5mm	Replacement Blade	10
T4925S45	Slotted 4.5mm	Replacement Blade	10
T4925S60	Slotted 6.0mm	Replacement Blade	10
T4925PZ1	Pozidriv 1	Replacement Blade	10
T4925PZ2	Pozidriv 2	Replacement Blade	10
T4925MOD1	Modulo 1	Replacement Blade	10
T4925MOD2	Modulo 2	Replacement Blade	10
T4935PH1	PH1	Replacement Blade	6
T4935PH2	PH2	Replacement Blade	6
T4935S55	Slotted 5.5mm	Replacement Blade	6
T4935S65	Slotted 6.5mm	Replacement Blade	6
T4935T10	T10	Replacement Blade	6
T4935T15	T15	Replacement Blade	6
T4935T20	T20	Replacement Blade	6
T4935T25	T25	Replacement Blade	6

Stubby VDE Slim



Stubby VDE Slim Screwdrivers - Slotted

EN 60900, VDE0682/201, ASTM-F 1505

Item No.					
T48344-040	4.0mm (5/32")	46mm (1 13/16")	0.8mm (0.031")	60mm (2 23/64")	6
T48344-055	5.5mm (7/32")	46mm (1 13/16")	1.0mm (0.039")	60mm (2 23/64")	6



Stubby VDE Slim Screwdriver - Pozidriv

EN 60900, VDE0682/201, ASTM-F 1505

Item No.					
T48343-2	PZ 2	6.0mm (15/64")	46mm (1 13/16")	60mm (2 23/64")	6



Stubby VDE Slim Screwdriver - Modulo

EN 60900, VDE0682/201, ASTM-F 1505

Item No.					
T48345-2	MOD 2	6.0mm (15/34")	46mm (1 13/16")	60mm (2 23/64")	6



Stubby VDE Slim Screwdriver Set/4

CONTENTS: T48344-040 SL4.0mm x 1, T48344-050 SL5.5mm x 1, T48343-2 PZ2 x 1, T48345-2 MOD x 1

EN 60900, VDE0682/201, ASTM-F 1505

Item No.		
T48349	Set of 4	20



VDE Screwdrivers

1. Ideal for use in confined spaces.
2. Slim shafted insulated blades ~ allow access to recessed screws and fixings.
3. VDE approved ~ individually tested to 10,000V for safe working up to 1,000V.
4. Premium quality chrome vanadium steel blades for exceptional strength and durability.



Conforms to IEC 60900. Approved and independently audited by the German VDE institute.



dextro™

Premium quality screwdrivers

1. Tip type marking for easy identification.
2. Ergonomically shaped, dual component handle for increased comfort, control and safety.
3. Long fine neck for precise fingertip control.
4. Ridges along the head give extra grip in that last 1/4 turn.
5. Handle injection moulded directly to blade giving the ultimate bond for increased reliability and durability.
6. Premium quality chrome vanadium steel blade for exceptional strength and durability.
7. Precision machined tip for an exact screw fit and damage free screwdriving.







Dextro



Dextro Screwdrivers - Slotted Parallel



ISO 2380-2

Item No.					
T49125-025	2.5mm (3/32")	75mm (3")	0.4mm (0.061")	95mm (3 3/4")	6
T49125-030	3.0mm (1/8")	75mm (3")	0.5mm (0.020")	95mm (3 3/4")	6
T49125-03025	3.0mm (1/8")	250mm (10")	0.5mm (0.020")	95mm (3 3/4")	6
T49125-035	3.5mm (9/64")	100mm (4")	0.6mm (0.024")	95mm (3 3/4")	6
T49125-040	4.0mm (5/32")	125mm (5")	0.8mm (0.031")	107mm (4 7/32")	6
T49125-055	5.5mm (7/32")	150mm (6")	1.0mm (0.039")	120mm (4 3/4")	6



Dextro Screwdrivers - Pozidriv





ISO 8764

Item No.					
T49113-0	PZ0	3.5mm (9/64")	60mm (23/8")	95mm (3 3/4")	6
T49113-1	PZ1	5.0mm (3/16")	75mm (3")	107mm (4 7/32")	6
T49113-1250	PZ1	5.0mm (3/16")	250mm (10")	107mm (4 7/32")	6
T49113-2	PZ2	6.0mm (15/64")	150mm (6")	120mm (4 3/4")	6
T49113-2250	PZ2	6.0mm (15/64")	250mm (10")	120mm (4 3/4")	6
T49113-3	PZ3	8.0mm (5/16")	150mm (6")	135mm (5 1/16")	6



Dextro Screwdrivers - Slotted Flared

ISO 2380-2

Item No.					
T49110-040	4.0mm (5/32")	75mm (3")	0.8mm (0.031")	107mm (4 7/32")	6
T49110-055	5.5mm (7/32")	100mm (4")	1.0mm (0.039")	120mm (4 3/4")	6
T49110-065	6.5mm (1/4")	150mm (6")	1.2mm (0.047")	120mm (4 3/4")	6
T49110-100	10.0mm (25/64")	200mm (8")	1.6mm (0.063")	135mm (4 3/16")	6



Dextro Screwdrivers - Phillips

ISO 8764

Item No.	+	∅	↔	↔	📦
T49112-0	PH0	3.5mm (9/64")	60mm (2 3/8")	95mm (3 3/4")	6
T49112-1	PH0	5.0mm (3/16")	80mm (3 1/8")	107mm (4 1/2")	6
T49112-1250	PH1	5.0mm (3/16")	250mm (10")	107mm (4 1/2")	6
T49112-2	PH2	6.0mm (15/64")	100mm (4")	120mm (4 3/4")	6
T49112-2250	PH2	6.0mm (15/64")	250mm (10")	120mm (4 3/4")	6
T49112-3	PH3	8.0mm (5/16")	150mm (6")	135mm (5 1/16")	6



Dextro Screwdrivers - Robertson

Item No.	□	∅	↔	↔	📦
T49118-1	Size 1	6.0mm (15/64")	125mm (5")	120mm (4 3/4")	6
T49118-2	Size 2	6.0mm (15/64")	125mm (5")	120mm (4 3/4")	6
T49118-3	Size 3	6.0mm (15/64")	125mm (5")	120mm (4 3/4")	6



Dextro Screwdrivers - Torx

Item No.	⊕	∅	↔	↔	📦
T49117-06	T 06	3.0mm (1/8")	70mm (2 3/4")	95mm (3 3/4")	6
T49117-07	T 07	3.0mm (1/8")	70mm (2 3/4")	95mm (3 3/4")	6
T49117-08	T 08	3.0mm (1/8")	70mm (2 3/4")	95mm (3 3/4")	6
T49117-09	T 09	3.0mm (1/8")	70mm (2 3/4")	95mm (3 3/4")	6
T49117-10	T 10	3.0mm (1/8")	80mm (3 1/8")	107mm (4 1/2")	6
T49117-15	T 15	3.5mm (9/64")	80mm (3 1/8")	107mm (4 1/2")	6
T49117-20	T 20	4.0mm (5/32")	90mm (3 1/2")	107mm (4 1/2")	6
T49117-25	T 25	4.5mm (11/64")	90mm (3 1/2")	107mm (4 1/2")	6
T49117-27	T 27	5.5mm (7/32")	110mm (4 1/4")	120mm (4 3/4")	6
T49117-30	T 30	6.0mm (15/64")	110mm (4 1/4")	120mm (4 3/4")	6
T49117-40	T 40	7.0mm (9/32")	120mm (4 3/4")	135mm (5 1/16")	6



Dextro Screwdriver Set/5 - SL/PZ

CONTENTS: 3 x slotted flared, sizes: 4 x 75, 5.5 x 100 & 6.5 x 150mm. 2 x Pozidriv, sizes: PZ1 x 80 & PZ2 x 100mm.

ISO 2380-2, DIN ISO 8764

Item No.	i	⊖	⊕	📦
T49153	Set of 5	4.0, 5.5 & 6.5mm	PZ1 & PZ2	1



Dextro Screwdriver Set/7 - SL/PZ

CONTENTS: 3 x slotted flared, sizes: 4 x 75, 5.5 x 100 & 6.5 x 150mm. 1 x slotted parallel, size: 3.0 x 75mm. 3 x Pozidriv, sizes: PZO x 60, PZ1 x 80 & PZ2 x 100mm.

ISO 2380-2, DIN ISO 8764

Item No.	i	⊖	⊕	📦
T49163D	Set of 7	3.0, 4.0, 5.5 & 6.5mm	PZO, 1 & 2	18



Dextro Screwdriver Set/7 - SL/PH

CONTENTS: 3 x slotted flared, sizes: 4 x 75, 5.5 x 100 & 6.5 x 150mm. 1 x slotted parallel, size: 3 x 75mm. 3 x Phillips, sizes: PH0 x 60, PH1 x 80 & PH2 x 100mm.

ISO 2380-2, DIN ISO 8764

Item No.	i	⊖	⊕	📦
T49162D	Set of 7	3.0, 4.0, 5.5 & 6.5mm	PH0, 1 & 2	18



Professional general purpose screwdrivers

1. Tip type marking for easy identification.
2. Large soft grip tri-lobe handle for exceptional comfort and high torque turns.
3. Handle injection moulded directly to blade giving the ultimate bond for increased reliability and durability.
4. Anti roll flats to prevent the screwdriver rolling off sloping surfaces.
5. Chrome plated, toughened alloy steel blade for increased strength and durability.
6. Magnetic tip holds the screw securely to the tip to aid positioning and setting.



Triton XLS



Triton Screwdrivers - Slotted Parallel

ISO 2380-2

Item No.					
T4725-030	3.0mm (1/8")	75mm (3")	0.6mm (0.024")	89mm (3 3/8")	6
T4725-040	4.0mm (5/32")	100mm (4")	0.8mm (0.031")	100mm (4")	6
T4725-055	5.5mm (7/32")	250mm (10")	1.0mm (0.039")	100mm (4")	6



Triton Screwdrivers - Slotted Flared

ISO 2380-2

Item No.					
T4720-055	5.5mm (7/32")	100mm (4")	1.0mm (0.039")	100mm (4")	6
T4720-065	6.5mm (1/4")	150mm (6")	1.2mm (0.047")	108mm (4 1/4")	6
T4720-100	10mm (25/64")	200mm (8")	1.6mm (0.063")	118mm (4 5/8")	6



Triton Screwdrivers - Phillips

Item No.					
T4722-0	PH0	3.0mm (1/8")	60mm (2 3/8")	89mm (3 3/8")	6
T4722-1	PH1	5.0mm (3/16")	75mm (3")	100mm (4")	6
T4722-1250	PH1	5.0mm (3/16")	250mm (10")	100mm (4")	6
T4722-2	PH2	6.0mm (15/64")	100mm (4")	108mm (4 1/4")	6
T4722-2250	PH2	6.0mm (15/64")	250mm (10")	108mm (4 1/4")	6
T4722-3	PH3	8.0mm (5/16")	150mm (6")	118mm (4 5/8")	6



Triton Screwdrivers - Pozidriv

Item No.					
T4723-0	PZ0	3.0mm (1/8")	60mm (2 3/8")	89mm (3 3/8")	6
T4723-1	PZ1	5.0mm (3/16")	75mm (3")	100mm (4")	6
T4723-1250	PZ1	5.0mm (3/16")	250mm (10")	100mm (4")	6
T4723-2	PZ2	6.0mm (15/64")	100mm (4")	108mm (4 1/4")	6
T4723-2250	PZ2	6.0mm (15/64")	250mm (10")	108mm (4 1/4")	6
T4723-3	PZ3	8.0mm (5/16")	150mm (6")	118mm (4 5/8")	6



Flexible Shafted Screwdriver

Strong yet flexible shaft for access to screws and fixings in awkward places. Soft grip tri-lobe handle for exceptional comfort and control. Magnetic bit holder for positive bit retention. For use with 6mm - 1/4" hexagon screwdriver bits (not included).

Item No.				
T4760	200mm	110mm	6mm	6
T4760CBOX				1



Triton Screwdriver Bit Holder

Large softgrip tri-lobe handle for high torque applications. Strong and corrosion resistant stainless steel sleeve. Magnetic base and c-ring securely retains the bit in place.

Item No.		
T4516	6mm (1/4")	12



Triton Screwdriver Set/5 - SL/PH

CONTENTS: 2 x slotted flared, sizes: 5.5 x 100 & 6.5 x 150mm. 1 x slotted parallel, size: 4 x 100mm. 1 x Phillips, sizes: PH1 x 75 & PH2 x 100mm.

ISO 2380-2, DIN ISO 8764

Item No.	
T4726	1



Triton Screwdriver Set/5 - SL/PZ

CONTENTS: 2 x slotted flared, sizes: 5.5 x 100 & 6.5 x 150mm. 1 x slotted parallel, size: 4 x 100mm. 2 x Pozidriv, sizes: PZ1 x 75 & PZ2 x 100mm.

ISO 2380-2, DIN ISO 8764

Item No.	
T4727	1



Insulated Triton Set/5 - SL/PH

CONTENTS: 3 x slotted parallel, sizes: 2.5 x 75, 4 x 100 & 5.5 x 125mm. 2 x Phillips, sizes: PH1 x 80 & PH x 100mm.

BS EN 60900, ISO 2380-2, DIN ISO 8764

Item No.	
T4728	1



Insulated Triton Set/5 - SL/PZ

CONTENTS: 3 x slotted parallel, sizes: 2.5 x 75, 4 x 100 & 5.5 x 125mm. 2 x Pozidriv, sizes: PZ1 x 80 & PZ2 x 100mm.

BS EN 60900, ISO 2380-2, DIN ISO 8765

Item No.	
T4729	1
T4729CBOX	1



Electric Torque Screwdriver

Put some power into any screw driving task with the T4930 E-driver from C.K Tools. Let the rechargeable high torque motor do the hard work, perfect for repetitive tasks such as tightening or loosening panel screws or socket face plates. Helps you to conserve energy and reduce fatigue when on site. Compact and light weight design fits in any tool case. 3.6V USB-C rechargeable E-Screwdriver. Torque dial gives clear and precise motor adjustment (1-6Nm). Ergonomic body for superior comfort and grip. Forward and backward rotation via easy reach buttons. Manual operation up to 20Nm. 6.35mm locking hex chuck with quick release. 2000 mAh battery for up to 200mins run time. 1hr charge time with battery level indicator. PZ2/SL4 double-sided screwdriver bit included. Tool tether loop for safe tool retention.

Item Number	Length	Torque	Run Time	Charge Time	Capacity
T4930	195mm	1 - 6Nm	200 mins	1hr	40

Ratchet Screwdrivers



Ratchet Screwdriver/Socket Set

Hi-torque ratchet mechanism for durability. Left & right hand rotation plus lock action for convenience. Magnetic shaft for secure bit retention. Cushion grip handle with convenient internal bits storage compartment. CONTENTS: Ratchet screwdriver, Sockets: 6, 7, 8, 10, 11 and 13mm / 3/16, 1/4, 5/16, 11/32, 3/8 and 7/16", Slotted: 3 / 4 / 4.5 / 5 / 6 / 7 / 8 and 9mm, Phillips: PH0, PH1, PH2 and PH3, Pozidriv: PZ0, PZ1, PZ2 and PZ3, Tamperproof TX: T8, T10, T15, T20, T25, T27, T30 and T40, Hexagon: 1.5 / 2 / 2.5 / 3 / 4 / 5 / 5.5 and 6mm, 1/4" adaptor.

Item No.	i	📦
T4826D	Set of 46	3



Ratchet Screwdriver & Bits Set

Magnetic shaft for secure bit retention. Hi-torque ratchet mechanism with left & right hand rotation plus lock action. Supplied with 10 bits. Cushion grip handle with convenient internal bits storage compartment. CONTENTS: Ratchet screwdriver. Screwdriver bits: 1 x slotted, sizes: 3.0, 4.7 & 6.3mm. 1 x PH, size: 1 x PZ, sizes: 1, 2 & 1 x hexagon, sizes: 3, 4 & 5mm.

Item No.	i	📦
T4829D	Set of 11	3

Impact Drivers



Impact Screwdriver & Bits Set

Heavy duty steel body - strong and durable. Chrome plated for corrosion protection. Shock absorbing grip for comfort & protection. Twist to reverse function for convenience. High strength chrome vanadium bits. Steel case for convenient storage. CONTENTS: Impact driver, 1/2" to 1/4" drive adaptor, Screwdriver bits: 1 x slotted, sizes: 8 & 10mm, 1 x Phillips, sizes: 2 & 3

Item No.	i	📦
T4928	Set of 6	2
T4928 362		10
T4928 363		10
T4928 802		10
T4928 803		10
T4928 36P2		10
T4928 36P3		10
T4928 36M08		10
T4928 36M10		10
T4928 36M12		10

Magnetiser / Demagnetiser



Magnetiser/Demagnetiser

To induce magnetism in screwdrivers, tweezers, etc. Pass slowly through lower (+) section. To remove magnetism, pass through upper (-) section. Display Packed.

Item No.	📦	📦
T1350	90g	3

HD classic

Classic heavy duty screwdrivers

1. Shatter resistant acetate handle - wipe clean, oil and acid resistant.
2. Large square shape handle design for maximum torque.
3. Handle injection moulded directly to blade giving the ultimate bond for increased reliability and durability.
4. Anti roll flats to prevent the screwdriver rolling off sloping surfaces.
5. Chrome plated toughened alloy steel blade for increased strength and durability.
6. Precision machined tip for an exact screw fit and damage free screwdriving.

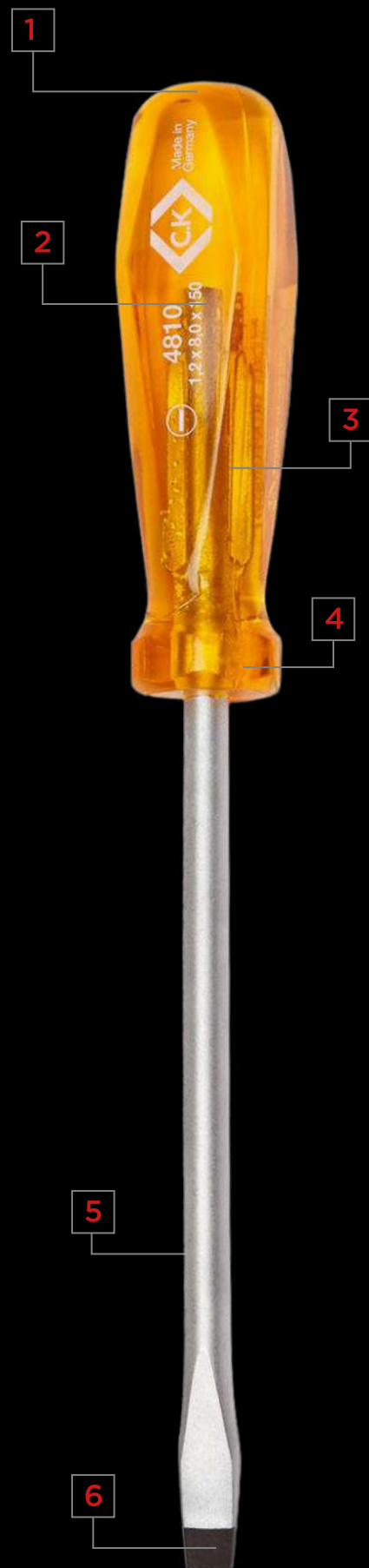

HD Classic



HD Screwdrivers - Slotted Parallel

ISO 2380-2

Item No.					
T4965 03	3mm (1/8")	75mm (3")	0.5mm (0.02")	70mm (2 3/4")	6
T4965 04	4mm (5/32")	100mm (4")	0.8mm (0.03")	80mm (3 1/8")	6
T4965 05	4.5mm (11/64")	125mm (5")	0.8mm (0.03")	80mm (3 1/8")	6
T4965 06	5mm (3/16")	150mm (6")	0.8mm (0.03")	90mm (3 1/2")	6
T4965 08	5mm (3/16")	200mm (8")	0.8mm (0.03")	90mm (3 1/2")	6
T4965 12	6mm (15/64")	300mm (12")	1.0mm (0.04")	100mm (4")	6



HD Long Screwdrivers - Slotted Parallel

ISO 2380-2

Item No.					
T4975 06	3mm (1/8")	150mm (6")	0.5mm (0.02")	80mm (3 1/8")	6
T4975 08	3mm (1/8")	200mm (8")	0.5mm (0.02")	80mm (3 1/8")	6
T4975 10	4mm (5/32")	250mm (10")	0.8mm (0.03")	80mm (3 1/8")	6



HD Screwdrivers - Slotted Flared

ISO 2380-2

Item No.					
T4810 03	5mm (3/16")	75mm (3")	0.8mm (0.03")	90mm (3 1/2")	6
T4810 04	6mm (15/64")	100mm (4")	1.0mm (0.04")	100mm (4")	6
T4810 05	7mm (9/32")	125mm (5")	1.0mm (0.04")	100mm (4")	6
T4810 06	8mm (5/16")	150mm (6")	1.2mm (0.05")	110mm (4 1/4")	6
T4810 08	9mm (11/32")	200mm (8")	1.2mm (0.05")	120mm (4 3/4")	6
T4810 10	10mm (3/8")	250mm (10")	1.6mm (0.06")	130mm (5 1/8")	6
T4810 12	12mm (1/2")	300mm (12")	2.0mm (0.08")	130mm (5 1/8")	6



HD Screwdrivers - Strike Through

Strike through design for the most demanding applications.

ISO 2380-2

Item No.					
T4811 04	6mm (15/64")	100mm (4")	1.0mm (0.04")	100mm (4")	6
T4811 06	8mm (5/16")	150mm (6")	1.2mm (0.05")	110mm (4 1/4")	6
T4811 08	10mm (3/8")	200mm (8")	1.6mm (0.06")	120mm (4 3/4")	6
T4811 10	13mm (1/2")	250mm (10")	2.0mm (0.08")	130mm (5 1/8")	6



HD Screwdrivers - Phillips

DIN ISO 8764

Item No.	+	Ø			
T4812 0	PH0	3.5mm (9/64")	65mm (2 1/2")	70mm (2 3/4")	6
T4812 1	PH1	5mm (3/16")	80mm (3 1/8")	90mm (3 1/2")	6
T4812 2	PH2	6mm (15/64")	100mm (4")	100mm (4")	6
T4812 3	PH3	8mm (5/16")	150mm (6")	110mm (4 1/4")	6
T4812 4	PH4	10mm (3/8")	200mm (8")	120mm (4 3/4")	6



HD Long Screwdrivers - Pozidriv

ISO 8764

Item No.	+	Ø			
T4987 1	PZ1	5mm (3/16")	250mm (10")	100mm (4")	6
T4987 2	PZ2	6mm (15/64")	250mm (10")	110mm (4 1/4")	6



HD Stubby Screwdrivers - Slotted

ISO 2380-2

Item No.					
T4814 25	6.5mm (1/4")	25mm (1")	1.2mm (0.05")	60mm (2 3/8")	6
T4814 31	8mm (5/16")	25mm (1")	1.2mm (0.05")	60mm (2 3/8")	6



HD Long Screwdrivers - Phillips

ISO 8764

Item No.	+	Ø			
T4977 1	PH1	5mm (3/16")	250mm (10")	100mm (4")	6
T4977 2	PH2	6mm (15/64")	250mm (10")	110mm (4 1/4")	6



HD Stubby Screwdrivers - Phillips

DIN ISO 8764

Item No.	+	Ø			
T4815 1	PH1	5mm (3/16")	25mm (1")	60mm (2 3/8")	6
T4815 2	PH2	6mm (15/64")	25mm (1")	60mm (2 3/8")	6

HD Screwdrivers - Pozidriv

DIN ISO 8764

Item No.	+	Ø			
T4813 0	PZ0	3.5mm (9/64")	60mm (2 1/2")	70mm (2 3/4")	6
T4813 1	PZ1	5mm (3/16")	80mm (1/8")	90mm (3 1/2")	6
T4813 2	PZ2	6mm (15/64")	100mm (4")	100mm (4")	6
T4813 3	PZ3	8mm (5/16")	150mm (6")	110mm (4 1/4")	6
T4813 4	PZ4	10mm (3/8")	200mm (8")	120mm (4 3/4")	6



HD Stubby Screwdrivers - Pozidriv

DIN ISO 8764

Item No.					
T4816 1	PZ1	5mm (3/16")	25mm (1")	60mm (2 3/8")	6
T4816 2	PZ2	6mm (15/64")	25mm (1")	60mm (2 3/8")	6



HD Screwdriver Bit Holder

High strength stainless steel magnetic bit holder for 1/4" bits.

Item No.	
T4581	6



HD Nut Spinners

Extra deep socket for reaching nuts through which bolts protrude.

DIN 3125

Item No.				
T4334M 03	3mm	130mm (5 1/8")	90mm (3 1/2")	3
T4334M 035	3.5mm	130mm (5 1/8")	90mm (3 1/2")	3
T4334M 04	4mm	130mm (5 1/8")	90mm (3 1/2")	3
T4334M 045	4.5mm	130mm (5 1/8")	90mm (3 1/2")	3
T4334M 05	5mm	130mm (5 1/8")	90mm (3 1/2")	3
T4334M 055	5.5mm	130mm (5 1/8")	90mm (3 1/2")	3
T4334M 06	6mm	130mm (5 1/8")	90mm (3 1/2")	3
T4334M 07	7mm	130mm (5 1/8")	100mm (4")	3
T4334M 08	8mm	130mm (5 1/8")	100mm (4")	3
T4334M 09	9mm	130mm (5 1/8")	100mm (4")	3
T4334M 10	10mm	130mm (5 1/8")	100mm (4")	3
T4334M 11	11mm	120mm (4 3/4")	110mm (4 1/4")	3
T4334M 12	12mm	120mm (4 3/4")	110mm (4 1/4")	3
T4334M 13	13mm	120mm (4 3/4")	110mm (4 1/4")	3



HD Screwdriver Set/8 - SLF/PZ

CONTENTS: 4 x slotted flared, sizes: 6 x 100, 6.5 x 25, 7 x 125 & 8 x 100mm. 2 x slotted parallel, sizes: 3 x 75 & 4 x 100mm. 2 x Pozidriv, sizes: PZ1 x 80 & PZ2 x 100mm.

ISO 2380-2, DIN ISO 8764

Item No.	
T4999B	3



CK
MIGHTY RODS
Mighty-Rods 10m Cable
Agrees to the file Mighty
Mighty-Rods Sec, 10m

375 kg
Tensile
Strength

CRIPLE FIBRE
WILLOW
CONNECTION
glued, indented, crimped

10 x 10
(6mm)

OPTIMAL BLEND
of rigidity & flexibility

HIGH SHEEN ROD
anti-slag, anti-splatter

Cable Routing

MightyRods PRO	51
MightyScope	52
MightyRods	52
Cable Routing	54
Draw Tapes	54





Next gen advanced technology

MightyRods PRO cable rods encompass a fusion of advanced technological features that deliver the ultimate in cable rod performance.

Improving on-the-job efficiency, MightyRods PRO cable rods get the job done.



100% SPLINTER PROOF RODS

SplinterSHIELD is an advancement in cable rod technology. The durable SplinterSHIELD coating fully encases the inner fibreglass rod to prevent harmful splintering.



UNSURPASSED STRENGTH

Through the use of an innovative triple fixing system, the super tough zinc-plated steel Mighty-Fix connectors offer unsurpassed tensile strength in excess of 275kg. Furthermore, the ultra-slim profile reduces snagging and provides accessibility through smaller holes.

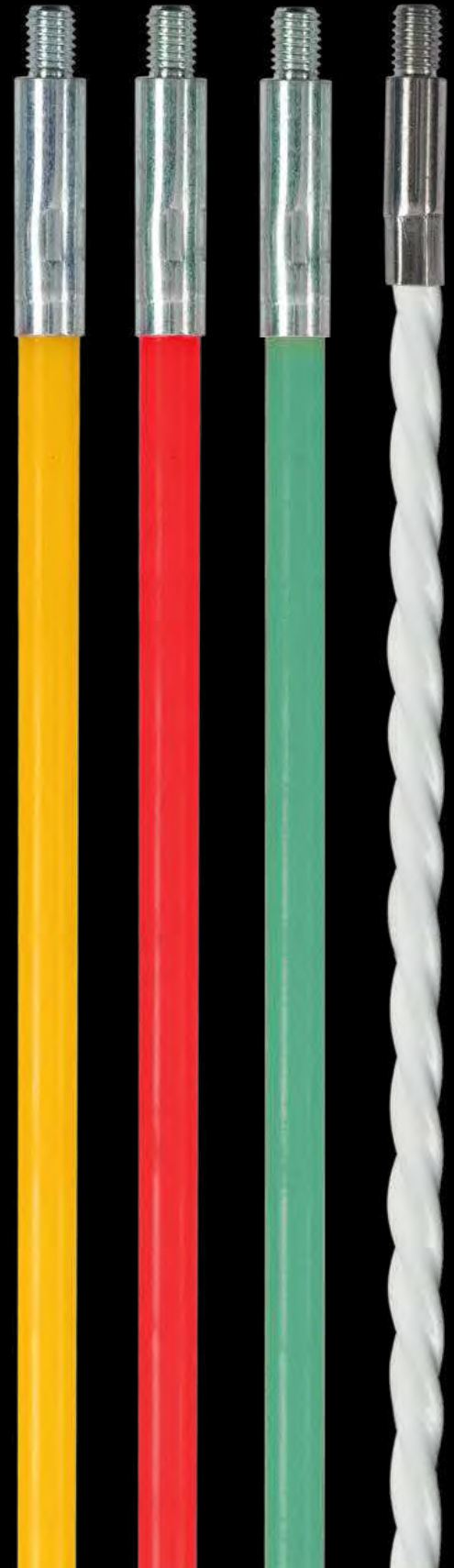

MightyRods PRO



MightyRods PRO 12m Super Set

12 meters of 100% splinter-proof rods. 4 rod flexibilities for overhead, under floor, tight angled and obstructed runs. Super flexible, low friction, Spira-FLEX rod for tight angled access points. Glow in the dark phosphorescent GLO rod for guiding a run of rods in low light conditions. Accessories: flexi-lead (mini-flex), ring, hook, gender changer, flat bullet, domed bullet, in-line swivel, torch, magnet, chain. CONTENTS: 2 x 1m rods 7mmØ / 8 x 1m rods 6mmØ / 1 x Rod SpiraFLEX 4mmØ / 1 x rod GLO 6mmØ / 1 x FlexiLead / 1 x Hook / 1 x Flat Bullet / 1 x Domed Bullet / 1 x Magnet / 1 x Ring / 1 x Gender Changer / 1 x In-line Swivel / 1 x Torch / 1 x Chain.

Item No.		
T5422	12 x 1m	1



MightyRods 3pc Accessory Pack

Upgrade your MightyRod kit with this Super Kit upgrade pack. CONTENTS: Torch, Magnet and Chain.

Item No.		
T5441	3pc	1



MightyRods PRO Cable Socks

Tapered woven steel mesh cable sock that provides a quick and secure method for securing cables to rods.

Item No.		
T5442 06	6 - 10mm	6
T5442 11	11 - 15mm	6



MightyRods PRO 10m Standard Set

10 meters of 100% splinter-proof rods. 4 rod flexibilities for overhead, under floor, tight angled and obstructed runs. Super flexible, low friction, Spira-FLEX rod for tight angled access points. Accessories: flexi lead (mini-flex), ring, hook, gender changer, flat bullet, domed bullet, in-line swivel. CONTENTS: 2 x 1m rods 7mmØ / 7 x 1m rods 6mmØ / 1 x Rod SpiraFLEX 4mmØ / 1 x FlexiLead / 1 x Hook / 1 x Flat Bullet / 1 x Domed Bullet / 1 x Ring / 1 x Gender Changer / 1 x In-line Swivel.

Item No.		
T5421	10 x 1m	1



MightyRods PRO 5m Starter Set

5 meters of 100% splinter-proof rods. 2 rod flexibilities for overhead, under floor, tight angled and obstructed runs. Accessories: flexi lead (mini-flex), ring, hook. CONTENTS: 5 x 1m rods of 6mmØ / 1 x Flexi Lead / 1 x ring / 1 x Hook.

Item No.		
T5420	5 x 1m	1



MightyRods PRO 3.3m Toolbox Set

Slimline connectors reduce snagging and provide accessibility through smaller holes. 33cm rods are ideal for tight access applications. Convenient sized set for storage in tool box or tool bag. CONTENTS: 10 x 330mm rods with 6 mm Ø / 1 x flexible rod 190mm / 1 x ring / 1 x hook / 5mm adaptor.

Item No.		
T5419	10 x 330mm	1



MightyRods PRO 6mm Rods - 2 Pack

A pair of flexible 6mmØ rods ideal for most common routing needs.

Item No.	Ø	i		
T5430	6mm	Flexible		1



MightyRods PRO 7mm Rods - 2 Pack

A pair of more rigid 7mmØ rods ideal for overhead runs. They also provide greater control during straight cable runs.

Item No.	Ø	i		
T5431	7mm	Rigid		1



MightyRods PRO 6mm Rod - GLO

A flexible 6mmØ rod, this phosphorescent GLO rod guides the way when routing in low light conditions.

Item No.	Ø	i	i	
T5432	6mm	Flexible	Phosphorescent	1



MightyRods PRO 4mm SpiraFLEX

This super flexible 4mmØ rod is the perfect solution when access is tight or when navigating around obstacles. The innovative helical profile and PET material reduces friction and minimises snagging.

Item No.	Ø	i		
T5433	4mm	Super-Flexible		1



MightyRods 7pc Accessory Pack

A full range of accessories from the MightyRod PRO Standard kit. CONTENTS: 1 x Flexi Lead, Hook, Ring, Gender Changer, Flat Bullet, Domed Bullet and In-line Swivel.

Item No.	i		
T5440	7pc		1

MightyScope



MightyScope Inspection Camera

The MightyScope comes with an onboard Wi-Fi hotspot that will stream in high resolution with a wireless range of up to 15m (50'). High resolution real time HD viewing with the ability to save photos and videos direct to your smart device gallery. The bright white LED's can be adjusted from the App to view in complete darkness when pushed into dark and confined spaces. This helps you investigate and diagnose problems. In the MightyScope App settings select to have the image view either normal view or always up. Digital zoom function - Digital zoom will give you a close up view from your MightyScope camera. Waterproof and dustproof - When the back cap is screwed on, the MightyScope is IP67 rated. Charge time - Quick Charge USB-C. From 0% - 100% battery charge in 100 minutes. Mode runtime - Light off: up to 110 minutes. Dimmed: up to 90 minutes. Full Beam: up to 70 minutes.

EN 55032:2015+A1 2020 EN 61000-3-2:2019+A1 2021 EN 61000-3-3:2013+A1 2019+A2 2021 EN55035:2017+A11:2020 EN301 489-1 V2,2,3 , EN301 489-17 V3,2,4 EN300 328-1 V2,2,2, EN50665:2017, EN IEC 62311:2020 EN IEC 62368-1-2020+A11 2020 EN IEC 62368-1:2020+A11:2020 Protection against Electric Shock - Class III

Item No.	↔	📶	☔	
T5600	94mm x 24mm	15m	IP67	5

MightyRods



MightyRods 10m Cable Rods Set

10 meters of high sheen fibreglass and resin composite rods. Slimline connectors reduce snagging and provide accessibility through smaller holes. 5mmØ rods offer the optimal balance of rigidity and flexibility for the majority of cable routing requirements. CONTENTS: 10 x 1m rods, cable hook, 190mm coiled steel flexi lead, mini eye & ring, 5mm adaptor.

Item No.	↔	Ø	
T5410	10 x 1m	5mm	3



Wireless inspection camera

Featuring adjustable bright white LEDs, HD streaming, built-in Wi-Fi hotspot - wireless and rechargeable, digital zoom function and a free and easy to use app.

Wireless inspection camera for the end user needing to inspect, photograph or record video in locations with limited access or visibility. Can be used with C.K. MightyRods/PRO cable routing products.

- Visual Inspection
- Cable Installation
- Maintenance
- Repair Work
- Job Site Ready

**NEVER
LOSE SIGHT**





MightyRods 3.3m Cable Rods Set

Conveniently sized set for storage in toolbox or tool bag. Ideal for tight access applications. Combined total length of 3.3m. 5mmØ rods offer the optimal blend of rigidity & flexibility. CONTENTS: 10 x 330mm rods, cable hook, 190mm coiled steel flexi lead, mini eye & ring, thread adaptor.

Item No.		
T5411		10



MightyRods Carry Case

Durable polyester construction with reinforced base. Adjustable shoulder strap for convenient carrying. Two external pockets: Large pocket, capable of accommodating C.K MightyRods Toolbox cable rod set. Small pocket, to accommodate cable rod accessories.

Item No.		
T5450	1200mm	1

Cable Routing



Gloworm Cable Router

Ideal for running cables around tight corners, through insulation filled walls, underneath flooring and across ceilings. Natural curvature aids routing around short tight bends - can also be straightened out for straight line runs. Innovative glow in the dark phosphorescent polymer construction aids routing in low light conditions.

Item No.		
T5460	4m	5

Draw Tapes



SpiraFLEX Draw Tapes

Innovative spiral design significantly reduces frictional resistance allowing for longer cable runs. Manufactured from an advanced polyethylene terephthalate (PET) material - super flexible and immensely tough. Considerably less kinking and coiling compared to nylon and steel tapes. Compatible with C.K MightyRod accessories. Supplied within a protective impact resistant rewindable cassette.

Item No.			
T5510	10m	4mm	3
T5520	20m	4mm	3
T5530	30m	4mm	3



Steel Wire Draw Tape - 50m

Superior quality draw tape. Steel core wire for exceptional tensile strength. POM (Polyoxymethylene) coating for abrasion resistance and minimal friction when pulling cable. Flexible head attachment for navigating conduit with multiple bends.

Item No.			
495055	50m (164ft)	5.5mm	10



POM Draw Tape - 30m

High quality draw tape constructed of three intertwining POM (Polyoxymethylene) strands. Helical tape structure for reduced friction and high tensile strength. Flexible head attachment for navigating conduit with multiple bends. Robust plastic casing for convenience during storage and transportation.

Item No.			
495056	30m (98ft)	6mm	10



Nylon Draw Tapes

Nylon draw tape for low friction and high strength during cable pulling applications. Flexible head attachment for navigating conduit with multiple bends. Red coloured tape for improved visibility in conduit with existing cables. Robust plastic casing for convenience during tape rewind, storage and transportation. Non-conductive properties for safe working practices.

Item No.			
495050	10m (33ft)	4mm	5
495051	15m (49ft)	4mm	5
495052	20m (66ft)	4mm	5
495053	25m (82ft)	4mm	5
495054	30m (98ft)	4mm	5



Draw Eye for Draw Tapes - 4mm

Draw Eye for pulling cable through conduit. For Draw Tapes with a diameter of 4mm.

Item No.		
495058	4mm	100



Flexible Head and Draw Eye - 4mm

Flexible head for guiding cable through conduit. Draw Eye for pulling cable through conduit. For Draw Tapes with a diameter of 4mm. CONTENTS: 1 x flexible head / 1 x draw eye.

Item No.		
495057	4mm	100



Electricians Draw Tape Reel

For pulling cables into conduit tubes. Special flexible spring steel for outstanding strength & reliability. Hooked end for smooth feed & minimal snagging. Housed in a heavy duty dispenser for convenient storage. Integral braking system for non-slip cable pull through.

Item No.		
495008	15.2m (50ft)	1



Electricians Draw Tape

Lead spring guide for smooth feed & minimal snagging. Polymer tape for strength & reliability. Non-conductive & non-corroding for safety & long life.

Item No.		
495005	10m	3
495006	20m	3
495007	30m	2



Draw Tape Lubricant

Reduced friction whilst pulling cable through conduit. Formula: Water, Petroleum Wax, Stabilizer. Store at temperatures between 40-120°F / 4-48°C. Compatible with all common cable insulation materials. Creates a thin, non-conductive film that won't clog conduit. Odourless.

Item No.		
495059	950ml	12

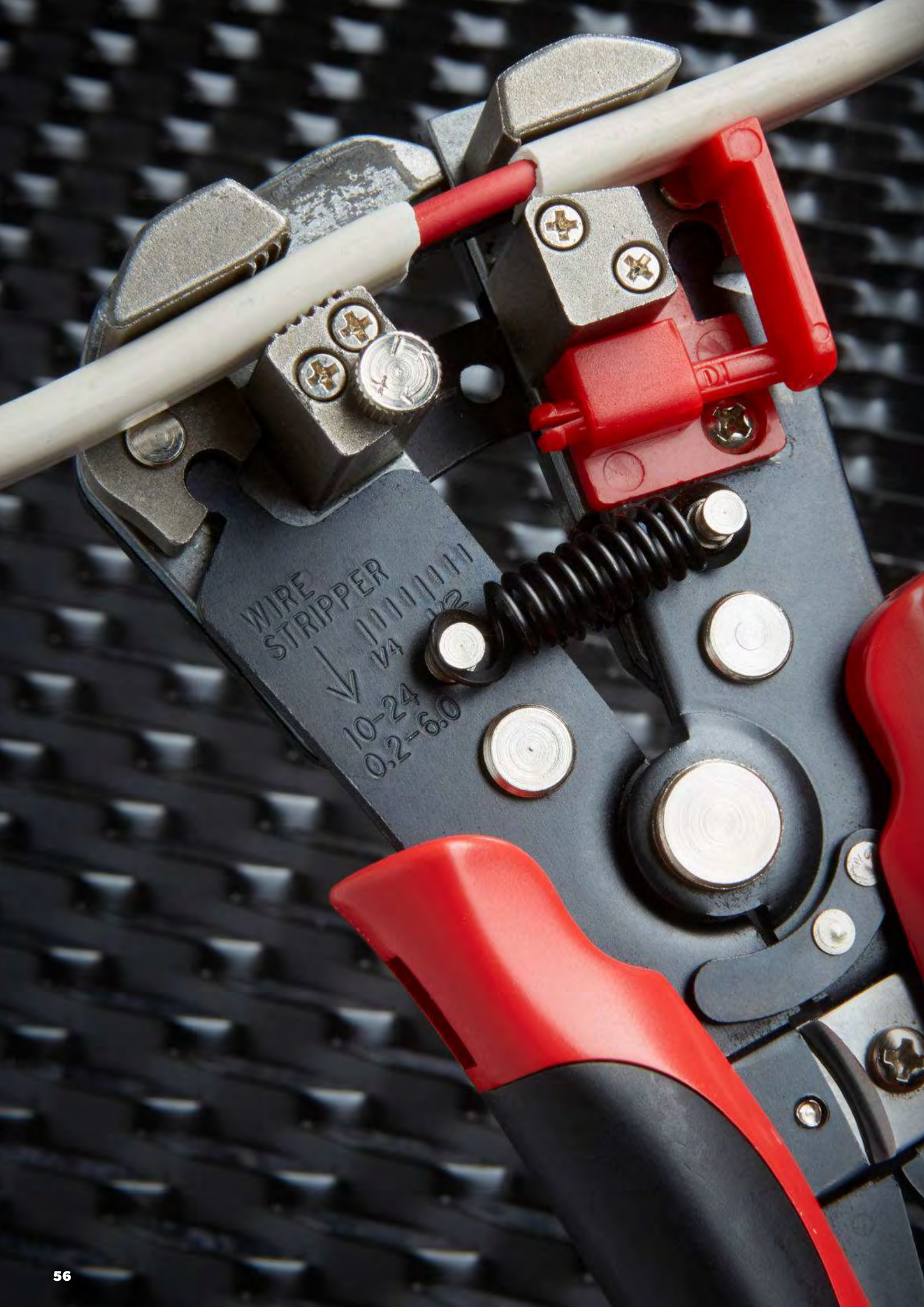

Electricians' Specialist Tools

Cable & Wire Stripping	58
Cable & Wire Cutting	61
Cable Tie Guns	61
Cable Tackers	62
Electrical Installation	63
Mainstesters	63
Voltage Detectors	64
Switch Keys	64
Hexagon Keys	65
Re-Threading Tools	65
Soldering	65



SWA cable stripper

Faster, easier, safer and more efficient thanks to its innovative new "quick clamp" design allowing for rapid tool fitment and removal.

1. Scores armour strands to a uniform depth for a clean break off.
2. Automatic cable clamp applies constant pressure throughout.
3. Finger-grip handle for greater rotational force and faster cutting.
4. Quick release trigger removes clamp from cable with no untightening required.

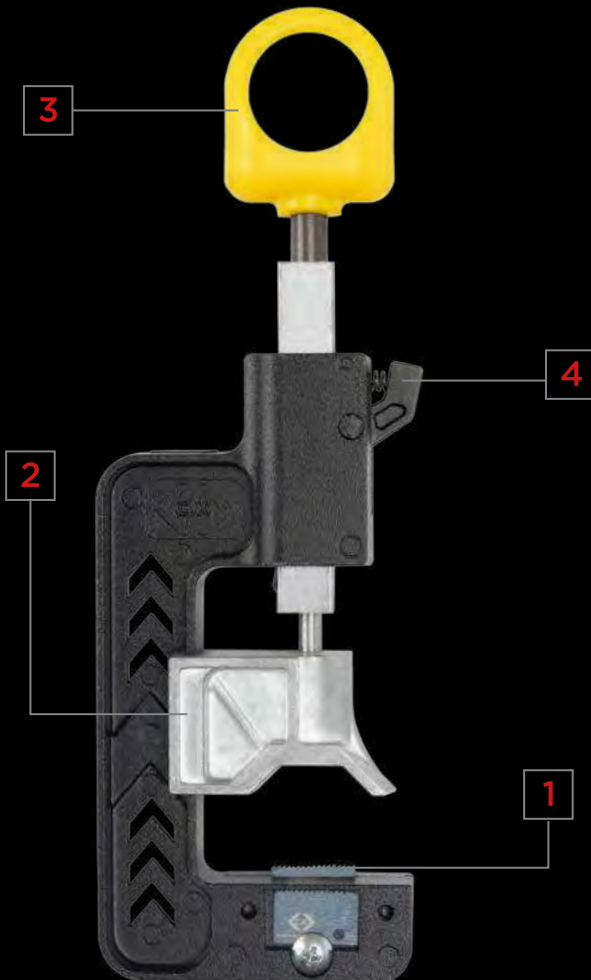

Cable & Wire Stripping



ArmourSlice Evo SWA Cable Stripper

Armourslice EVO is the next generation of SWA Cable stripper in a new and Evolved package. Faster, easier and more efficient thanks to its innovative new "quick clamp" design allowing for rapid tool fitment and removal. Automatic cable clamp applies constant pressure throughout the cut with no retightening necessary. Finger-grip handle for greater rotational force and faster cutting. Scores armour strands to a uniform depth for a clean break off and trouble free gland connection. Quick release trigger removes clamp from cable with no untightening required. Robust metal construction with plated body for exceptional durability and long life performance. High speed steel blade for exceptional cutting performance. x5 replacement blades included with onboard storage. Optimised for armoured cable 12 - 36mmØ.

Item No.	● I	📦
T2250A	12 - 36mmØ	3



5 Spare Blades for ArmourSlice

Replacement blades for ArmourSlice. Pack with 5 blades.

Item No.	📦
T2255	6



ArmourSlice SWA Cable Stripper

Scores armour strands to a uniform depth for a clean break off and trouble free gland connection. Automatic cable clamp applies constant pressure throughout the cut with no retightening necessary. Wide cable clamp ensures perfect blade to cable alignment for precise cuts.

Item No.	● I	📦
T2250	12 - 36mmØ	3





Single Core Auto Wire Stripper

Designed for stripping solid & stranded wires from 0.2 - 6.0mm (24-10 AWG). Automatic wire size adjustment for convenience. Integrated wire cutter. Comfortable dual-compound soft grip handle design. Adjustable length stop (6 - 18mm). Replaceable blades.

Item No.	mm ² / AWG	
T1261	0.2 - 6.0mm / 24 - 10 AWG	8



Coax Cable Stripper

Razor sharp, pre-set stripping blades for fast, precise and damage free stripping of all common coaxial cables. Suitable for stripping cables of 4.8 - 7.5mmØ. Also suitable for stripping 3-core flex. Both ends of tool marked for correct order of use. Dual compound handle for improved grip and safety.

Item No.	Ø	
T1271	4.8 - 7.5mm (3/16 - 19/64")	18



Flat & Round Cable Stripper

Modular - Intelligent bracket change system for all common cable types 4 - 28mm Ø. Universal - Compatible with flat cable 1.5 - 10mm including LSOH/LSF. Built for safety - Recessed blade with protection mechanism reduces injuries. Intuitive Design - Ergonomic handle for increased comfort, unique sight window to monitor cut progress. TÜV AND GS Approved.

Item No.	Ø	
T1290	4 - 28mm (0.16 - 2.75")	150
T1291	1.5 - 10mm inc. LSOH/LSF	60
Z1290 1	2.5mm LSOH/LSF	1
Z1290 2	6mm LSOH/LSF	1
Z1290 3	10mm LSOH/LSF	1



Cable Knife

Blade repositions for cutting both around and along cable sheathing. Adjustable cutting depth to prevent damage to inner conductors. Titanium-Nitride (TIN) coated blade to prolong blade sharpness. Spare cutting blade stored within the handle.

Item No.	Ø	
T1280	8 - 28mm (5/16 - 1 1/8")	6



Universal Cable Stripper

Razor sharp, pre-set stripping blades for fast, precise and damage free stripping of all common round cables. Suitable for stripping cables with 8 - 15mmØ. 2 stripping notches with length stop for stripping conductors. Suitable for stripping wires of 1.5, 2.5mm² (16, 14 AWG). Internal length stop can be re-positioned for left and right hand use.

Item No.	Ø	
T1270	4 - 15mm (3/16 - 9/16")	12



DataComms Cable Stripper

Razor sharp, pre-set stripping blades for fast, precise and damage free stripping of datacomms cables. Pre-set precision stripping blades for damage free conductor stripping.

Item No.	
T1272	140



Automatic Wire Stripper Pro

Replaceable stainless steel cutting blade - for long life. Automatic single action stripping of wires without adjustment - for copper/aluminium wire 0.05 - 8.5mm². Unique two component contoured handle for comfort and secure grip. Micro adjustment knob for precise, repetitive stripping of copper, aluminium wire, solid or stranded.

Item No.	
T3943	8



Fibre Optic Cable Stripper

For fibre-optic, coaxial and other insulated cables with 6 - 25mm diameter. For plastic tubes with 6 - 25mm diameter. Precise setting options: operate with one hand, manual adjustment from circular to longitudinal cuts with swivel lever. Exact positioning of cable in the housing socket prior to stripping. Easy and safe stripping, even through hard outer sheaths. Ergonomic housing made out of high-performance plastic. Replacement blade easily interchangeable. Lightweight.

Item No.	
430009	1



Auto Cable/Wire Stripper

Designed for stripping flat cables up to 12mm in width. Removes both the external sheathing and internal conductor insulation. Automatic size adjustment for convenience. Integrated wire bending hole for termination preparation. Replaceable blades.

Item No.	mm ² /AWG	
T1260	0.75 - 2.5 / 18 - 14 AWG	6



Kabifix Cable Stripper

Dual purpose cable stripper and plastic tube cutting tool. Cutting blade automatically repositions from cutting around, to cutting along the sheath for fast and damage free stripping. Hardened steel blade for outstanding long term performance. High grade polyamide construction - light and strong. Adjustable cutting depth for damage free stripping.

Item No.	Ø	
430004	6 - 28mm	3
395041		10



VDE Cable Sheath Strip Knife

A specially adapted knife for slitting the outer sheath of cables without damaging the inner conductors with a double edged blade to cut on the push and pull stroke. Other features include: Comfortable dual component handle. VDE approved - tested to 10,000V for safe working up to 1,000v. Hardened stainless steel blade. Supplied with protective cap for safe storage.

Item No.		
T0990	185mm (3 1/2")	6

Cable & Wire Cutting



Electricians Knife

Locking pocket knife. With a durable, sharp, stainless steel blade and wire stripping notch for fast and convenient cable & wire stripping.

Item No.		
484001	95mm	3



Electricians Scissors

Heavy duty design for shearing soft cables up to 22mm diameter, insulation materials, tape, cable ties and many other materials. Micro serrated stainless steel blades, hollow ground for self sharpening, superior cutting performance. Integrated cutting notch for effective cable & wire stripping. Belt pouch for convenient storage. Blade length: 42mm.

Item No.		
492001	140mm (5 1/2")	6



Kevlar Scissors

Specially designed for cutting DuPont Kevlar® fibres in fibre optic cables - also suitable for cutting DuPont Kevlar® webbing, plastic canvas, upholstery and many other materials. High carbon alloy steel with molybdenum and vanadium blades, hardened for long lasting cutting performance - guaranteed for up to 1000 cuts. Precision hollow-ground, micro-serrated jaw prevents the fibres from slipping and ensures a clean cut. Ergonomic, thermoplastic moulded handles allow for left and right handed users. Note: DuPont and Kevlar® are trademarks or registered trademarks of E.I. du Pont de Nemours and Company.

Item No.			
T4505	160mm (6 1/4")	90g	12

Cable Tie Guns



Cable Tie Gun

Designed for automatic tensioning and trimming of cable ties. Glass fibre reinforced polyamide construction - light and strong. Tension adjuster for the perfect tensioning of different widths of cable ties. For cable ties from 2.4 - 4.8mm.

Item No.		
495003	2.4 - 4.8mm	12



Cable Tie Gun - Heavy Duty

Designed for automatic tensioning and trimming of cable ties. Heavy duty stainless steel construction for outstanding long term performance. Tension adjuster for the perfect tensioning of different widths of cable ties. Capacity: 4.7 - 13mm cable ties.

Item No.		
495004	4.7 - 13mm	10

Cable Tackers



Cable Tacker - Low Voltage Cable

Heavy duty, tough cast aluminium body for strength & durability. Bi-material ergonomic handle for comfort & reduced fatigue. Unique staple loading & clearing mechanism for fast & convenient use. Handle safety locking system prevents accidental operation. Fires half round staples for use on low voltage cable max 6.4mm diameter (interchangeable with Arrow T25).

Item No.	Diagram	Quantity
T6227	 7.5mm	3



Cable Tacker - Telecom Cable

Heavy duty, tough cast aluminium body for strength & durability. Bi-material ergonomic handle for comfort & reduced fatigue. Unique staple loading & clearing mechanism for fast & convenient use. Handle safety locking system prevents accidental operation. Fires half round staples for use on telecom data cable max 4.8mm diameter.

Item No.	Diagram	Quantity
T6228	 4.8mm	3



Telecom Staples - Half Round

High quality telecom cable staples, galvanised for corrosion protection. White coated tops for discreet fixing - to suit C.K T6228 Telecom cable tacker.

Item No.	Diagram	Quantity
495024	 4.8 x 10mm	10



Cable Staples - Half round

High quality steel cable staples, galvanised for corrosion protection. Suits C.K cable tacker T6227 and compatible versions. 1000 staples.

Item No.	Diagram	Quantity
495022	 7.5 x 14mm	10
495021	 7.5 x 10mm	10

Electrical Installation



Conduit Bush Wrench

Innovative head design allows for all sizes of conduit bushes to be tightened/untightened even with cabling in place. Zinc phosphate coated, tough alloy steel for increased strength and durability. Soft grip, tri-lobe handle for exceptional comfort and control.

Item No.		
T4755	190mm (7 1/2")	6



SWA Gland Wrench

Innovative head design allows for SWA gland nuts to be tightened/untightened even with cabling in place. Zinc phosphate coated, tough alloy steel for increased strength and durability. Soft grip, tri-lobe handle for exceptional comfort and control. Suitable for 20mm & 25mm gland nuts.

Item No.		
T4765	20 & 25mm	6



Punch Down Tool

For the fast and secure seating of data wires into terminals. Suitable for a wide range of terminal block types. One step action for automatic seating & trimming of excess wires. Handle includes wire extractor hook & flat head spudger.

Item No.		
495033	180mm (7")	3



MC4 Solar Spanners

Performance: The perfect solution to tighten and disassemble MC4 connectors used in the installation of photovoltaic equipment. Easy to use: Simply insert the spanner pins into the securing clips of the two connectors, release and gently pull apart to separate the two connectors. Durable: Manufactured from reinforced plastic which is durable, light and easy to carry. Universal: Suitable for all common connectors used to extend photovoltaic lines of solar panels, photovoltaic connectors, photovoltaic solar cables, solar generators and solar line connectors.

Item No.		
T4348	1000V	340
T4348 2	1500V	400

Mainstesters



Mainstester - 120-250V AC

Insulated for protection. Neon light for high visibility. Pocket clip.

Item No.			
440005	65mm	3mm	3



VDE Mainstester - Pocket Clip

VDE approved mainstester for assured safety. Neon light for high visibility. Pocket clip.

DIN 57680 -6 VDE 680 -6 - Cert no 40011575

Item No.				
440007	65mm	3mm	0.5mm	12



VDE Mainstester - 125-250V AC

Premium quality VDE approved for assured safety. Neon light for high visibility. Finger slip guard for added safety. Integrated pocket clip.

DIN 57680 -6 VDE 680 -6 Cert No 109826

Item No.			
440008	150mm	3mm	12
440009	190mm	3.5mm	12



Long Mainstester - 120-250V AC

VDE approved mainstester for assured safety. Neon light for high visibility. Pocket clip.

DIN 57680 -6 VDE 680 -6 Cert No 40016094

Item No.				
440012	100mm	4mm	0.6mm	12



Heavy Duty Mainstester - 120-250V AC

Extended shaft for long reach applications. Insulated for protection. Neon light for high visibility.

Item No.				
440013	120mm	4mm	0.6mm	12

Voltage Detectors



Voltage Detector - Visual

Suitable for non-contact AC voltage tests, e.g. earthing/ground connection checks, proper connection checks, broken wire detection, etc. Bright red LED illumination on detection of AC voltage. Double insulated to ensure safe use near live circuitry. Ergonomic, dual component body construction with a handy pocket clip.

EMC BS EN 61326-1-2-3, BS EN 61000-3

Item No.



T2271A

6



Voltage Detector - Visual & Audible

Suitable for non-contact AC voltage tests, e.g. earthing/ground connection checks, proper connection checks, broken wire detection, etc. Bright red LED illumination & audible alarm on detection of AC voltage. Double insulated to ensure safe use near live circuitry. Ergonomic, dual component body construction with a handy pocket clip.

EMC BS EN 61326-1-2-3, BS EN 61000-4

Item No.



T2272A

6

Switch Keys



Universal Switch Key - 9 in 1

Cross key design with swivel ends offering 9 different key types. Heavy duty cast alloy construction for strength. PH2 screwdriver bit included.

Item No.



T4451-2

50



Universal Switch & Cabinet Key

Multi-purpose tool for locking systems of electric, gas and water enclosures and other technical installations in buildings such as air conditioning and ventilation systems, shut-off valves, mains consoles etc. Heavy duty cast alloy construction for strength. 6mm bit driver adaptor & double ended screwdriver bit included (PH2 / Slotted 1.0 x 7 mm). Fittings: 1/4" hexagon for bits, Square 5mm, 6 - 7mm, 7 - 8mm, Three-Square 9mm, Tapered-Square 4 - 10mm.

Item No.



495015

1



Cabinet Wrench Key - 8 in 1

Greater ergonomics, comfort and accessibility for users, without sacrificing versatility. Suitable for electrical, gas and water cabinet closures, it offers users the versatility of two 360° rotating key heads, incorporating double functionality. The double-joint design improves ergonomics over standard keys, allowing users to transform the key into a T handle for high-torque applications. With a compact profile manufactured from durable glass reinforced polymer, users will welcome the additional comfort, when in use or when carried in a pocket.

Item No.



T4456

75



Cabinet Cross Key - 12 in 1

Features key heads with double function for convenience and versatility. Durable die-cast Zinc construction for industrial applications. Includes screwdriver bit adaptor and double ended bit. Suitable for all current electrical, gas and water cabinet closures.

Item No.



T4455

100

Hexagon Keys



Insulated T Handle Hex Keys

VDE approved - individually tested to 10,000V for safe working up to 1,000V. Premium quality S2 steel blade, tempered and hardened for exceptional strength & durability. Dual component, ergonomic handle for comfort and control. IEC60900 VDE 0682-201

Item No.		
T4422 03	3mm	6
T4422 035	3.5mm	6
T4422 04	4mm	6



Insulated T Handle Hex Key Set

VDE approved - individually tested to 10,000V for safe working up to 1,000V. Premium quality S2 steel blade, tempered and hardened for exceptional strength & durability. Dual component, ergonomic handle for comfort and control. IEC60900 VDE 0682-201

Item No.		
T4422 SET	3, 3.5, 4, 5 & 6mm	20

Re-Threading Tools

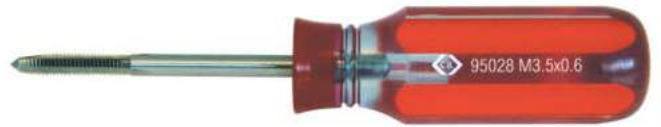

Re-Threading Tools

Tough, impact resistant handle. High speed steel tap for a clean cut and long life. Precision ground threads for accurate threading. 50mm long blade for improved access.

Item No.				
495028	M3.5	0.6mm	113mm	12
495029	M4	0.7mm	113mm	12

Soldering



Soldering Irons

High quality, heavy duty construction for professional use. Long life tips suitable for use with lead free solder. Individually tested to 10,000V for safe live working up to 1,000V. EMC, LDV, ROHS, WEEE

Item No.		
495009	Soldering iron 25W - UK 3 pin plug	1
495010	Soldering iron 40W - UK 3 pin plug	1
495011	Soldering iron 25W - Euro 2 pin plug	1
495012	Soldering iron 40W - Euro 2 pin plug	1
495013	Spare tip set for 25W	1
495014	Spare tip set for 40W	1



Soldering Wire

Lead free special alloy. 2.5% flux incorporated. Solder wire: ISO-core Sn99CU1. EN 61190/DIN29545-1 DIN29453

Item No.			
T6052 51	500g	1mm	20
T6052 52	500g	2mm	20



Toolkits

Toolkits

68

Tool Storage

71

Toolkits



Professional Tool Kit

A complete electrician's tool kit featuring Combicutter3 side cutters and Dextro screwdrivers, all contained in the award winning C.K technicians toolcase. CONTENTS: Technician's toolcase. Redline VDE side cutters 165mm. Combination pliers 160mm; Combination pliers 185mm; Snipe nose pliers 175mm; 7 x Dextro VDE screwdrivers, slotted, sizes: 2.5 x 75 & 4 x 100mm; Pozidriv, sizes: PZ1 x 80 & PZ2 x 100mm; Phillips, sizes: PH1 x 80 & PH2 x 100mm; Modulo, size: 2; VDE mainstester; Tape 5m/16ft; Junior hacksaw; Electrician's knife; Automatic wire stripper PRO; Pocket level; Re-threading tool M3.5; Claw hammer.

Item No.



T5982

1



Electrician's Tool Kit - European

A complete electrician's tool kit featuring Dextro screwdrivers, all contained in the award winning C.K technicians toolcase. CONTENTS: Technician's toolcase. Redline VDE side cutters 165mm. Combination pliers 175mm. Snipe nose pliers 175mm. 7 x Dextro VDE screwdrivers, slotted, sizes: 2.5 x 75 & 4 x 100mm; Pozidriv, sizes: PZ1 x 80 & PZ2 x 100mm; Phillips, sizes: PH1 x 80 & PH2 x 100mm; Modulo, sizes: 1 & VDE mainstester. ST Tape 8m. Mini hacksaw. Electrician's knife. Automatic wire strippers. Cable knife. Plasterboard saw.

Item Number



T1630 FKIT

1



Professional Plus Tool Kit

Our most comprehensive kit yet, the new C.K Professional Plus Tool Kit is built for greater productivity and efficiency. Includes innovations such as the Combicutter3, the ArmourSlice SWA Cable Stripper and DextroVDE slim glo screwdrivers. All contained within the C.K Magma Pro Tool Case Plus, the ultimate bag to organise and protect your tools. CONTENTS: Technicians Pro Tool Case, RedLine VDE Combination Pliers 185mm, RedLine VDE Snipe Nose Pliers 175mm, RedLine VDE CombiCutter3 160mm, DextroVDE GLO Slim Screwdriver Set/5 PZ/SL, Conduit Bush Wrench, ArmourSlice SWA Cable Stripper, VDE Precision Screwdriver Set/7, VDE Cable Knife, Japanese Prybar, Electricians Scissors, Softech Tape 5m/16ft, Automatic Wire Stripper PRO, Coax Cable Stripper, Pocket Spirit Level 210mm, LED Pocket Inspection Light, Re-threading tool M3.5x0.6.

Item No.



T5983

1



EV Charging Point Tool Kit

The COMPLETE toolkit for EV Charger Installation. Built for greater efficiency and productivity. Configured using industry expertise and best practices. Technicians Wheeled Case for versatile storage and mobility. CONTENTS: Technicians Wheeled Case, SpiraFLEX Draw Tape 10m, ArmourSlice SWA Cable Stripper, Conduit Bush Wrench, Voltage Detector, Waterpump Pliers 250mm, RedLine VDE Side Cutter 160mm, RedLine VDE Electricians Plier 180mm, RedLine VDE Heavy Duty Cable Cutter 210mm, AT Tape Measure 5m / 16ft, Pocket Level, Junior Hacksaw, Hacksaw Blades, VDE Cable Sheath Stripping Knife, Folding Utility Knife, Sealant Gun, Automatic Wire Stripper Pro, Claw Hammer, VDE Torque Screwdriver, Insulated T Handle Hex Key Set, VDE Interchangeable Slim Blade Set, Socket & Spanner Set, 6 - 25mm Ratchet Crimping Pliers, 0.25 - 6.0mm Ratchet Crimping Pliers, 1.5 - 10mm Ratchet Crimping Pliers, Compact Crimper.

Item No.



T5984

1



EV Charging Point PTA Kit

A complete set of power tool accessories to support the EV tool kit. From drilling through walls to fixing clips, the PTA Kit covers all the bases for a standard EV installation. CONTENTS: T3121 C.K Concrete Drill Bit Set of 7, AV08014 Mansonry 1m SDS Drill Bit Set - 3 piece set, T3063 C.K Multi Purpose Drill Set Of 5, T2942P C.K Flat Wood Bit Set/6, T3202 020 C.K Sheet Steel Hole Saw 20mm, T3202 025 C.K Sheet Steel Hole Saw 25mm, T3202 032 C.K Sheet Steel Hole Saw 32mm, T4510 C.K Blue Steel Impact Screwdriver Bit - PZ Set of 10.

Item No.	
T5985	1



Solar Installer Tool Kit

A carefully crafted kit including all the tools needed for the installation and maintenance of Solar PV equipment in domestic and commercial applications. Suitable for a variety of solar systems and designed for greater efficiency and confidence on the job. CONTENTS: C.K Magma Rucksack Plus, Ratchet Crimping Plier Solar PV, Cable Cutter 210mm, Jokari SE-Strip Wire Stripper 2.5mm-6mm, Coloured SureDrive 3/8in Socket & Spanner Set, MC4 Solar Connection Spanner 1000V, MC4 Solar Connection Spanner 1500V, Dextro VDE Screwdriver SLP 4X100, Dextro VDE Screwdriver PZ2x100, Magnetic Nut Drivers Set/7pc, XT Tape Measure 7.5M 25FT, Hexagon Key Metric Folding Set/8pc.

Item No.	
T5988	4



Electricians Apprentice Kit

The ultimate apprentice kit including all the tools needed for installation, commissioning, testing and maintenance across domestic and commercial electrical work. Configured using the latest Electrical Training Phase Two syllabus, each tool has been hand-picked to get the job done with confidence and efficiency. CONTENTS: MA2635 C.K Magma Rucksack Plus, 431003 RedLine VDE Combination Pliers, 431008 RedLine VDE CombiCutter3, 431014 RedLine VDE Snipe Nose Pliers, T3943 Automatic Wire Stripper Pro, T3653 250 Push Button Waterpump Pliers, T4366 200 Adjustable Wrench 200mm, T0905 C.K Hacksaw, T0834 C.K Junior Hacksaw, T0832 C.K Sabretooth Plasterboard Saw, T4755 Conduit Bush Wrench, 484001 Electricians Knife, T49193D Dextro VDE Screwdriver Set, T3482 Pocket Level 210mm/8 1/4in, T3494 16 Level-Box Section, T3442 25 ST Tape 7.5/25ft, T0083 6 C.K Engineers File Round, T4443M Ball-ended Long-arm Hexagon Set, T1280 Cable Stripper, T2272A Non Contact Voltage Detector, T4229 16 Steel Claw Hammer 16oz.

Item No.	
T5987	1



Complete Tool Kit

Professional quality tools for everyday tasks - A carefully crafted tool kit with a selection of tools to tackle multiple tasks for building and plumbing. Spacious and robust tool tote to expand the kit with other tools from the C.K range. CONTENTS: MA2636 C.K Magma 18inch Open Tool Tote, T0954 C.K Folding Utility Knife, T3442 16 ST Tape 5m/16ft, T3621B 7 Classic Combination Pliers, T3623B 6 Classic Side Cutter 160mm, T4366 200 Adjustable Wrench 200mm, T4727 Triton Xls Screwdrivers, T0834 C.K Junior Hacksaw, T3494 16 Level-Box Section, F3659A 240 Waterpump Plier 240mm, T4229 16 Steel Claw Hammer 16oz.

Item No.	
T5971	1



Contractor Tool Kit

A flexible selection of tools for general maintenance and repair contained within the C.K Magma technician's tote. CONTENTS: C.K Magma Technician's Tote, VDE Side Cutter 160mm, VDE Combination Pliers 185mm, VDE Snipe Nose Pliers 175mm, VDE Screwdrivers, PZD 1 & 2, VDE Screwdrivers, Slotted 2.5 x 75; 4.0 x 100mm, Waterpump Pliers 250mm, Tape 5 Meter / 16 ft, Mini Hacksaw, Pocket Spirit Level, Universal Cable Stripper.

Item No.	
T5981	1



Core Tool Kit

Professional Quality Tools for Everyday Tasks - A carefully crafted tool kit with a basic selection of tools to tackle common tasks either around the home or on site. Can be used as part of a larger tool kit and as a compact grab and go bag for smaller jobs. CONTENTS: MA2718 C.K Magma Tool Roll, T0954 C.K Folding Utility Knife, T3442 16 ST Tape 5m/16ft, T3621B 7 Classic Combination Pliers, T3623B 6 Classic Side Cutter 160mm, T4522 Bit Clip Phillips/PZD/SDV, T4521 Bit Clip Slotted 8 Piece, T4516 Triton Xls Screwdriver Bit Holder, T0834 C.K Junior Hacksaw.

Item No.	
T5970	1



Essential Tool Kit

Entry level tool kit containing the bare essentials. CONTENTS: C.K Magma Essential Tool Pouch, VDE CombiCutter 3 160mm, VDE Combination Pliers 185mm, VDE Screwdriver, PZ2, VDE Screwdrivers, Slotted 2.5 x 75 & 4.0 x 100mm.

Item No.	
T5980	1



VDE Pliers & Screwdrivers Kit - PZ

Collection of VDE pliers, cutters & screwdrivers stored within a zipper wallet. CONTENTS: Zip Case, VDE Side Cutter 160mm, VDE Combination Pliers 185mm, VDE Snipe Nose Pliers 175mm, VDE Screwdrivers, PZD 1 & 2, VDE Screwdrivers, Slotted 2.5 x 75; 4.0 x 100 & 5.5 x 125mm, Voltage detector, visual indicator 70-1000V, CAT IV.

BS EN 60900 , VDE 682/201, ASTM-F 1505

Item Number	
T5953	1



VDE Pliers & Screwdrivers Kit - PH

Collection of VDE pliers, cutters & screwdrivers stored within a zipper wallet. CONTENTS: Zip Case, VDE Side Cutter 160mm, VDE Combination Pliers 185mm, VDE Snipe Nose Pliers 175mm, VDE Screwdrivers, PH 1 & 2, VDE Screwdrivers, Slotted 2.5 x 75; 4.0 x 100 & 5.5 x 125mm, Voltage detector, visual indicator 70-1000V, CAT IV.

BS EN 60900 , VDE 682/201, ASTM-F 1505

Item Number	
T5954	1



Technicians Tool Kit

Collection of essential tools for the mobile technician. CONTENTS: Zip Case, Precision Wire Stripper 0.25 - 0.80mm, Inspection mirror, telescopic 38mm, ESD Side Cutter 125mm, ESD Snipe Nose Pliers 130mm, 7 ESD Electronic Screwdrivers: Phillips 0x60 and 1x80mm. Slotted 2.5x75 ; 3.0x100 ; 3.0x150 ; 4.0x100 and 4.0x150mm, Precision Tweezers, ESD Bit Driver, Bit set with the following CONTENTS: magnetic bit holder; 8 Bits Slotted sizes 3, 4, 4.5, 5, 5.5, 6, 7, 8; 4 Bits PZD sizes 0, 1, 2, 3; 4 Bits Phillips sizes 0, 1, 2, 3; 8 Bits TX sizes 8, 10, 15, 20, 25, 27, 30, 40; 8 Bits Hexagon sizes 1.5, 2, 2.5, 3, 4, 5, 5.5, 6.

Item Number	
T5956	1



Electricians Service Case

Professional ABS tool case with aluminium frame. 2 high quality press button locks, lockable, additional 3-digit combination lock. Bottom tray 59mm high, with variable dividers. Bottom tray lid, flush fitting, 14 compartments. Tool board double sided, 32 tool compartments and elastic band for 12 parts, detachable. 1 fixed Din A4 document compartment with additional compartments. CONTENTS: T20050 Jokari Auto Stripper, T3773EF Classic Side Cutter, F431013 RedLine VDE Snipe Nose Pliers, T3650 250 Waterpump Plier 250mm, F431015 RedLine VDE Bent Snipe Nose Pliers, F431002 RedLine VDE Combi Pliers 180mm, F431004 RedLine VDE Combicutter1 160mm, T4406 Hexagon Key, 440007 Mainstester VDE 120-250V, T49144-030 Dextro VDE Screwdriver, T49144-040 Dextro VDE Screwdriver, T49144-055 Dextro VDE Screwdriver, T49144-065 Dextro VDE Screwdriver, T49143-1 Dextro VDE Screwdriver, T49143-2 Dextro VDE Screwdriver, T49142-1 Dextro VDE Screwdriver, AV06040 Multi-Purpose Snips, T49142-2 Dextro VDE Screwdriver, F84001 Electricians Knife, T10280 Jokari Cable Knife, T0836A C.K Mini Hacksaw, T1643 Rigid Service Case, 356001 French Pattern Electricians Hammer, T4455 Cabinet Cross-Key 12 in 1, T3442M 8 ST Tape 8M, T4880X 256 Xonic Screwdriver.

Item No.



T1641

1



Electronic Service Case

Professional ABS tool case with aluminium frame. 2 high quality press button locks, lockable, additional 3-digit combination lock. Bottom tray 59mm high, with variable dividers. Bottom tray lid, flush fitting, 14 compartments. Tool board double sided, 32 tool compartments and elastic band for 12 parts, detachable. 1 fixed Din A4 document compartment with additional compartments for CD. T20050 Jokari Auto Stripper, T3773EF Classic Side Cutter, T3777 Classic Snipe Nose Plier, T2328 Radio Tweezers Bent 61/4in, F431004 RedLine VDE Combicutter1 160mm, F431002 RedLine VDE Combi Pliers 180mm, F431014 RedLine VDE Snipe Nose Pliers, 440007 Mainstester VDE 120-250V, T5913 32 Inspection Mirror 32mm, T4334M 055 HD Classic Nut Spinner, T4334M 07 HD Classic Nut Spinner, T4334M 08 HD Classic Nut Spinner, T4334M 10 HD Classic Nut Spinner, T49144-030 Dextro VDE Screwdriver, T49144-040 Dextro VDE Screwdriver, T49144-055 Dextro VDE Screwdriver, T49144-065 Dextro VDE Screwdriver, T49143-0 Dextro VDE Screwdriver, T49143-1 Dextro VDE Screwdriver, T49142-0 Dextro VDE Screwdriver, T49142-2 Dextro VDE Screwdriver, 484001 Electricians Knife, AV06040 Multi-Purpose Snips, 492001 Electricians Scissors 140mm, T10280 Jokari Cable Knife, T1643 Rigid Service Case, T4455 Cabinet Cross-Key 12 in 1, 330013 Wire Stripper Adjustable, T4406 Hexagon Key, T4880XES256 Xonic ESD Screwdriver.

Item No.



T1642

1

Tool Storage



Tool Wallet

Tough fabric zip up carry case with elasticated internal loops. 340mm x 245mm with expansion of up to 65mm to accommodate tools.

Item Number



316001

1



Rigid Service Case

Tough ABS plastic service case with aluminium frame for the safe transportation of tools and equipment. CONTENTS: over 40 pockets and straps, 14 adjustable compartments and a fixed document compartment making this case ideal for a wide range of service engineer trades.

Item No.



T1643

1

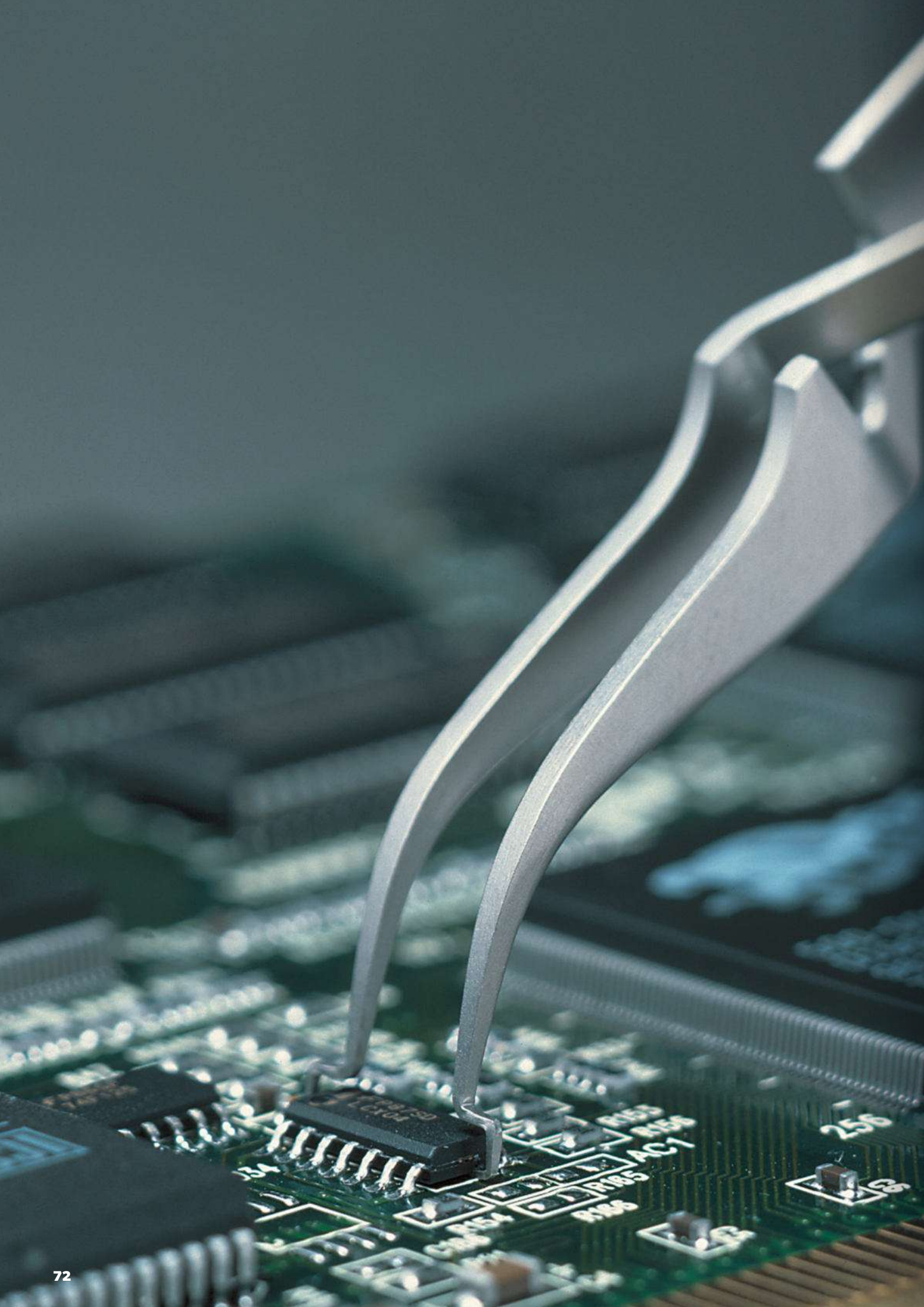

ESD & Precision

SensoPlus ESD Pliers & Cutters	76
Precision Pliers & Cutters	80
Ecotronic ESD	84
ESD Wire Stripping Pliers	86
Carbofib ESD	87
Precision Tweezers	88
Precision ESD Tweezers	92
Triton ESD	94
Xonic ESD	96
Xonic Precision Screwdrivers	98
Precision Screwdrivers	100
Precision Ceramic Trimmers	100
Plastic Trimmers	101
Precision Wire Strippers	102
Other	103

The C.K ESD and Precision range is designed for professionals who need hand tools for ultra fine work, where use of intricate components or tight access are issues, for example in the electronics and fine mechanics industries.

The international standard IEC 61340-5-1 for protection of electronic devices from electrostatic phenomena prohibits the use of non-ESD (electrostatic dissipative) products in Electrostatic Protected Areas (EPAs). C.K offers a wide variety of hand tools in compliance with these standards.



What is ESD?

ESD stands for Electro Static Discharge.

ESD can cause unseen damage to electronic components during manufacture of electronic assemblies and equipment. If the damaged component fails immediately, the result can be a board that fails quality control tests and requires rework. This represents lost production and additional manufacturing costs.

Worse than this, a component may be partially damaged and weakened. It may suffer a change or drift in characteristics. It may remain within specification, but fail later when in use by a customer. It has been estimated that 90% of damages to devices may be incurred in this way.

In manual assembly most ESD arises from charged personnel, if they are not grounded.

One of the main principles used to protect ESD sensitive components from ESD damage is to only handle sensitive components in an ESD Protected Area (EPA) under protected and controlled conditions. An EPA is an area in which static electricity is kept below levels that could cause damage to electronic components handled within the area.



Precision box joint

The box joint construction of our pliers and cutters is a specialised technique which physically slots one half of the plier through the other. Although more difficult to manufacture, the doubly supported pivot gives smooth and accurate action, longer product life, and removes the requirement for readjustment.



Hot drop forged blanks

Hot drop forging gives maximum strength to our tools through optimising the grain structure.



Spot welded double leaf springs

Spot welded springs mean that no replacements or adjustments are necessary. The action of each pair of pliers will be consistent and controlled with no maintenance costs.



Cutting Edges

The geometry of the cutting blade affects both the cutting action and performance, and the lifetime of the product. The sharper the angle, the fewer cutting forces are generated. Reduced cutting forces not only lead to a smoother and easier feeling cut, but also limits potentially damaging pressure or 'cutting shock' to sensitive components. There is a trade-off however. The blade will wear more quickly and the cutting capacity will be lower.



Mini Bevel

- Standard cut.
- Highest cutting capacity.
- Robust and long lasting.

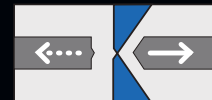

Full Flush

- Almost full flush cutting.
- Cutting shock slightly reduced.



Extra Full Flush

- Perfectly flush cutting.
- Suitable for non-shock cutting.

Key

	Mini Bevel cut
	Full Flush cut
	Extra Full Flush cut
	Smooth jaws
	Serrated jaws
CF	Carbon-fibre tips and SA-steel
SA	Stainless steel (No. 4435 / AISI 316)
S	Stainless steel
C	Carbon steel, hardened
SA ESD	Stainless steel, ESD-safe black, epoxy coating
	Piano Ømm AWG
	Hard Ømm AWG
	Medium/Hard Ømm AWG
	Soft Ømm AWG



Mirror polished surface

The micro-fine steel surface provides an attractive finish with no risk of flaking chrome plating which could damage circuits and components.



Careful choice of raw materials

We carefully select different high alloy carbon and chrome vanadium steels to match the varying demands of each product.

Dissipative precision pliers & cutters

1. Special alloy steel, drop forged, hardened and tempered for exceptional strength and durability.
2. Precision box joint construction for permanent, adjustment free jaw alignment.
3. Induction hardened jaws for outstanding long term performance.
4. Mirror polished surface eliminates the risk of damage from flaking chrome.
5. Spot welded double leaf springs for consistent, repetitive action.
6. Ergonomically designed dual component handles for increased comfort and control.
7. Fully ESD compliant for safe use on sensitive electronic components.

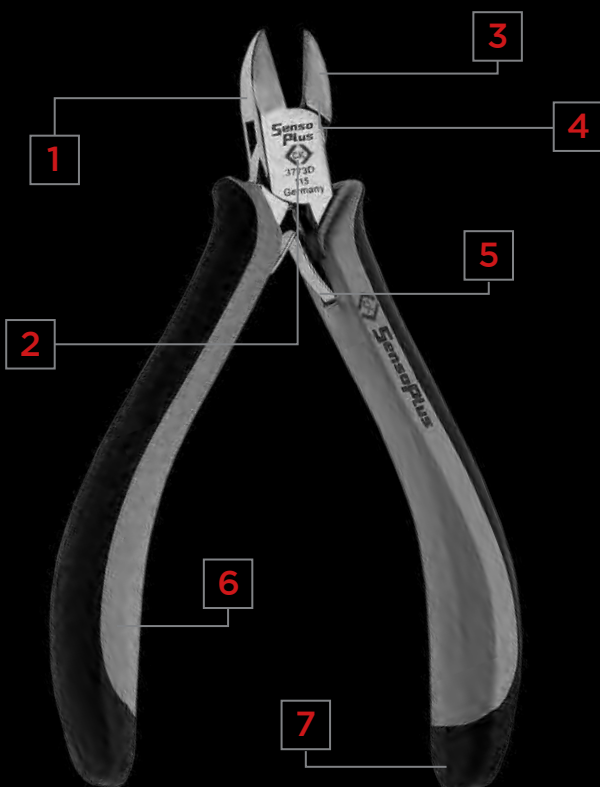

SensoPlus ESD Pliers & Cutters



ESD Side Cutter

Relieved jaws.

IEC 61340. 5.1 & 5.2

Item No.	Ø	Ø	●	↔	i	📦
T3766DF 110	1.5 / 15	0.8 / 20	-	120mm	📄	1
T3766DEF110	1.5 / 15	0.6 / 22	-	120mm	📄	1
T3766DEF 120	1.0 / 18	0.6 / 22	-	125mm	📄	1

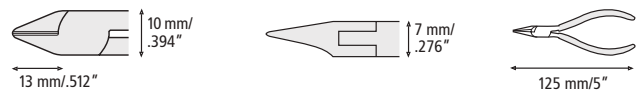

ESD Side Cutter

IEC 61340. 5.1 & 5.2

Item No.	Ø	Ø	●	↔	i	📦
T3773D 115	1.5 / 15	1.0 / 18	0.4 / 26	125mm	📄	1
T3773DF 115	1.5 / 15	1.0 / 18	-	125mm	📄	1
T3773DEF115	1.5 / 15	0.8 / 20	-	125mm	📄	1

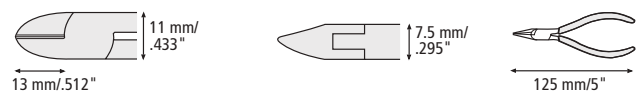

ESD Tungsten Carbide Side Cutter

Tungsten carbide edges, relieved jaws.

IEC 61340. 5.1 & 5.2

Item No.	Ø	●	○	↔	i	📦
T3787DF 115	1.8 / 13	1.0 / 18	0.4 / 22	125mm	📄	1



ESD Side Cutter

IEC 61340. 5.1 & 5.2

Item No.						
T3780DF 110	1.5 / 15	0.8 / 20	-	120mm		1
T3780DEF 110	1.0 / 18	0.6 / 22	-	120mm		1

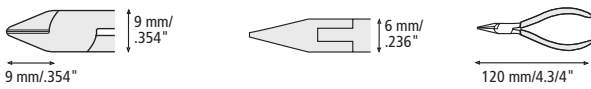

ESD Side Cutter

Tungsten carbide edges.

IEC 61340. 5.1 & 5.2

Item No.					WC	
T3779D 115	2.0 / 12	1.0 / 18	0.6 / 22	120mm		1

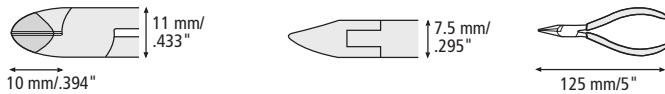

ESD Side Cutter

IEC 61340. 5.1 & 5.2

Item No.						
T3775D	2.0 / 12	1.5 / 15	0.7 / 21	140mm		1



ESD Bevel Side Cutter

IEC 61340. 5.1 & 5.2

Item No.						
T3781D 115	1.5 / 15	1.0 / 18	0. / 28	125mm		1
T3781DF 115	1.5 / 15	1.0 / 18	-	125mm		1
T3781DEF 115	1.5 / 15	0.8 / 20	-	125mm		1

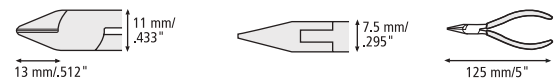

ESD Bevel Wire Catch Side Cutter

Wire catch facility to prevent waste material causing damage to sensitive equipment.

IEC 61340. 5.1 & 5.2

Item No.						
T3782D 115	1.5 / 15	1.0 / 18	0.4 / 26	125mm		1
T3782DEF 115	1.5 / 15	0.8 / 20	-	125mm		1

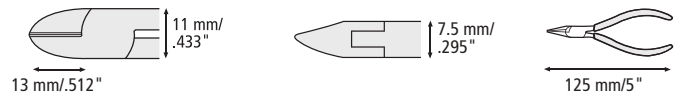

ESD Oval Head Cutter

Tapered head.

IEC 61340. 5.1 & 5.2

Item No.						
T3880DF 110	1.5 / 15	1.0 / 18	0.4 / 26	120mm		1
T3880DEF 110	1.0 / 18	0.6 / 22	-	120mm		1

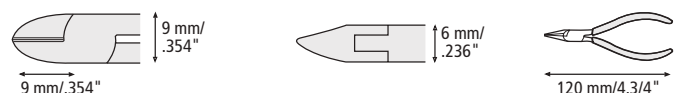



ESD Oblique Cutters

Tungsten carbide edges.
IEC 61340. 5.1 & 5.2

Item No.					WC	
T3760DF 110	2.0 / 12	1.0 / 18	0.6 / 22	120mm		1

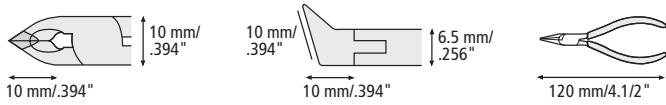

ESD Oblique Cutters

Straight head.
IEC 61340. 5.1 & 5.2

Item No.						
T3799DF 110	1.2 / 16	1.0 / 18	0.4 / 26	120mm		1
T3799DEF 110	1.0 / 18	0.8 / 20	-	120mm		1

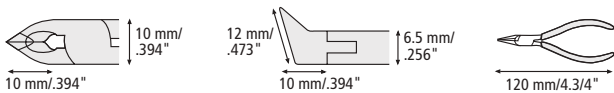

ESD Oblique Cutters

IEC 61340. 5.1 & 5.2

Item No.						
T3778DF	1.6 / 14	1.0 / 18	0.3 / 28	125mm		1



ESD Top Cutters

IEC 61340. 5.1 & 5.2

Item No.						
T3776DEF 115	2.0 / 12	1.6 / 14	-	120mm		1



ESD Oblique Tip Cutters

Very slim, pointed jaws.
IEC 61340. 5.1 & 5.2

Item No.						
T3871DF 120	0.8 / 20	0.6 / 22	-	130mm		1

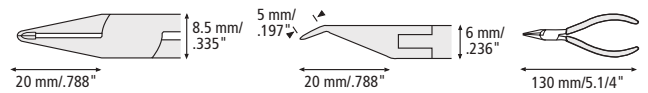

ESD Oblique Cutters

IEC 61340. 5.1 & 5.2

Item No:						
T3786DF 120	0.8 / 20	0.6 / 22	-	130mm		1

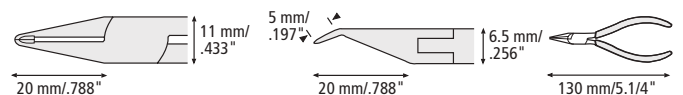



ESD Top Cutters

Laid-on joint.
IEC 61340. 5.1 & 5.2

Item No.						
T3784DF	0.8 / 20	0.6 / 22	-	130mm		1



ESD Snipe Nose Pliers

IEC 61340. 5.1 & 5.2

Item No.			
T3772D 120	130mm		1
T3772 1D120	130mm		1



ESD Snipe Nose Pliers

IEC 61340. 5.1 & 5.2

Item No.			
T3777D 150	155mm		1



ESD Bent Snipe Nose Pliers

Bent nose.
IEC 61340. 5.1 & 5.2

Item No.			
T3767D 120	130mm		1



ESD Bent Snipe Nose Pliers

Bent nose.
IEC 61340. 5.1 & 5.2

Item No.			
T3769D 150	155mm		1



ESD Flat Nosed Pliers

IEC 61340. 5.1 & 5.2

Item No.			
T3770D 120	130mm		1
T3770 1D120	130mm		1



ESD Needle Nose Pliers

IEC 61340. 5.1 & 5.2

Item No.	Length	Info	Quantity
T3783D	155mm		1

 2 mm / .079"	 1.2 mm / .047"	 11 mm / .433"	 7.5 mm / .295"	 155 mm / 6.14"
------------------	--------------------	-------------------	--------------------	--------------------



ESD Round Nosed Pliers

IEC 61340. 5.1 & 5.2

Item No.	Length	Info	Quantity
T3771D 120	130mm		1

 2 mm / .079"	 1 mm / .039"	 10 mm / .394"	 6 mm / .236"	 130 mm / 5.14"
------------------	------------------	-------------------	------------------	--------------------



ESD Pliers Set - 6 Piece

Set of 6 electronic pliers in zip case. CONTENTS: Side cutter T3773D with mini-bevel, Side cutter T3880DF with full flush cut, Side cutter T3766DF with full flush cut, Oblique cutter T3786DF with full flush cut, Snipe nose plier T3772D with smooth jaws, Flat nose plier T3770D with smooth jaws.

IEC 61340. 5.1 & 5.2

Item No.	Info	Quantity
T3703D	Set of 6	1

 9 mm / .354"	 6 mm / .236"	 120 mm / 4.34"
------------------	------------------	--------------------



ESD Tool Kit

Set of 14 electronic pliers and Xonic ESD screwdrivers in a hard case. CONTENTS: T3772D 120 Snipe nose pliers, T3773D 115 Side cutter, T2334 Positioning tweezer, T2343 Precision tweezer, T4880XESD Slotted screwdrivers: 1.5 x 60, 1.8 x 60, 2.5 x 60, 2.5 x 75, 3 x 100, 4 x 100, T4882XESD Phillips screwdrivers: PH000 x 60, PH00 x 60, PH0 x 60, PH1 x 80. IEC 61340. 5.1 & 5.2

Item No.	Info	Quantity
T3707DX	Set of 14	1

Precision Pliers & Cutters



Precision Side Cutters

Item No.	Tip 1	Tip 2	Tip 3	Info	Quantity
T3773	1.5 / 15	1.0 / 18	0.4 / 26		1
T3773F	1.5 / 15	1.0 / 18	-		1
T3773EF	1.5 / 15	0.8 / 20	-		1

 11 mm / .433"	 7.5 mm / .295"	 115 mm / 4.12"
-------------------	--------------------	--------------------



Precision Side Cutters

Tungsten carbide edges.

Item No.	Tip 1	Tip 2	Tip 3	WC	Quantity
T3779	2.0 / 12	1.0 / 18	0.6 / 22		1

 11 mm / .433"	 7.5 mm / .295"	 125 mm / 5"
-------------------	--------------------	-----------------

CLASSIC™

Precision pliers & cutters

1. Special alloy steel, drop forged, hardened and tempered for exceptional strength and durability.
2. Precision box joint construction for permanent, adjustment free jaw alignment.
3. Induction hardened jaws for outstanding long term performance.
4. Mirror polished surface eliminates the risk of damage from flaking chrome.
5. Spot welded double leaf springs for consistent, repetitive action.
6. PVC handles for comfort and grip.



Precision Side Cutters

Item No.					
T3775	2.0 / 12	1.5 / 15	0.7 / 21		1
T3775EF	2.0 / 12	1.3 / 18	-		1

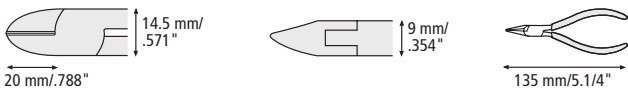

Precision Side Cutters

Laid-on joint.

Item No.					
T3774	1.5 / 15	1.0 / 18	0.4 / 26		1

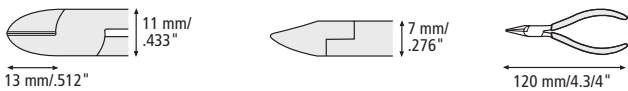

Precision Full Flush Side Cutters

Item No.					
T3780F	1.5 / 15	0.8 / 20	-		1
T3780EF	1.5 / 15	0.6 / 22	-		1

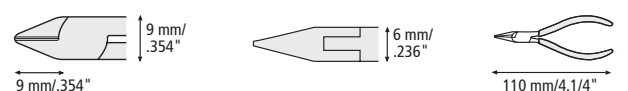



Precision Bevel Side Cutters

Item No.					
T3781	1.5 / 15	1.0 / 18	0.3 / 28		1

11 mm / .433"
 13 mm / .512"

7.5 mm / .295"

115 mm / 4.1/2"



Precision Oblique Cutters

Straight head.

Item No.					
T3799F	1.2 / 16	1.0 / 18	0.4 / 26		1

10 mm / .394"

12 mm / .473"
 10 mm / .394"

6.5 mm / .256"

110 mm / 4.1/4"



Precision Oval Head Cutters

Item No.					
T3880F	1.5 / 15	0.8 / 20	-		1

9 mm / .354"

6 mm / .236"

110 mm / 4.1/4"



Precision Oblique Tip Cutters

Item No.					
T3786F 4	0.8 / 20	0.6 / 22	-		1

11 mm / .433"
 20 mm / .788"

5 mm / .197"
 20 mm / .788"

6.5 mm / .256"

120 mm / 4.3/4"



Precision Oblique Cutters

Wide head, long blades.

Item No.					
T3778F	1.6 / 14	1.2 / 16	0.5 / 24		1

11 mm / .433"
 9 mm / .354"

18 mm / .709"
 7.5 mm / .295"

120 mm / 4.3/4"



Precision Top Cutters

Wide head, long blades.

Item No.					
T3776F	1.6 / 14	1.2 / 16	0.5 / 24		1

11 mm / .433"
 6 mm / .236"

15 mm / .590"
 7.5 mm / .295"

120 mm / 4.1/2"

Item No.					
T3776EF 5	2.0 / 12	1.6 / 14	-		1

14 mm / .550"
 9 mm / .354"

23 mm / .900"
 9 mm / .354"

130 mm / 5.1/4"



Precision Snipe Nose Pliers

Item No.	Length	Tip	Quantity
T3772	120mm		1
T3772.1	120mm		1



Precision Snipe Nose Pliers

Long nose.

Item No.	Length	Tip	Quantity
T3777	145mm		1



Precision Bent Snipe Nose Pliers

Bent nose.

Item No.	Length	Tip	Quantity
T3767	130mm		1



Precision Bent Snipe Nose Pliers

Bent nose.

Item No.	Length	Tip	Quantity
T3769	145mm		1



Precision Flat Nose Pliers

Item No.	Length	Tip	Quantity
T3770	120mm		1



Precision Flat Nose Pliers

Item No.	Length	Tip	Quantity
T3789	145mm		1



Precision Round Nose Pliers

Item No.			
T3771	120mm		1

	2 mm / .079"	10 mm / .394"		1 mm / .039"	6.5 mm / .250"	
37 mm / 1.459"		145 mm / 5.709"		120 mm / 4.724"		



Precision Needle Nose Pliers

Item No.			
T3783	145mm		1

	2 mm / .079"	11 mm / .433"		1.2 mm / .047"	7.5 mm / .295"	
37 mm / 1.459"		145 mm / 5.709"		145 mm / 5.709"		



Precision Wire Stripping Pliers

Laid-on joint.

Item No.		
T3796 5	0.1 - 0.8mm	1

	12 mm / .473"	32 mm / 1.26"		7 mm / .276"	
27 mm / 1.063"		140 mm / 5.512"		140 mm / 5.512"	



Precision Pliers Set - 6 Piece

Set of 6 electronic pliers in zip case. CONTENTS: Side cutter T3773 with mini bevel, Side cutter T3780F with full flush cut, Oblique cutter T3799F with full flush cut, Snipe nose plier T3772 with smooth jaws, Snipe nose plier T3767 with smooth jaws, Flat nose plier T3770 with smooth jaws.

Item No.		
T3703	Set of 6	1
T3703DL	Zip wallet	20

Ecotronic ESD



Ecotronic Micro Side Cutters

Micro, tapered cutting head. IEC 61340. 5.1 & 5.2

Item No.			
T3883	1.3 / 16		6

	16 mm / .630"		21°	4 mm / .157"	
9.5 mm / .374"	8 mm / .315"	132 mm / 5.197"		132 mm / 5.197"	



Ecotronic Reverse Side Cutters

Reverse action cutting blades. Cutting DIP pins on integrated circuits. IEC 61340. 5.1 & 5.2

Item No.			
T3884	1.3 / 16		6

	13 mm / .512"		48°	4 mm / .157"	
9.5 mm / .374"	8 mm / .315"	132 mm / 5.197"		132 mm / 5.197"	

Dissipative pliers & cutters

1. Fully ESD compliant for safe use on sensitive electronic components.
2. Strong and secure riveted joint.
3. Black oxidised finish to protect against corrosion.
4. Ergonomic dual component handles for increased comfort and control.



Ecotronic Slim Side Cutters

Slim, tapered cutting head.

IEC 61340. 5.1 & 5.2

Item No.			
T3885	1.3 / 16		6

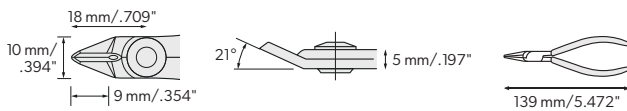

Ecotronic Relieved Side Cutters

Slim, tapered and relieved head.

IEC 61340. 5.1 & 5.2

Item No.			
T3886	1.3 / 16		6

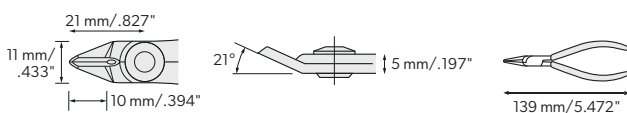

Ecotronic Side Cutters

IEC 61340. 5.1 & 5.2

Item No.			
T3887	1.6 / 14		6

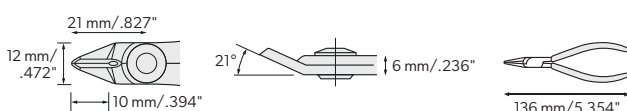



Ecotronic Side Cutters

Tapered and relieved head.
IEC 61340. 5.1 & 5.2

Item No.			
T3888	1.6 / 14		6



Ecotronic Flat Nose Pliers

IEC 61340. 5.1 & 5.2

Item No.			
T3891			6



Ecotronic Long Snipe Nose Pliers

IEC 61340. 5.1 & 5.2

Item No.			
T3889			6



Ecotronic Bent Snipe Nose Pliers

Bent tips.
IEC 61340. 5.1 & 5.2

Item No.			
T3892			6



Ecotronic Short Snipe Nose Pliers

IEC 61340. 5.1 & 5.2

Item No.			
T3890			6

ESD Wire Stripping Pliers



ESD Wire Stripping Pliers

Six pre-set blade pairs: 0.2, 0.3, 0.4, 0.5, 0.6, 0.8mm.
IEC 61340. 5.1 & 5.2

Item No.				
T3893	3 / 8	0.2 - 0.8mm	168mm	6



ESD Wire Stripper Pliers

Six pre-set blade pairs: 0.4, 0.5, 0.6, 0.8, 1.0, 1.3mm.
IEC 61340. 5.1 & 5.2

Item No.				
T3894	3 / 8	0.4 - 1.3mm	152mm	6

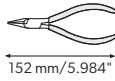
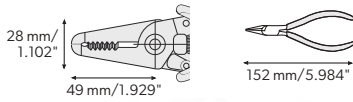

ESD Wire Stripping Pliers

Six pre-set blade pairs: 0.8, 1.0, 1.3, 1.6, 2.0, 2.6mm.
IEC 61340. 5.1 & 5.2

Item No.				
T3895	3 / 8	0.8 - 2.6mm	152mm	6

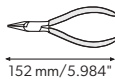
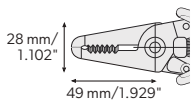

Carbofib ESD



Carbofib ESD Fine Tweezers

Fine tips.
IEC 61340. 5.1 & 5.2

Item No.		TYPE	
T2390	130mm	259CF	1



Carbofib ESD Slim Tweezers

Fine, extra slim tips.
IEC 61340. 5.1 & 5.2

Item No.		TYPE	
T2391	130mm	5CF	1



Carbofib ESD Round Tweezers

Round tips, 2mm wide.
IEC 61340. 5.1 & 5.2

Item No.		TYPE	
T2392	130mm	249CF	1



Dissipative Tweezers

1. Carbon fibre tips allow for safe handling of highly sensitive electrical components.
2. High grade, stainless steel bow - acid and corrosion resistant.
3. Precision welded joint for consistent, repetitive action.
4. Fully ESD compliant for safe use on sensitive electronic components.
5. Anti-magnetic to prevent electro-magnetic damage.
6. Heat resistant up to 270°C for safe use.

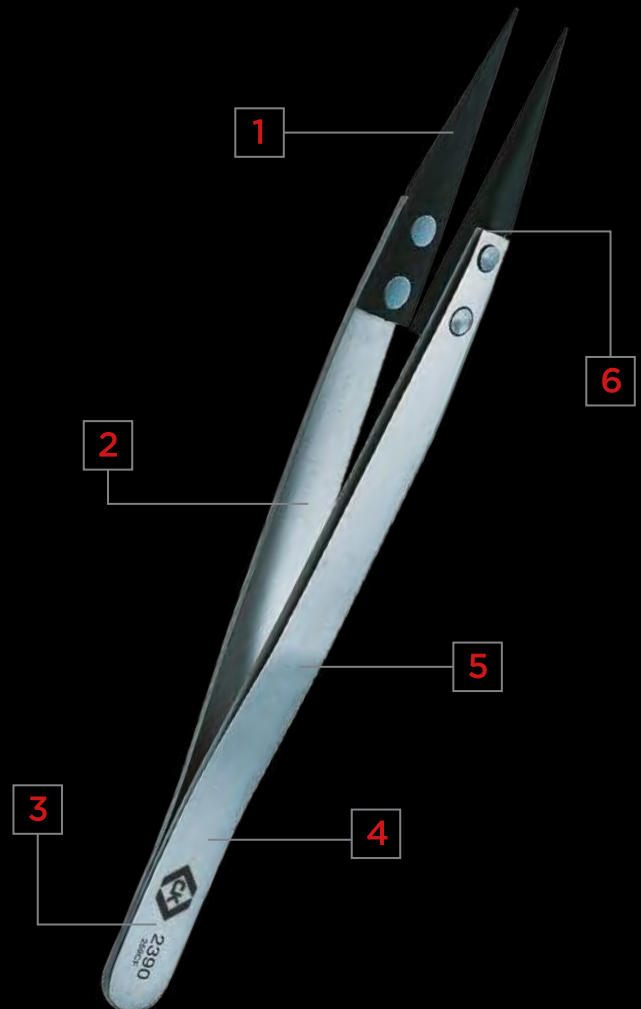

Tweezers

1. Manufactured using high grade, stainless steel - acid and corrosion resistant.
2. Anti-magnetic to prevent electro-magnetic damage.
3. Precision welded joint for consistent, repetitive action.
4. Fine polished for a non-reflective matt finish.

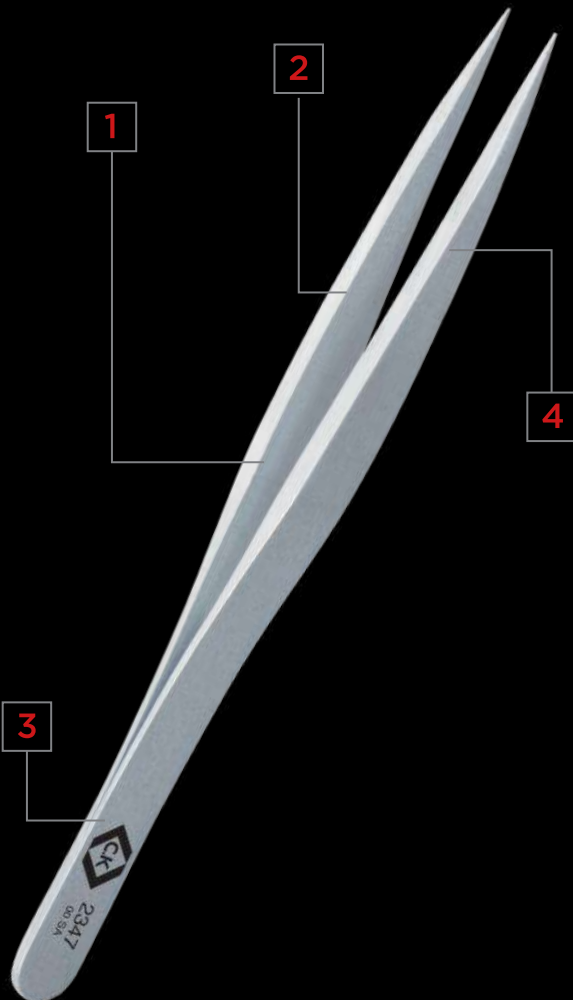

Precision Tweezers



Fine Universal Tweezers

Fine, blunt tips, 2mm wide, finely milled inside. Polished and fine nickel plated.

Item No.	←→	i	i	📦
T2301	115mm	C		1



Black Fine Universal Tweezers

Fine, blunt tips, 2mm wide, finely milled inside. Polished and black coated.

Item No.	←→	i	i	📦
T2302	115mm	C		1



Blunt Universal Tweezers

Blunt tips, 3.5mm wide, finely milled inside. Polished and fine nickel plated.

Item No.	←→	i	i	📦
T2307	145mm	C		1



Universal Tweezers

Blunt tips, 3.5mm wide, finely milled inside. Polished and black or PVC coated.

Item No.	←→	i	i	📦
T2308	145mm	Black	C	1
T2308A	145mm	PVC	C	1



Universal Cross-Cut Tweezers

Blunt tips, 2mm wide, fine cross cut inside. Polished and fine nickel plated.

Item No.			
T2309	140mm	C	1



Cross Pattern Tweezers

Reverse action. Soldering tweezers with finger pads to protect against heat. Fine, bent tips, 2.5mm wide. Polished and fine nickel plated.

Item No.			
T2313A	160mm	C	1



Tweezers - Guide Pin

Fine, blunt tips, bent, finely milled inside. With guide pin. Polished and fine nickel plated.

Item No.			
T2314	150mm	C	1



Black Tweezers - Guide Pin

Fine, blunt tips, bent, finely milled inside. With guide pin. Polished and black coated.

Item No.			
T2315	150mm	C	1



Fine Straight Tweezers

Fine, straight tips.

Item No.			
T2316	105mm	SA (18/10)	1



Bent Tweezers

Fine, bent tips.

Item No.			
T2317	105mm	SA (18/10)	1



Long Straight Tweezers

Fine, straight extra long tips.

Item No.			
T2318	130mm	SA (18/10)	1



Extra Long Tip Tweezers

Fine, straight extra long tips.

Item No.			
T2319	120mm	S	1



Radio Tweezers - Straight

Fine, blunt tips, 2mm wide, straight. Finely milled inside. Polished and fine nickel plated.

Item No.			
T2327	155mm	C	1



Radio Tweezers - Bent

Fine, blunt tips, 2mm wide, bent. Finely milled inside. Polished and fine nickel plated.

Item No.			
T2328	155mm	C	1



Curved Precision Tweezers

Fine tips, curved.

Item No.		TYPE	
T2339	110mm	7.SA	1



Angled Tweezers

Superfine tips, angled at 60°.

Item No.		TYPE	
T2330	110mm	5B.SA	1



Sharp Precision Tweezers

Fine, sharp tips, straight.

Item No.		TYPE	
T2340	110mm	3C.SA	1



Offset & Angled Tweezers

Superfine tips, offset and angled at 60°.

Item No.		TYPE	
T2331	115mm	5C.SA	1



Superfine Straight Tweezers

Superfine tips, straight.

Item No.		TYPE	
T2341	110mm	5B.SA	1



Positioning Tweezers

For SOT-packages, monolithic chip capacitors, etc.

Item No.		TYPE	
T2334	120mm	SM104.SA	1



Fine Straight Tweezers

Fine tips, straight.

Item No.		TYPE	
T2343	130mm	MM.SA	1



Angled Positioning Tweezers

Grooved tips, angled at 30°. For cylindrical devices up to 1mm Ø.

Item No.		TYPE	
T2336	120mm	SM115.SA	1



Ceramic Straight Tweezers

Fine, straight tips.

Item No.		TYPE	
T2345A	140mm	73 MZ SA	1



Straight Fine Tip Tweezers

Straight, fine tips.

Item No.		TYPE	
T2346	127mm	AA.SA	1



Round Positioning Tweezers

Tips round inside. For cylindrical devices up to 2mm Ø.

Item No.		TYPE	
T2354	115mm	578.SA	1



Strong Flat Precision Tweezers

Strong, thick, flat edges, straight.

Item No.		TYPE	
T2347	123mm	00.SA	1



Bent Positioning Tweezers

Fine, bent tips, fine cross-cut inside.

Item No.		TYPE	
T2359	150mm	22.SA	1



Flat Sharp Precision Tweezers

Flat, sharp, fine tips.

Item No.		TYPE	
T2348	122mm	2.SA	1



Round Positioning Tweezers

Flat, round tips, straight.

Item No.		TYPE	
T2360	120mm	2A.SA	1



Reverse Cross Pattern Tweezers

Reverse action. For SOT-packages, monolithic chip capacitors, etc.

Item No.		TYPE	
T2349	120mm	X104.SA	1



Flat Tip Tweezers

Spatulas. Square flat tips.

Item No.		TYPE	
T2364	105mm	127.SA	1



Round Positioning Tweezers

Tips round inside. For cylindrical devices up to 1mm Ø.

Item No.		TYPE	
T2351	115mm	582.SA	1



Flat Blunt Precision Tweezers

Flat, blunt tips, finely milled inside.

Item No.		TYPE	
T2381	120mm	OOD.SA	1

Tweezers

1. Manufactured using high grade, stainless steel - acid and corrosion resistant.
2. ESD-safe, black epoxy coating with a surface resistance of $10^5 - 10^6$.
3. Anti-magnetic to prevent electro-magnetic damage.
4. Precision welded joint for consistent, repetitive action.
5. Fine polished, matt finish on the tips.

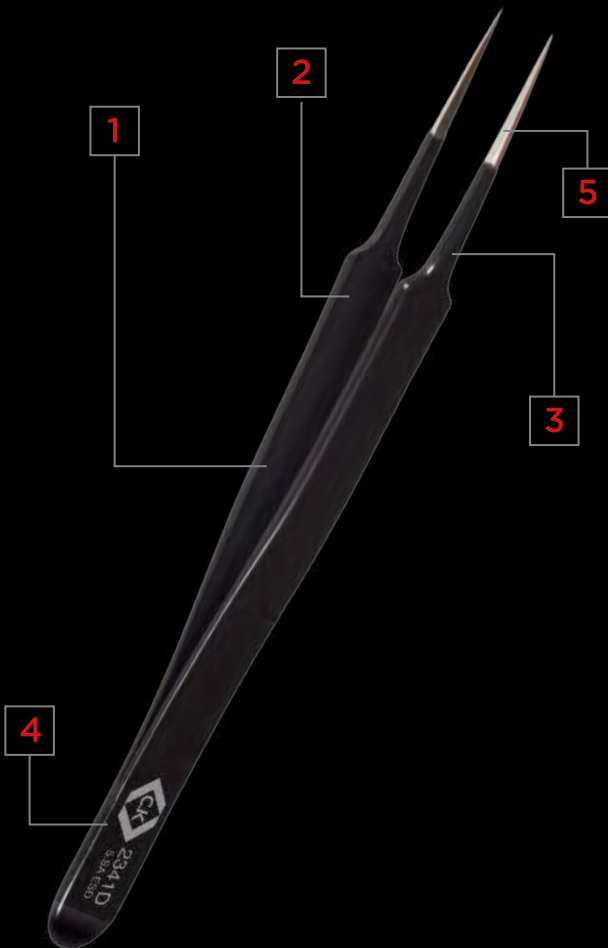

Precision ESD Tweezers



ESD Precision Tweezers

Extra fine, sharp, straight tips.
IEC 61340. 5.1 & 5.2

Item No.	←→	TYPE	📦
T2340D	110mm	3C.SA ESD	1



ESD Precision Tweezers

Superfine tips, straight.
IEC 61340. 5.1 & 5.2

Item No.	←→	TYPE	📦
T2341D	110mm	5.SA ESD	1



ESD Precision Tweezers

Straight, fine tips.
IEC 61340. 5.1 & 5.2

Item No.	←→	TYPE	📦
T2346D	127mm	AA.SA ESD	1



ESD Precision Tweezers

Strong, thick, flat edges, straight.
IEC 61340. 5.1 & 5.2

Item No.	←→	TYPE	📦
T2347D	122mm	00.SA ESD	1



ESD Precision Tweezers

Flat, sharp, fine tips.
IEC 61340. 5.1 & 5.2

Item No.	←→	TYPE	📦
T2348D	120mm	2.SA ESD	1



ESD Round Positioning Tweezers

Flat, fine, round tips. For handling delicate or small components.

IEC 61340. 5.1 & 5.2

Item No.		TYPE	
T2360D	123mm	2A.SA ESD	1



ESD Fine Precision Tweezers

Slim, straight, fine tips.

IEC 61340. 5.1 & 5.2

Item No.		TYPE	
T2369D	120mm	1.SA ESD	1



ESD Fine Curved Tweezers

Extra fine tips, curved and strong.

IEC 61340. 5.1 & 5.2

Item No.		TYPE	
T2361D	120mm	7A.SA ESD	1



ESD Curved Positioning Tweezers

Flat, fine tips, curved. For handling delicate or small components. Tip angle facilitates wafer tray loading.

IEC 61340. 5.1 & 5.2

Item No.		TYPE	
T2370D	117mm	2AB.SA ESD	1



ESD Smooth Tip Tweezers

For positioning and soldering 1mm wide components. 45° tips.

IEC 61340. 5.1 & 5.2

Item No.		TYPE	
T2362D	120mm	12.SA ESD	1



ESD Very Sharp Tweezers

Very sharp, fine tips.

IEC 61340. 5.1 & 5.2

Item No.		TYPE	
T2379D	120mm	3.SA ESD	1



ESD Positioning Tweezers

Grooved tips for positioning and soldering 1mm wide components.

IEC 61340. 5.1 & 5.2

Item No.		TYPE	
T2363D	120mm	13.SA ESD	1



ESD Extremely Fine Tweezers

Extra fine, straight tips.

IEC 61340. 5.1 & 5.2

Item No.		TYPE	
T2388D	110mm	4A.SA ESD	1



ESD Long Superfine Tweezers

Slim, long, superfine tips. Provides extended reach and access in confined areas.

IEC 61340. 5.1 & 5.2

Item No.		TYPE	
T2368D	140mm	SS.SA ESD	1



ESD Oblique Tweezers

Oblique, extra fine tips. For improved visibility whilst working.

IEC 61340. 5.1 & 5.2

Item No.		TYPE	
T2389D	120mm	5A.SA ESD	1

Dissipative screwdrivers

1. Ergonomic tri-lobe handle design for comfort and effective delivery of torque.
2. Fully ESD compliant for safe use on sensitive electronic components.
3. Toughened alloy steel blade for exceptional strength and durability.
4. Black anti-peel finish eliminates the risk of damage from flaking chrome.
5. Handle injection moulded directly to blade giving the ultimate bond for increased reliability and durability.
6. Precision machined tip for an exact screw fit and damage free screwdriving.



Triton ESD



ESD Screwdrivers - Slotted Parallel

DIN ISO 2380 , IEC 61340. 5.1 & 5.2

Item No.	Tip	Shaft Length	Tip Width	Tip Height	Weight
T4725ESD 03	3mm (1/8")	75mm (3")	0.5mm (0.02")	70mm (2 3/4")	6
T4725ESD 04	3mm (1/8")	100mm (4")	0.5mm (0.02")	80mm (3 1/8")	6
T4725ESD 41	4mm (5/32")	100mm (4")	0.8mm (0.031")	90mm (3 1/2")	6
T4725ESD 05	5mm (3/16")	125mm (5")	0.8mm (0.031")	90mm (3 1/2")	6
T4725ESD 10	5mm (3/16")	250mm (10")	0.8mm (0.031")	90mm (3 1/2")	6



ESD Screwdrivers - Pozidriv

DIN ISO 2380 , IEC 61340. 5.1 & 5.2

Item No.	Tip	Shaft Length	Tip Width	Tip Height	Weight
T4723ESD 0	PZO	3.5mm (9/64")	80mm (3 1/8")	70mm (2 3/4")	6
T4723ESD 1	PZ1	5.0mm (3/16")	80mm (3 1/8")	90mm (3 1/2")	6
T4723ESD 2	PZ2	6.0mm (7/32")	100mm (4")	100mm (4")	6



ESD Screwdrivers - Phillips

DIN ISO 2380 , IEC 61340. 5.1 & 5.2

Item No.	Tip	Shaft Length	Tip Width	Tip Height	Weight
T4722ESD 0	PH0	3.5mm (9/64")	60mm (2 3/8")	70mm (2 3/4")	6
T4722ESD 1	PH1	5.0mm (3/16")	80mm (3 1/8")	90mm (3 1/2")	6
T4722ESD 13	PH1	5.0mm (3/16")	300mm (12")	90mm (3 1/2")	6
T4722ESD 2	PH2	6.0mm (7/32")	100mm (4")	100mm (4")	6
T4722ESD 23	PH2	6.0mm (7/32")	300mm (12")	100mm (4")	6



ESD Screwdrivers - Torx Tamperproof

IEC 61340. 5.1 & 5.2

Item No.					
T4718ESD 08	T 08	3.0mm (1/8")	70mm (2 3/4")	80mm (3 1/8")	6
T4718ESD 0820	T 08	3.0mm (1/8")	200mm (8")	80mm (3 1/8")	6
T4718ESD 09	T 09	3.0mm (1/8")	70mm (2 3/4")	80mm (3 1/8")	6
T4718ESD 10	T 10	3.0mm (1/8")	80mm (3 1/8")	90mm (3 1/2")	6
T4718ESD 1030	T 10	3.0mm (1/8")	300mm (12")	90mm (3 1/2")	6
T4718ESD 15	T 15	3.5mm (9/64")	80mm (3 1/8")	90mm (3 1/2")	6
T4718ESD 1530	T 15	3.5mm (9/64")	300mm (12")	90mm (3 1/2")	1
T4718ESD 20	T 20	4.0mm (5/32")	90mm (3 1/2")	90mm (3 1/2")	6



ESD Bit Holder/Driver

IEC 61340. 5.1 & 5.2

Item No.					
T4582ESD	C 6.3 (1/4")	11mm (7/16")	125mm (5")	100mm (4")	6



ESD Screwdriver Set - Torx Tamperproof

For Torx tamperproof screws. CONTENTS: T4718ESD T08, T09, T10, T15 & T20.

Item No.		
T4730ESD	Set of 5	3



Triton ESD Screwdriver Set

T4741ESD CONTENTS: T4725ESD 3 x 75, 3 x 100 & 5 x 135mm, T4723ESD PZ0 x 60, PZ1 x 80 & PZ2 x 100mm. T4741SESD CONTENTS: T4725ESD 3 x 75, 3 x 100, 5 x 125mm. T4722ESD PH0 x 60, PH1 x 80, PH2 x 100.

Item No.			
T4741ESD	Set of 6	Slotted & Pozidriv	3
T4741SESD	Set of 6	Slotted & Phillips	3



ESD Screwdriver Set/6 - SL/PH/TX

Long reach screwdrivers. CONTENTS: T4725ESD 5 x 250mm, T4722ESD PH1 x 300 & PH2 x 300mm, T4718ESD T08 x 200, T10 x 300 & T15 x 300mm.

Item No.		
T4797ESD	Set of 6	1

Dissipative precision screwdrivers

1. Ergonomically designed handle with hollow rotating cap for ease of use and precise control.
2. Premium quality alloy steel blade for exceptional strength and durability.
3. Precision machined tip for an exact screw fit and damage free screwdriving.
4. Black anti-peel tips eliminate the risk of damage from flaking chrome.
5. Fully ESD compliant for safe use on sensitive electronic components.



Xonic ESD



ESD Electronic Screwdrivers - Slotted

IEC 61340. 5.1 & 5.2

Item No.	Blade Width	Blade Length	Tip Width	Tip Length	Quantity
T4880XES08	0.8mm (1/32")	60mm (2 3/8")	0.20mm (0.008")	97mm (3 13/16")	30
T4880XES12	1.2mm (3/64")	60mm (2 3/8")	0.25mm (0.010")	97mm (3 13/16")	30
T4880XES15	1.5mm (1/16")	60mm (2 3/8")	0.30mm (0.012")	97mm (3 13/16")	30
T4880XES18	1.8mm (5/64")	60mm (2 3/8")	0.30mm (0.012")	97mm (3 13/16")	30
T4880XES256	2.5mm (3/32")	60mm (2 3/8")	0.40mm (0.016")	97mm (3 13/16")	30
T4880XES257	2.5mm (3/32")	75mm (3")	0.40mm (0.016")	97mm (3 13/16")	30
T4880XES310	3.0mm (1/8")	100mm (4")	0.50mm (0.020")	97mm (3 13/16")	20
T4880XES315	3.0mm (1/8")	150mm (6")	0.50mm (0.020")	97mm (3 13/16")	10
T4880XES410	4.0mm (5/32")	100mm (4")	0.60mm (0.024")	97mm (3 13/16")	20
T4880XES415	4.0mm (5/32")	150mm (6")	0.60mm (0.024")	97mm (3 13/16")	10



ESD Screwdrivers - Pozidriv

IEC 61340. 5.1 & 5.2

Item No.	Type	Blade Width	Blade Length	Tip Length	Quantity
T4875X ESD	PZO	3.0mm (1/8")	60mm (2 3/8")	97mm (3 13/16")	30
T4875X ESD 1	PZI	4.5mm (11/64")	80mm (3 1/8")	97mm (3 13/16")	30



ESD Screwdriver - Phillips

IEC 61340. 5.1 & 5.2

Item No.	Type	Blade Width	Blade Length	Tip Length	Quantity
T4882X000ES	PH000	2.5mm (3/32")	60mm (2 3/8")	97mm (3 13/16")	30
T4882X00ESD	PH00	2.5mm (3/32")	60mm (2 3/8")	97mm (3 13/16")	30
T4882X0 ESD	PH0	3.0mm (1/8")	60mm (2 3/8")	97mm (3 13/16")	30
T4882X1 ESD	PH1	4.5mm (11/64")	80mm (3 1/8")	97mm (3 13/16")	30



ESD Screwdrivers - Torx

IEC 61340. 5.1 & 5.2

Item No.					
T4877XESD04	T 04	2.5mm (3/32")	50mm (2")	97mm (3 13/16")	30
T4877XESD05	T 05	2.5mm (3/32")	50mm (2")	97mm (3 13/16")	30
T4877XESD06	T 06	3.5mm (9/64")	50mm (2")	97mm (3 13/16")	30
T4877XESD07	T 07	3.5mm (9/64")	50mm (2")	97mm (3 13/16")	30
T4877XESD08	T 08	3.5mm (9/64")	60mm (2 3/8")	97mm (3 13/16")	30



Xonic Screwdrivers - Hex

IEC 61340. 5.1 & 5.2

Item No.					
T4838XESD15	3.2mm (1/8")	50mm (2")	2.5mm (3/32")	97mm (3 13/16")	30
T4838XESD20	3.5mm (9/64")	50mm (2")	2.5mm (3/32")	97mm (3 13/16")	30
T4838XESD25	4.0mm (5/32")	60mm (2 3/8")	3.0mm (1/8")	97mm (3 13/16")	30
T4838XESD30	4.5mm (11/64")	60mm (2 3/8")	3.5mm (9/64")	97mm (3 13/16")	30



Xonic Nut Spinner

IEC 61340. 5.1 & 5.2

Item No.					
T4840XESD32	3.2mm (1/8")	60mm (2 3/8")	4mm (5/32")	97mm (3 13/16")	30
T4840XESD35	3.5mm (9/64")	60mm (2 3/8")	4mm (5/32")	97mm (3 13/16")	30
T4840XESD40	4.0mm (5/32")	60mm (2 3/8")	4mm (5/32")	97mm (3 13/16")	30
T4840XESD45	4.5mm (11/64")	60mm (2 3/8")	4mm (5/32")	97mm (3 13/16")	30
T4840XESD50	5.0mm (3/16")	60mm (2 3/8")	4mm (5/32")	97mm (3 13/16")	30
T4840XESD55	5.5mm (7/32")	60mm (2 3/8")	4mm (5/32")	97mm (3 13/16")	30



Xonic Screwdriver Set/7

Slotted and Phillips screws. CONTENTS: T4880XESD 2.5 x 75, 3 x 100, 3 x 150, 4 x 100 & 4 x 150mm, T4882XESD PH0 x 60 & PH1 x 80mm.

IEC 61340. 5.1 & 5.2

Item No.		
T4883XESD	Set of 7	1



Xonic Screwdriver Set/4

Slotted and Phillips screws. CONTENTS: T4880XESD 1.8 x 60, 3 x 100 & 4 x 150mm, T4882XESD PH0 x 60mm.

IEC 61340. 5.1 & 5.2

Item No.		
T4884X ESD	Set of 4	1

Precision screwdrivers

1. Ergonomically designed handle with hollow rotating cap for ease of use and precise control.
2. Premium quality chrome vanadium steel blade for exceptional strength and durability.
3. Precision machined tip for an exact screw fit and damage free screwdriving.
4. Black anti-peel tips eliminates the risk of damage from flaking chrome.
5. Tip type colour coding for easy identification.

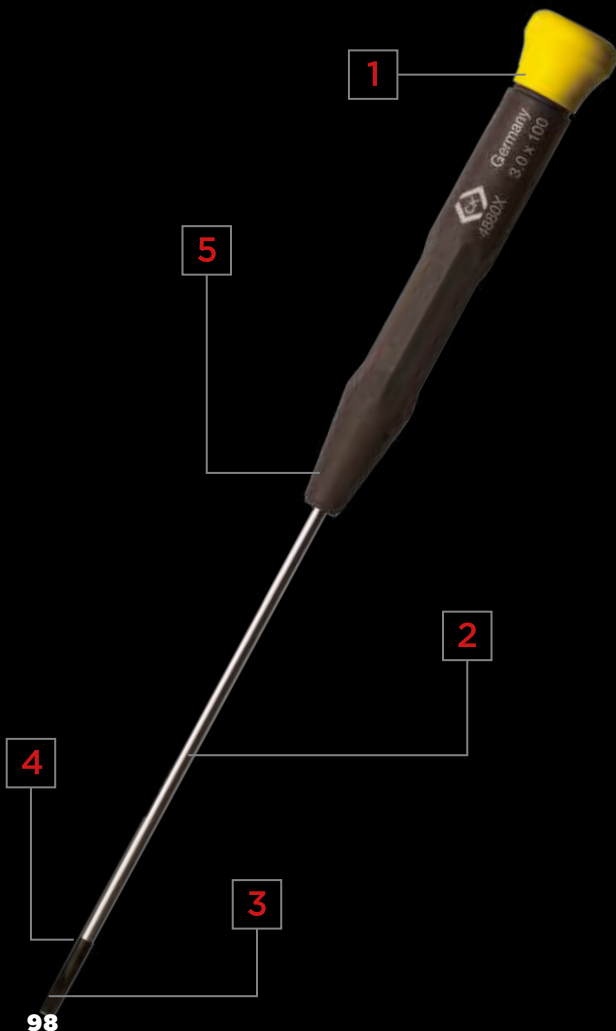

Xonic Precision Screwdrivers



Xonic Precision Screwdrivers - Slotted

Item No.					
T4880X 08	0.8mm (1/32")	60mm (2 3/8")	0.20mm (0.008")	97mm (3 13/16")	30
T4880X 12	1.2mm (3/64")	60mm (2 3/8")	0.20mm (0.008")	97mm (3 13/16")	30
T4880X 15	1.5mm (1/16")	60mm (2 3/8")	0.25mm (0.10")	97mm (3 13/16")	30
T4880X 18	1.8mm (5/64")	60mm (2 3/8")	0.30mm (0.012")	97mm (3 13/16")	30
T4880X 256	2.5mm (3/32")	60mm (2 3/8")	0.40mm (0.016")	97mm (3 13/16")	20
T4880X 257	2.5mm (3/32")	75mm (3")	0.40mm (0.016")	97mm (3 13/16")	30
T4880X 310	3.0mm (1/8")	100mm (4")	0.50mm (0.020")	97mm (3 13/16")	20
T4880X 315	3.0mm (1/8")	150mm (6")	0.50mm (0.020")	97mm (3 13/16")	10
T4880X 410	4.0mm (5/32")	100mm (4")	0.80mm (0.031")	97mm (3 13/16")	30
T4880X 415	4.0mm (5/32")	150mm (6")	0.80mm (0.031")	97mm (3 13/16")	10



Xonic Precision Screwdrivers - Phillips

Item No.					
T4882X 000	PH000	2.5mm (3/32")	60mm (2 3/8")	97mm (3 13/16")	30
T4882X 00	PH00	2.5mm (3/32")	60mm (2 3/8")	97mm (3 13/16")	1
T4882X 0	PH0	3.0mm (1/8")	60mm (2 3/8")	97mm (3 13/16")	10
T4882X 1	PH1	4.5mm (11/64")	80mm (3 1/8")	97mm (3 13/16")	30



Xonic Precision Screwdrivers - Torx

Item No.	Icon	Tip Size	Shaft Length	Handle Length	Quantity
T4877X 04	T 04	2.5mm (3/32")	50mm (2")	97mm (3 13/16")	30
T4877X 05	T 05	2.5mm (3/32")	50mm (2")	97mm (3 13/16")	30
T4877X 06	T 06	3.5mm (9/64")	50mm (2")	97mm (3 13/16")	30
T4877X 07	T 07	3.5mm (9/64")	50mm (2")	97mm (3 13/16")	30
T4877X 08	T 08	3.5mm (9/64")	60mm (2 3/8")	97mm (3 13/16")	30
T4877X 09	T 09	4.0mm (5/32")	60mm (2 3/8")	97mm (3 13/16")	30
T4877X 10	T 10	4.0mm (5/32")	80mm (3 1/8")	97mm (3 13/16")	30
T4877X 15	T 15	4.0mm (5/32")	80mm (3 1/8")	97mm (3 13/16")	30



Xonic Screwdriver Set/4

Slotted and Phillips screws. CONTENTS: T4880X 1.8 x 60, 3 x 100 & 4 x 150mm, T4882X PH0 x 60mm.

Item No.	Info Icon	Quantity	Box Icon
T4884X		Set of 4	1



Xonic Screwdriver Set/5

Slotted and Phillips screws. CONTENTS: T4880X 2.5 x 75, 3 x 100 & 4 x 100mm, T4882X PH00 x 60 & PH0 x 60mm.

Item No.	Info Icon	Quantity	Box Icon
T4880X/5		Set of 5	1



Xonic Screwdriver Set - Hex

Hexagon screws. CONTENTS: T4873X 0.7 x 50, 0.9 x 50, 1.3 x 50, 1.5 x 50, 2 x 50, 2.5 x 60 & 3 x 60mm.

Item No.	Info Icon	Quantity	Box Icon
T4874X		Set of 7	1



Xonic Screwdriver Set/7

Slotted and Phillips screws. CONTENTS: T4880X 2.5 x 75, 3 x 100, 3 x 150, 4 x 100 & 4 x 150mm, T4882X PH0 x 60 & PH1 x 80mm.

Item No.	Info Icon	Quantity	Box Icon
T4883X		Set of 7	1



Xonic Screwdriver Set - Torx

Torx screws. CONTENTS: T4877X T06, T07, T08, T09, T10, T15 & T20.

Item No.	Info Icon	Quantity	Box Icon
T4877PX		Set of 7	30

Precision Screwdrivers



VDE Screwdriver Set/7 - SL/PH

Designed to turn the smallest of screws with ease, the C.K VDE precision screwdriver combines the control of a rotating cap with the safety of VDE approval. Ergonomically designed handle with hollow rotating cap for ease of use & precise control. Premium quality chrome vanadium steel blade for exceptional strength & durability. Precision machined, magnetic tips for an exact screw fit & damage free screwdriving. VDE approved - individually tested to 10,000v for safe live working up to 1,000v. CONTENTS: Slotted sizes: 1.5, 1.8, 2.0, 2.5, 3.0 x 50mm, Phillips sizes: PH00, PH0 x 50mm.

Item No.	i	📦
T4897	Set of 7	24



Watchmakers Screwdriver Set/4 - SL

Slotted screws. CONTENTS: 1 x 15, 1.6 x 20, 2 x 22, 2.4 x 25mm.

Item No.	i	📦
T4852P	Set of 4	6



Watchmakers Screwdriver Set/6 - SL/PH

Slotted and Phillips screws. CONTENTS: 1 x 15, 1.6 x 20, 2 x 22, 2.4 x 25, PH00 x 25, PH0 x 25mm.

Item No.	i	📦
T4854P	Set of 6	6



Screwdriver Set/7 - SL/PH/TX

6 double ended blades. CONTENTS: Screwdriver handle, double ended blades, sizes: slotted 1.5mm x PH000, slotted 2.0mm x PH00, slotted 3.0 x PH0, slotted 4.0mm x PH1, TX05 x TX06 & TX07 x TX08.

Item No.	i	📦
T4896	Set of 7	6

Precision Ceramic Trimmers



Ceramic Trimmers - Slotted

Item No.	🌀	↔️	🌀	↔️	📦
T4845 09	0.9mm (.035")	15mm (5/8")	0.4mm (.016")	85mm (3 3/8")	10
T4845 13	1.3mm (.051")	15mm (5/8")	0.4mm (.016")	85mm (3 3/8")	10
T4845 18	1.8mm (.071")	15mm (5/8")	0.4mm (.016")	85mm (3 3/8")	10
T4845 26	2.6mm (.102")	15mm (5/8")	0.4mm (.016")	85mm (3 3/8")	10



Ceramic Trimmers - Phillips

Item No.	⊕	🌀	↔️	↔️	📦
T4847	PH 0	2.6mm (.102")	15mm (5/8")	85mm (3 3/8")	10
T4847 0	PH 0 spec	2.6mm (.102")	15mm (5/8")	85mm (3 3/8")	10



precision

Ceramic trimmers

Ceramic Trimmers - 4 in 1

4 ceramic blades in 1 tool. 2 reversible inserts with 2 ceramic blades each. Transparent protection caps. Antistatic handle. With protection cap fitted, the blade inserts can be used as mini-alignment tools.

Item No.	⊖	⊕	⊖	⊕	📦
T4856	0.9mm (.035")	PH 0 spec	1.8mm (.071")	PH 0	10
T4856A	0.9mm (.035")	PH 0 spec	1.8mm (.071")	2.6mm (.102")	10
Z4856 1					1
Z4856 2					1
Z4856 3					1

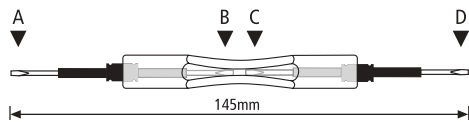

Plastic Trimmers



Plastic Trimmer Set/7

Contents each 1 piece: Slotted with polycarbonate tip 0.5 x 1.2 / 0.5 x 1.5 / 0.7 x 2.4, Slotted with brass tip 0.5 x 1.0 / 0.5 x 2.0 / 0.7 x 1.5 / 0.7 x 2.5.

Item No.	i	📦
T4844	Set of 7	1

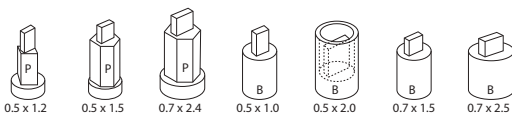

Plastic Trimmer Set/10

Set of economy single ended trimming tools with 10 different heads for delicate trimming of electronic equipment. Manufactured from moulded/thermoplastic material. Contents of set, each 1 piece: 0.7 x 1.0mm square / 0.5 x 1.3mm and 0.8 x 2.3mm hexagon / Slotted: 0.7 x 2.0 / 0.7 x 2.4 / 0.7 x 1.0 / 0.8 x 1.3 / 0.8 x 1.8 / 0.7 x 2.4. and 1.3mm.

Item No.	i	📦
T4857	Set of 10	3

1. Zirconia ceramic tips - safe trimming of highly sensitive electrical components, highly acid resistant (other than Hydrofluoric), solder repellent and electrically non-conductive.
2. Heat resistant up to 1000°C for safe use.
3. Non-magnetic to prevent electro-magnetic damage.



Precision Wire Strippers



Fibre Optic Stripper

For damage free wire preparation every time. Blades accurately ground and fully hardened for long life. 50mm scale with 1mm graduations and length stop. Compact design.

Item No.	Ø	
T3755 018	0.18mm	1



Precision Wire Stripper

Compact precision wire strippers for repeatable, damage free stripping of PVC, Teflon & similar coated wire. Graduated depth stop for stripping to precise lengths. Specially hardened blades for outstanding long term performance. 50mm scale with 1mm graduations and length stop.

Item No.	Ø	
T3756 20	0.20mm	1
T3756 25	0.25mm	1
T3756 30	0.30mm	1
T3756 40	0.40mm	1
T3756 50	0.50mm	1
T3756 60	0.60mm	1
T3756 80	0.80mm	1
T3756 100	1.0mm	1



Adjustable Precision Wire Stripper

Compact precision wire strippers for repeatable, damage free stripping of PVC, Teflon & similar coated wire. Graduated depth stop for stripping to precise lengths. Specially hardened blades for outstanding long term performance. Adjustable to strip 6 wire diameters.

Item No.	Ø	
330009	0.12, 0.16, 0.20, 0.25, 0.30, 0.40mm	1
330013	0.25, 0.30, 0.40, 0.50, 0.60, 0.80mm	1
330011	0.30, 0.40, 0.50, 0.60, 0.80, 1.0mm	1



ESD Precision Wire Stripper

Adjustable - damage free wire preparation every time. Fully ESD compliant for safe use on sensitive electronic components. Blades accurately ground and fully hardened for long life. 50mm scale with 1mm graduations and length stop. Adjustable to strip 6 wire diameters. Compact design. For solid and stranded wire with PVC, PTFE or similar insulation. IEC 61340. 5.1 & 5.2

Item No.	Ø	
T3757ESD 1	0.12, 0.16, 0.20, 0.25, 0.30, 0.40mm	1
T3757ESD 2	0.25, 0.30, 0.40, 0.50, 0.60, 0.80mm	1
T3757ESD 3	0.30, 0.40, 0.50, 0.60, 0.80, 1.00mm	1



Strip Cut Wire Stripper

Easily adjustable to 6 wire diameters. Adjustable length stop with 15mm scale. Precision metal cutting and stripping blade, hardened. Integrated wire cutter for copper wires up to 0.8mm.

Item No.	Ø	
330012	0.25, 0.30, 0.40, 0.50, 0.60, 0.80mm	1



ESD Wire Stripper Spares

Set of replacement blades for C.K Precision Wire Strippers.

Item No.	i	📦
Z3757 2	330013 / T3757ESD 2, 0.25 - 0.8mm	1
Z3757 3	330011 / T3757ESD 3, 0.3 - 1mm	1

Other



ESD Desoldering Tool

High capacity pump with 14.5cm³ volume. Body made from antistatic high quality glass fibre reinforced nylon. Heat resistant & conductive carbon fibre tip. Suction pressure can be increased or decreased by turning the spring around. IEC 61340. 5.1 & 5.2

Item No.	↔	📦
T6103A	210mm (8 1/4")	1



ESD Desoldering Tool Nozzle

Spare nozzle for C.K desoldering pump T6103A. Nozzle made of Carbon. IEC 61340. 5.1 & 5.2

Item No.	📦
T6104A	1



PLCC Extractor

Avoids the damage of PLCC components when extracting. Self opening for repetitive action. Hardened stainless steel sockets. Made from dissipative thermoplastic material. For all PLCC-components (20-124 pins).

Item No.	↔	📦
T2371	100mm (4")	6



ESD Ball Pen

Designed for ESD sensitive areas, and normal use. Writing color: Blue. DIN EN 61340 5.1 & 5.2

Item No.	📦
Z1123	1



Magnetic Pickup Pointer & Pen

Multi-use product for use in the workshop, office or home. The magnetic pick-up pointer extends to 630mm / 24.3/4". Unscrew the magnetic tip to reveal the pen which accommodates standard refills. With pocket clip.

Item No.	📦
T1355	50



Power Tool Accessories

Masonry Drill Bits	106
Metal Drill Bits	108
Fast4 Fluted Bits	110
Wood Drill Bits	111
Multi-Material	113
ProCobalt Holesaws	114
Arbors & Accessories	117
Blue Steel Impact Bits	118
Screwdriver Bits	121
Screwdriver Bit Holders	126
Multitool Blades	127
Jigsaw Blades	128
Reciprocating Blades	129

Masonry Drill Bits



SDS+ Concrete Drill Bits

Tungsten carbide tipped with optimized geometry for drilling concrete and stone. Vacuum brazed tips for durability. Ground flutes designed for optimum debris removal. SDS+ shank.

Item No.	Ø			
T3120 0411	4mm	48mm	110mm	5
T3120 0511	5mm	48mm	110mm	5
T3120 0516	5mm	90mm	160mm	5
T3120 05511	5.5mm	48mm	110mm	5
T3120 05516	5.5mm	90mm	160mm	5
T3120 0611	6mm	48mm	110mm	5
T3120 0616	6mm	90mm	160mm	5
T3120 0621	6mm	140mm	210mm	5
T3120 06516	6.5mm	90mm	160mm	5
T3120 0711	7mm	48mm	110mm	5
T3120 0716	7mm	90mm	160mm	5
T3120 0816	8mm	90mm	160mm	5
T3120 0821	8mm	140mm	210mm	5
T3120 0826	8mm	185mm	260mm	5
T3120 0845	8mm	350mm	450mm	5
T3120 1016	10mm	90mm	160mm	5
T3120 1021	10mm	140mm	210mm	5
T3120 1026	10mm	185mm	260mm	5
T3120 1045	10mm	350mm	450mm	5
T3120 1215	12mm	90mm	160mm	5
T3120 1221	12mm	140mm	200mm	5
T3120 1225	12mm	180mm	260mm	5
T3120 1245	12mm	350mm	450mm	5
T3120 1425	14mm	180mm	260mm	5
T3120 1445	14mm	350mm	450mm	5
T3120 1630	16mm	250mm	310mm	5
T3120 1645	16mm	350mm	450mm	5
T3120 1830	18mm	250mm	310mm	5
T3120 1845	18mm	350mm	450mm	5
T3120 2030	20mm	250mm	310mm	5
T3120 2045	20mm	350mm	450mm	5
T3120 2545	25mm	350mm	450mm	5
T3120 12100	12mm	950mm	1000mm	5
T3120 16100	16mm	950mm	1000mm	5
T3120 20100	20mm	950mm	1000mm	5
T3120 25100	25mm	950mm	1000mm	5



SDS Concrete Drill Bit Set/7



CONTENTS: 5 x 110mm / 6 x 110mm / 8 x 110mm / 6 x 150mm / 8 x 150mm / 10 x 150mm & 12 x 150mm.

Item No.	
T3121	5



SDS Flat Chisel Bits



SDS+ chisels. Hardened carbon steel for durability.

Item No.			
T3146	20mm	250mm	6
T3147	40mm	250mm	6



SDS Point Chisel Bit

SDS+ chisel. Hardened carbon steel for durability.

Item No.			
T3145	Point	250mm	6



SDS Masonry Drill Bit Set/14

Multiple quantities of most commonly used sizes. Drill bits supplied in roll up storage case offering a convenient long term storage solution. Tungsten carbide tipped for speed, performance and endurance. For rotary and percussion drills. CONTENTS: 5 x 110mm (x2); 5.5 x 110mm (x3); 6 x 110mm (x3); 5.5 x 160mm (x2); 6 x 160mm (x2); 7 x 160mm (x1); 8 x 160mm (x1).

Item No.		
T3132	Set of 14	3



SDS Masonry & Chisel Set/15

Drill bits supplied in roll up storage case offering a convenient long term storage solution. Tungsten carbide tipped for speed, performance and endurance. For rotary and percussion drills. Contents of set, each 1 piece: 5 x 110mm / 5 x 160mm / 5.5 x 110mm / 5.5 x 160mm / 6 x 110mm / 6 x 160mm / 6 x 210mm / 6.5 x 160mm / 7 x 160mm / 8 x 160mm / 10 x 160mm & 12 x 160mm, Point chisel in 250mm / Flat chisel in 20 x 250mm and Scaling chisel in 40 x 250mm.

Item No.		
T3133	Set of 25	3



Masonry Drill Bit Set/5

Forged steel with tungsten carbide tip. Optimised design for fast and accurate drilling of concrete, stone & brick. CONTENTS: 1 of each size: 4, 5.5, 6.5, 7 & 8mm.

Item No.	
T3111	5



Masonry Drill Bits

Forged steel with tungsten carbide tip. Optimised design for fast and accurate drilling of concrete, stone & brick.

Item No.	∅		
T3110 0475	4mm	75mm	10
T3110 0585	5mm	85mm	10
T3110 05150	5mm	150mm	10
T3110 05585	5.5mm	85mm	10
T3110 055150	5.5mm	150mm	10
T3110 06100	6mm	100mm	10
T3110 06150	6mm	150mm	10
T3110 065100	6.5mm	100mm	10
T3110 065150	6.5mm	150mm	10
T3110 07100	7mm	100mm	10
T3110 07150	7mm	150mm	10
T3110 08150	8mm	150mm	10
T3110 10150	10mm	150mm	10
T3110 12150	12mm	150mm	10
T3110 13150	13mm	150mm	10
T3110 14150	14mm	150mm	10
T3110 16150	16mm	150mm	10



Masonry Hex Drill Bit Set/5

Forged steel with tungsten carbide tip. Optimised design for fast and accurate drilling of concrete, stone & brick. With 4mm hexagonal shaft. CONTENTS: 1 of each size: 4, 5.5, 6.5, 7 & 8mm.

Item No.		
T3112	4mm	5

Metal Drill Bits



HSS Split Point Drill Bits

High speed steel. 135° split point design for non-wander starting. Flute ground for accurate results.

DIN338

Item No.	Ø				
T3100 01	1mm	12mm	34mm	Loose	10
T3100 015	1.5mm	18mm	40mm	Loose	10
T3100 02	2mm	24mm	49mm	Loose	10
T3100 025	2.5mm	30mm	57mm	Loose	10
T3100 03	3mm	33mm	61mm	Loose	10
T3100 035	3.5mm	39mm	70mm	Loose	10
T3100 04	4mm	43mm	75mm	Loose	10
T3100 045	4.5mm	47mm	80mm	Loose	10
T3100 05	5mm	52mm	86mm	Loose	10
T3100 055	5.5mm	57mm	93mm	Loose	10
T3100 06	6mm	57mm	93mm	Loose	10
T3100 065	6.5mm	63mm	101mm	Loose	10
T3100 07	7mm	69mm	109mm	Loose	10
T3100 08	8mm	75mm	117mm	Loose	10
T3100 09	9mm	81mm	125mm	Loose	10
T3100 10	10mm	87mm	133mm	Loose	10
T3100 11	11mm	94mm	142mm	Loose	10
T3100 12	12mm	101mm	151mm	Loose	10
T3100 13	13mm	101mm	151mm	Loose	10
T3100 045D	4.5mm	47mm	80mm	Single Pack	6
T3100 05D	5mm	52mm	86mm	Single Pack	6
T3100 055D	5.5mm	57mm	93mm	Single Pack	6
T3100 06D	6mm	57mm	93mm	Single Pack	6
T3100 065D	6.5mm	63mm	101mm	Single Pack	6
T3100 07D	7mm	69mm	109mm	Single Pack	6
T3100 08D	8mm	75mm	117mm	Single Pack	6
T3100 09D	9mm	81mm	125mm	Single Pack	6
T3100 10D	10mm	87mm	133mm	Single Pack	6
T3100 11D	11mm	94mm	142mm	Single Pack	6
T3100 12D	12mm	101mm	151mm	Single Pack	6
T3100 13D	13mm	101mm	151mm	Single Pack	6
T3100 01TD	1mm	12mm	34mm	Twin Pack	6
T3100 015TD	1.5mm	18mm	40mm	Twin Pack	6
T3100 02TD	2mm	24mm	49mm	Twin Pack	6
T3100 025TD	2.5mm	30mm	57mm	Twin Pack	6
T3100 03TD	3mm	33mm	61mm	Twin Pack	6
T3100 035TD	3.5mm	39mm	70mm	Twin Pack	6
T3100 04TD	4mm	43mm	75mm	Twin Pack	6



Masonry Colour Drill Bit Sets

For rotary and percussion drills. Tungsten carbide tipped - for speed, performance and endurance. Colour coded sizes - for quick and convenient identification of the correct size drill for wall fixings. CONTENTS: 3 x 5mm, 3 x 6mm, 3 x 7mm.

Item No.	
T3113	12
T3113CLIP	1



Masonry Drill Bit Set/25

Multiple quantities of most commonly used sizes. Drill bits supplied in roll up storage case offering a convenient long term storage solution. Tungsten carbide tipped for speed, performance and endurance. For rotary and percussion drills. CONTENTS: 4 x 75mm (x3); 5.5 x 85mm (x5); 5.5 x 150mm (x5); 6 x 100mm (x5); 6 x 150mm (x3); 7 x 100mm (x2); 7 x 150mm (x2).

Item No.		
T3131	Set of 25	3



Cobalt Split Point Drill Bit Set

Suitable for a range of materials including: steel, aluminium, wood, plastic, laminated sheet and particle board. CONTENTS: 2, 3, 4, 5, 6, 8mm shank. Material: M35, cobalt steel. DIN 338

Item No.	
T3104	1



HSS Split Point Drill Bit Set/6

High speed steel. 135° split point design for non-wander starting. Flute ground for accurate results. CONTENTS: 2, 3, 4, 5, 6 & 8mm. DIN 338

Item No.	
T3101	3



HSS Split Point Drill Bit Set/13

High speed steel. 135° split point design for non-wander starting. Flute ground for accurate results. CONTENTS: 1.5, 2, 2.5, 3, 3.2, 3.5, 4, 4.5, 4.8, 5, 5.5, 6 & 6.5mm. DIN 338

Item No.	
T3102	3



HSS Split Point Drill Bit Set/19

High speed steel. 135° split point design for non-wander starting. Flute ground for accurate results. CONTENTS: 1, 1.5, 2, 2.5, 3, 3.5, 4, 4.5, 5, 5.5, 6, 6.5, 7, 7.5, 8, 8.5, 9, 9.5 & 10mm. DIN 338

Item No.	
T3103	1



HSS Multi-Step Drills

Centres, drills and deburrs sheet metals in one operation. HSS, precision ground for accurate drilling. Dual flute construction for faster drilling & longer life. Three flats on drive shaft for secure drive in drill chucks.

Item No.		
T3010 1	4, 6, 8, 10, 12, 14, 16, 18 & 20mm	1
T3008	6, 9, 12.3, 15.2, 18.6, 20.4, 22.5, 25.4, 28.3 & 30.5mm	1
T3011	6 8 10 12 14 16 18 20 22 24 26 28 30 32mm	1
T3012	12.5, 12.7, 15.2, 16.2, 18.6, 20.4, 22.5, 25.4, 28.3, 30.5 & 32.5mm	1



High Speed Steel Cone Drills

Centres, drills and deburrs sheet metals in one operation. HSS, precision ground for accurate drilling. Dual flute construction for faster drilling & longer life. Three flats on drive shaft for secure drive in drill chucks.

Item No.		
T3014	6 - 26mmØ	1
T3015	16 - 32mmØ	1



TiN Coated Multi-Step Drill

Centres, drills and deburrs sheet metals in one operation. Titanium coated for longer life. HSS, precision ground for accurate drilling. Dual flute construction for faster drilling & longer life. Three flats on drive shaft for secure drive in drill chucks.

Item No.	Ø	
T3013	6, 8, 10, 12, 14, 16, 18, 20, 22, 24, 36, 28, 30 & 32mmØ	1

Fluted bits

1. 4 bladed design:
Offering 100% more cutting surface than a traditional flat bit for faster drilling.
2. Pilot screw point:
Allows accurate positioning and pull through.
3. Optimised flute geometry:
Waste is removed faster for a cleaner cut and finish.



Fast4 Fluted Bits



Fast4 Wood Drill Bits

Precision ground cutting edges with outer spur blades for a smoother cut & cleaner breakout. Clean hole results.

Item No.	Ø	Length	Flute Length	Icon
T2943-16	16mm	110mm	160mm	10
T2943-20	20mm	110mm	160mm	10
T2943-22	22mm	110mm	160mm	10
T2943-25	25mm	110mm	160mm	10
T2943-32	32mm	110mm	160mm	10
T2943S4				1



Fast4 SDS+ Wood Drill Bits

Precision ground cutting edges with outer spur blades for a smoother cut & cleaner breakout. Clean hole results. SDS drive.

Item No.	Ø	Length	Flute Length	Icon
T2944-16	16mm	110mm	160mm	10
T2944-20	20mm	110mm	160mm	10
T2944-22	22mm	110mm	160mm	10
T2944-25	25mm	110mm	160mm	10
T2944-32	32mm	110mm	160mm	10



Fast4Access Wood Drill Bits

50% shorter for better access. Precision ground cutting edges with outer spur blades for a smoother cut & cleaner breakout. Clean hole results.

Item No.	Ø	Length	Flute Length	Icon
T2945-16	16mm	50mm	80mm	100
T2945-20	20mm	50mm	80mm	50
T2945-22	22mm	50mm	80mm	50
T2945-25	25mm	50mm	80mm	50



Fast4Nails Wood Drill Bits

Designed for use with Nail Embedded Timber; Chipboard, Blockboard, Particle board, Laminated sheet. HSS Bi-Metal construction for increased durability. Extended working life on nail embedded wood. 4 blades for faster drilling. 6.35 Hex Shank for convenience and ease of use.

Item No.	Ø	Length	Flute Length	Icon
T2946-16	16mm	60mm	120mm	90
T2946-20	20mm	60mm	120mm	70
T2946-22	22mm	60mm	120mm	70
T2946-25	25mm	60mm	120mm	70
T2946-32	32mm	60mm	120mm	50

Wood Drill Bits



Flat Wood Bits

HSS, hardened for long life performance. Brad pointed for accurate drill starts. Ground wing spur for clean hole cutting. Quick lock direct E6.3 drive.

Item No.	Ø			
T2942-06	6mm	130mm	160mm	5
T2942-08	8mm	130mm	160mm	5
T2942-10	10mm	130mm	160mm	5
T2942-12	12mm	130mm	160mm	5
T2942-13	13mm	130mm	160mm	5
T2942-14	14mm	130mm	160mm	5
T2942-16	16mm	130mm	160mm	5
T2942-20	20mm	130mm	160mm	5
T2942-22	22mm	130mm	160mm	5
T2942-25	25mm	130mm	160mm	5
T2942-28	28mm	130mm	160mm	5
T2942-32	32mm	130mm	160mm	5
T2942-38	38mm	130mm	160mm	5
T2942-12400	12mm	370mm	400mm	15
T2942-16400	16mm	370mm	400mm	15
T2942-20400	20mm	370mm	400mm	15
T2942-25400	25mm	370mm	400mm	5
T2942-32400	32mm	370mm	400mm	5



Heavy Duty Flat Wood Bits

For use on Nail Embedded Timber; Chipboard, Blockboard, Particle board, Laminated sheet. Heavy duty carbon steel construction for exceptional performance. Bevelled pilot-point reduces bit walk for faster drilling and clean holes. Impact ready hex shank with oversized shaft for greater strength and durability.

Item No.	Ø			
T2952-10	10mm	120mm	152mm	6
T2952-12	12mm	120mm	152mm	6
T2952-14	14mm	120mm	152mm	6
T2952-16	16mm	120mm	152mm	6
T2952-20	20mm	120mm	152mm	6
T2952-22	22mm	120mm	152mm	6
T2952-25	25mm	120mm	152mm	6
T2952-28	28mm	120mm	152mm	6
T2952-32	32mm	120mm	152mm	6
T2952-38	38mm	120mm	152mm	6



Flat Wood Bits Set

Professional quality HSS construction. Brad pointed for accurate drill starts. Ground wing spur for clean hole cutting. Quick lock direct E6.3 drive. CONTENTS: 6 x flat bits, sizes: 10, 13, 16, 20, 22 & 25mm.

Item No.	
T2942P	5



Flat Wood Bit Extension Drive

Extension drive shaft for flat bits with E6.3 drive.

Item No.		
T2940-2	300mm	30



Quick Release Extension Bar - 3 Pack

Quick release for a fast and convenient bit change. Gives greater access to awkward screws and drilling locations. Impact rated 6.35 hex shank for all common power tools. CrV (chrome vanadium) shaft for increased strength and durability. 3 different sizes for all applications.

Item No.		
T2940-3	60mm, 150mm & 300mm	30



Flat Bits - Long Stocked Display



CONTENTS: 3 x flat bits, sizes: 12 x 400mm, 16 x 400mm, 20 x 400mm, 4 x flat bits, sizes: 25 x 400mm, 2 x flat bits, size: 32 x 400mm.

Item No.	
T2942LS	1



Auger Wood Bits - Short

HSS, hardened for long life performance. Spur lip for clean hole results. Screw tip for precise hole starts. Combination shank suitable for hand and power drills.

Item No.	∅			
T3033 13	13mm	50mm	100mm	6
T3033 22	22mm	80mm	130mm	6



Auger Wood Bits - Standard



HSS, hardened for long life performance. Spur ground external edge for clean hole cutting. Screw tip for precise hole starts. Combination shank suitable for hand & power drills.

Item No.	∅			
T3031 06	6mm	90mm	160mm	6
T3031 08	8mm	100mm	170mm	6
T3031 10	10mm	120mm	190mm	6
T3031 13	13mm	120mm	190mm	6
T3031 16	16mm	130mm	200mm	6
T3031 20	20mm	140mm	210mm	6
T3031 22	22mm	140mm	210mm	6
T3031 25	25mm	140mm	210mm	6
T3031 30	30mm	140mm	210mm	6
T3031 32	32mm	140mm	210mm	6



Auger Wood Bits - Long



HSS, hardened for long life performance. Spur ground external edge for clean hole cutting. Screw tip for precise hole starts. Combination shank suitable for hand & power drills.

Item No.	∅			
T3034 10	10mm	220mm	300mm	6
T3034 13	13mm	220mm	300mm	6
T3034 16	16mm	220mm	300mm	6
T3034 20	20mm	220mm	300mm	6
T3034 22	22mm	220mm	300mm	6
T3034 25	25mm	220mm	300mm	6



Wood Drill Bits

Chrome vanadium steel for long life performance. Brad pointed for accurate drill starts. Spur ground external edge for clean hole cutting.

Item No.	∅			
T3035 03	3mm	33mm	61mm	10
T3035 04	4mm	43mm	75mm	10
T3035 05	5mm	52mm	86mm	5
T3035 06	6mm	60mm	97mm	5
T3035 08	8mm	75mm	117mm	5
T3035 10	10mm	87mm	133mm	5
T3035 12	12mm	96mm	151mm	5
T3035 13	13mm	96mm	151mm	5
T3035 14	14mm	97mm	151mm	5
T3035 16	16mm	100mm	160mm	3



Wood Drill Bit Set/5

Chrome vanadium steel for long life performance. Brad pointed for accurate drill starts. Spur ground external edge for clean hole cutting. CONTENTS: 4, 5, 6, 8 & 10mm.

Item No.	
T3040	3



Countersink Bit

HSS, hardened for long life performance. 1/2", 13 x 90°.

Item No.		
T2601S 5090	13 x 90°	6

Multi-Material



Glass/Tile Drill Bit Set

Tungsten carbide tipped drill set for easy drilling of glass and ceramics. Titanium nitride coated for wear protection. CONTENTS: 4, 5, 6, 7, 10mm 1/4" quick change hex shank.

Item No.	
T3059	1



Universal Drill Bit Set

Tungsten carbide tipped drills specially designed for drilling through concrete, brick, cement, stone, metal & ceramics. CONTENTS: 4, 5, 6, 8 & 10mm.

Item No.	
T3063	3



Combination Drill Bit Set

Masonry, Metal & Wood Drill Bit Set, 16 pieces. Contents each 1 piece: For Brick: 4, 5.5, 6.5, 7, 8mm, For Metal: 2, 3, 4, 5, 6, 8mm, For Wood: 4, 5, 6, 8, 10mm.

Item No.	
T3064B	10



TiN Drill Saw - Twin Pack

Titanium nitride coated HSS for strength and durability. Drills and cuts to create any size shape or hole. Self-starting tip. Cuts through wood/plastic up to 5mm, aluminium up to 4mm and metal up to 3mm thick. Pack includes 2 drill saws.

Item No.		
T3193T	6mm	3

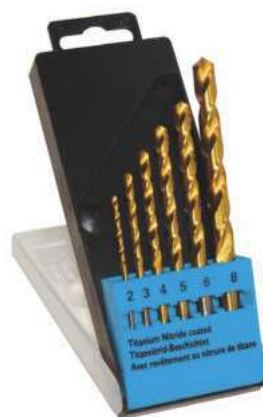

TiN Drill Bit Set/6

135° Forged HSS steel. Precision ground for accurate drilling. Titanium nitride coated for extra wear protection. CONTENTS: 2, 3, 4, 5, 6, 8mm.

Item No.	
T3293	3



TiN Drill Bit Set/19

135° Forged HSS steel. Precision ground for accurate drilling. Titanium nitride coated for extra wear protection. CONTENTS: 1, 1.5, 2, 2.5, 3, 3.5, 4, 4.5, 5, 5.5, 6, 6.5, 7, 7.5, 8, 8.5, 9, 9.5, 10mm.

Item No.	
T3291	3

Holesaws

The ultimate in performance, reliability and output. One saw does it all. Cuts metal, wood, plasterboard and composites.

1. Vari-pitch tooth design optimised for a faster cut.
2. Location pins to avoid over tightening for easier removal.
3. Improved heat dissipation and slug removal access.



Holesaws



ProCobalt Holesaws

Premium grade 8% cobalt alloy steel construction for an extended working life. Excellent wear resistance even at high temperatures. For fast and clean cutting of metal, wood, aluminium, steel, cast iron, brass and plastics. Variable pitch teeth for rapid cutting action, efficient swarf removal and reduced vibration.

Item No.	Ø	Box
424001	16mm (5/32")	10
424002	19mm (3/4")	10
424003	20mm (25/32")	10
424005	22mm (7/8")	10
424006	25mm (1")	10
424007	29mm (1 1/8")	10
424008	32mm (1 1/4")	10
424010	38mm (1 1/2")	10
424011	40mm (1 5/16")	10
424012	41mm (1 5/8")	10
424013	43mm (1 11/16")	10
424014	44mm (1 3/4")	10
424015	48mm (1 7/8")	10
424016	51mm (2")	10
424017	54mm (2 1/8")	10
424018	57mm (2 1/4")	10
424019	60mm (2 3/8")	10
424020	64mm (2 1/2")	10
424021	65mm (2 9/16")	10
424022	67mm (2 5/8")	10
424023	68mm (2 11/16")	10
424024	70mm (2 3/4")	10
424025	73mm (2 7/8")	10
424026	76mm (3")	10
424027	79mm (3 1/8")	10
424028	83mm (3 1/4")	10
424029	86mm (3 3/8")	10
424030	89mm (3 1/2")	10
424031	92mm (3 5/8")	10
424032	95mm (3 3/4")	10
424033	102mm (4")	10
424034	105mm (4 1/8")	10
424035	111mm (4 3/8")	10
424036	114mm (4 1/2")	10
424050	127mm (5")	10
424060	152mm (6")	10



Holesaw Kit - 6 Piece

CONTENTS: 1 x holesaw, sizes: 40, 54, 65, 67 & 68mm. Quick release arbor 32 - 152mm (11mm shaft).

Item No.	
424044	10



Electricians Hole Saw Kit - 9 Piece

CONTENTS: 1 x holesaw, sizes: 16, 20, 25, 32, 38 & 51mm. Arbor 14 - 30mm (8mm shaft). Quick release arbor 32 - 114mm (11mm shaft). Hexagon key 4mm.

Item No.	
424045	10



Holesaw Kit - 9 Piece

CONTENTS: 1 x holesaw, sizes: 22, 29, 35, 44, 51 & 64mm. Arbor 14 - 30mm (8mm shaft). Locking arbor 32 - 152mm (11mm shaft). Hexagon key 4mm.

Item No.	
424043	10



Holesaw Display - Stocked Stand

CONTENTS: 1 x holesaw, sizes: 16, 19, 20, 22, 25, 29, 32, 38, 40, 44, 48, 51, 54, 57, 60, 64, 65, 67, 70, 73, 76, 79, 83, 89, 92, 95, 102, 105, 111 & 114mm. 1 x arbor 14-30mm (8mm shaft). 1 x arbor 14-30mm (11mm shaft). 1 x quick release arbor 32-114mm (11mm shaft). 1 x locking arbor 32-114mm (11mm shaft). 1 x SDS arbor 14-30mm. 1 x SDS quick release arbor 32-114mm. 1 x replacement pilot drill (for 424037, 424047 & 424048). 1 x replacement pilot drill (for 424038, 424039 & 424040). 1 x extension drive.

Item No.	i	
400002	Stock & stand	1



Downlight Hole Saw Kit - 6 Piece

CONTENTS: 1 x holesaw, sizes: 65, 70, 76 & 83mm. Quick release arbor 32 - 114mm (11mm shaft). Hexagon key 4mm.

Item No.	
424046	10



Sheet Steel Holesaws

Tooth configuration optimised for the fast cutting of sheet steel. Cuts sheet steel faster than standard holesaws. 8 teeth per inch for a smoother cutting action. Cleaner holes with no burring. Premium grade 8% cobalt alloy steel construction for an extended working life. Slimline design reduces frictional heat build up and prevents tooth burn out compatible with impact drills. E6.3 drive system. Flared shoulders prevent overdrilling, avoids damaging inner components of electrical cabinets and junction boxes.

Item No.	Ø	
T3202 016	16mm	10
T3202 020	20mm	10
T3202 022	22mm	10
T3202 025	25mm	10
T3202 032	32mm	10
T3202 038	38mm	10
T3202 040	40mm	10



Sheet Steel Holesaw Set/3

Tooth configuration optimised for the fast cutting of sheet steel. Cuts sheet steel faster than standard holesaws. 8 teeth per inch for a smoother cutting action. Cleaner holes with no burring. Premium grade 8% cobalt alloy steel construction for an extended working life. Slimline design reduces frictional heat build up and prevents tooth burn out. Compatible with impact drills. E6.3 drive system. Flared shoulders prevent overdrilling, avoids damaging inner components of electrical cabinets and junction boxes. CONTENTS: 20, 25 & 32mm.

Item No.		
T3213	Set of 3	3



TCT HoleSaw Pilot Bit & Spring (3pc)

HSS pilot bit for C.K TCT hole saws. 6.0mm diameter.

Item No.		
T3218	6.0mm	6
T3212		20



Sheet Steel Holesaw Display

CONTENTS: 2 x 16mm, 2 x 20mm, 2x 22mm, 2 x 25mm, 2 x 32mm & 2 x 28mm.

Item No.		
T3202R	Stock and backing card	1



Adjustable Hole Cutter

Tri-Cut design for accurate, clean holes 19 - 127mm. Synchronised blade adjustment for faster sizing. Integrated measuring guide for a variety of hole cutting applications. Suitable for downlights, ventilation and electrical outlet installation HSS split point pilot bit for reduced bit walk. Carbon Steel teeth provide exceptional cutting performance in plasterboard, softwood and OSB. Shroud to capture dust and debris, keeping you and your work site cleaner. 6.35mm hex shank for secure fitment. No additional arbor or attachments required. 2 sets of teeth comprising of three blades, Set 1 for hole sizes 19 - 100mm and Set 2 for hole sizes 45 - 127mm.

Item Number	Ø	
T3230	19 - 127mm	24
T3231	Set of 6	1



TCT Hole Saws

Tungsten Carbide Tip (TCT) for exceptional cutting performance across mild and stainless steel, cast iron and copper up to a 12mm thickness. 3-point variable cutting edge for maximum contact whilst minimising heat build-up. High tension spring for rapid slug ejection.

Item No.		Ø	
T3203 016	16mm	12mm	6
T3203 020	20mm	12mm	6
T3203 022	22mm	12mm	6
T3203 025	25mm	12mm	6
T3203 032	32mm	12mm	6
T3203 038	38mm	12mm	6
T3203 040	40mm	12mm	6

Arbors & Accessories



Hole Enlarging Adaptor

Allows nesting of one holesaw inside another for concentric enlarging of existing holes. Double threaded to accept any size of holesaw.

Item No.		
T3216		6



Quick Change Arbor

Rapid Release System: Enables fast and tool free holesaw changeover. Universal Fitting: Compatible with most brands of holesaws. Suitable for holesaws from: 16 - 152mm.

Item No.	i	
T3224	Set	10
T3225	3 x <30mm adaptor	25
T3225 2	3 x >32mm adaptor	25



Locking Holesaw Arbor

For use with holesaws from 32mm - 152mm. Supplied with replaceable 1/4" HSS pilot drill.

Item No.		
424040	11mm (7/16")	10



Quick Release SDS+ Arbor

Quick-release mechanism for fast holesaw interchange. For use with holesaws from 32 - 152mm. Fixing pins are spring loaded for easy withdrawal making holesaw changes fast and efficient. SDS-Plus drive shaft. With replaceable 1/4" HSS pilot drill.

Item No.		i	
424048	11mm (7/16")	SDS-Plus	10



Quick Release Arbor

Quick-release mechanism for fast holesaw interchange. For use with holesaws from 32 - 152mm. Fixing pins are spring loaded for easy withdrawal making holesaw changes fast and efficient. 11mm hexagonal drive shaft. With replaceable 1/4" HSS pilot drill.

Item No.		
424039	11mm (7/16")	10



SDS+ Holesaw Arbor

For use with holesaws up to 30mm. Supplied with replaceable 1/4" HSS pilot drill. SDS Plus drive shaft.

Item No.		i	
424047	8mm (5/16")	SDS-Plus	10



Holesaw Arbor

For use with holesaws up to 30mm. Supplied with replaceable 1/4" HSS pilot drill.

Item No.		
424037	8mm (5/16")	10
424038	11mm (7/16")	10



Replacement Arbor Pilot Bit

Replacement HSS pilot drill bit for holesaw arbors.

Item No.	i	
424041	424037, 424047 & 424048	10
424042	424038, 424039, 424040, T3214 & T3224	10



Holesaw Extension Bar

For use with all 11mm hexagonal shaft arbors.

Item No.			
424049	11mm (7/16")	300mm	10

Impact screwdriver bits

1. Manufactured from specially formulated V8 steel alloy for extreme toughness.
2. Featuring torsion control technology to withstand the stresses of high torque applications.
3. C.K. Blue Steel Impact Bits provide a vastly extended working life.



Torsion Control Technology.



Blue Steel Impact Bits



Blue Steel Impact Bits - PZ 25mm

Item No.	✚	↔	i	📦
T4560 PZ1	PZ1	25mm	Loose	10
T4560 PZ2	PZ2	25mm	Loose	10
T4560 PZ3	PZ3	25mm	Loose	10
T4560 PZ1D	PZ1	25mm	Triple Pack	20
T4560 PZ2D	PZ2	25mm	Triple Pack	20
T4560 PZ3D	PZ3	25mm	Triple Pack	20



Blue Steel Impact Bits - PZ 50mm

Item No.	✚	↔	i	📦
T4560 PZ1L	PZ1	50mm	Loose	10
T4560 PZ2L	PZ2	50mm	Loose	10
T4560 PZ1LD	PZ1	50mm	Triple Pack	20
T4560 PZ2LD	PZ2	50mm	Triple Pack	20
T4560 PZ3LD	PZ3	50mm	Triple Pack	20



Blue Steel Impact Bits - PH 25mm

Item No.				
T4560 PH1	PH1	25mm	Loose	10
T4560 PH2	PH2	25mm	Loose	10
T4560 PH3	PH3	25mm	Loose	10
T4560 PH2D	PH2	25mm	Triple Pack	20
T4560 PH2D15	PH2	25mm	Set of 15	12



Blue Steel Impact Bits - PH 50mm

Item No.				
T4560 PH2L	PH2	50mm	Loose	10
T4560 PH2LD	PH2	50mm	Triple Pack	20
T4560 PH2LD10	PH3	50mm	Set of 10	12



Blue Steel Impact Bits - SL 25mm

Item No.				
T4560 SL45	4.5mm	25mm	Loose	10
T4560 SL55	5.5mm	25mm	Loose	10
T4560 SL65	6.5mm	25mm	Loose	10



Blue Steel Impact Bits - TX 25mm

Item No.				
T4560 TX05	TX05	25mm	Loose	10
T4560 TX06	TX06	25mm	Loose	10
T4560 TX07	TX07	25mm	Loose	10
T4560 TX08	TX08	25mm	Loose	10
T4560 TX09	TX09	25mm	Loose	10
T4560 TX10	TX10	25mm	Loose	10
T4560 TX15	TX15	25mm	Loose	10
T4560 TX20	TX20	25mm	Loose	10
T4560 TX25	TX25	25mm	Loose	10
T4560 TX27	TX27	25mm	Loose	10
T4560 TX30	TX30	25mm	Loose	10
T4560 TX40	TX40	25mm	Loose	10
T4560 TX30D15	TX30	25mm	Set of 15	12



Blue Steel Impact Bits - TX Tamperproof

Item No.				
T4560 TXTP10	TX10	25mm	Loose	10
T4560 TXTP15	TX15	25mm	Loose	10
T4560 TXTP20	TX20	25mm	Loose	10
T4560 TXTP25	TX25	25mm	Loose	10
T4560 TXTP30	TX30	25mm	Loose	10



Blue Steel Impact Bits - Hex

Item No.	Ø	↔	i	📦
T4560 HEX25	2.5mm	25mm	Loose	10
T4560 HEX30	3.0mm	25mm	Loose	10
T4560 HEX40	4.0mm	25mm	Loose	10
T4560 HEX50	5.0mm	25mm	Loose	10
T4560 HEX60	6.0mm	25mm	Loose	10



Blue Steel Impact Bits - Robertson

Item No.	Ø	↔	i	📦
T4560 ROB1	ROB1	25mm	Loose	10
T4560 ROB2	ROB2	25mm	Loose	10
T4560 ROB3	ROB3	25mm	Loose	10



Blue Steel Impact Bits Trade Pack

Item No.	✳	↔	i	📦
T4560 PZ2D15	PZ2	25mm	Set of 15	12
T4560 PZ3D15	PZ3	25mm	Set of 15	12
T4560 PZ2LD10	PZ2	50mm	Set of 10	12
T4560 PZ3LD10	PZ3	50mm	Set of 10	12



Blue Steel Impact Bits CBOX

Item No.	↔	i	📦
T4560 PZ2D15CS	W:220 x H:880 x D:115mm	Must be ordered in multiples of 12	12



Blue Steel Impact Bits Set/10 - PZ/PH

Item No.	i	↔	📦
T4510	Set of 10	25mm	20



Blue Steel Impact Bits Set/6 - PZ

Item No.	i	↔	📦
T4511	Set of 6	50mm	20



Blue Steel Impact Bits Set/6 - PH

Item No.	i	↔	📦
T4512	Set of 6	50mm	20



Blue Steel Impact Bits Set/6 - TX

Item No.	i	↔	📦
T4513	Set of 6	50mm	20

Screwdriver Bits



S2 Steel Modulo Bits

Premium quality chrome vanadium steel for exceptional strength & durability. Precision machined tip for an exact screw fit & damage free screwdriving. Drive: E6.3.

Item No.	⊕	↔	i	📦
T4545 1	MOD 1	50mm	Loose	20
T4545 2	MOD 2	50mm	Loose	20
422001	MOD 1 & 2	50mm	Card/2	10



Roofing Bolt Driver

Unique 4 blade design with optimised geometry for a perfect fit on roofing bolts. Stronghold magnet securely retains bolt for quicker alignment and fix. Impact rated S2 Steel with 6.35mm Hex Shank.

Item No.	↔	📦
T4561	75mm	6



Screwdriver Bits - PZ Long

Premium quality chrome vanadium steel. Precision machined for high performance screwdriving. Featuring grip tip anti cam out ribs - designed to positively engage with the screw head and reduce the risk of slip and cam out.

Item No.	↔	⊕	i	📦
T4556 1	50mm	PZ1	Loose	10
T4556-1T	50mm	PZ1	Card/2	25



Screwdriver Bits - PH Long

Premium quality chrome vanadium steel. Precision machined for high performance screwdriving. Featuring grip tip anti cam out ribs - designed to positively engage with the screw head and reduce the risk of slip and cam out.

Item No.	↔	⊕	i	📦
T4555 2	50mm	PH2	Loose	10



Screwdriver Bits - Slotted

Premium quality chrome vanadium steel. Precision machined for high performance screwdriving. Featuring grip tip anti cam out ribs - designed to positively engage with the screw head and reduce the risk of slip and cam out.

Item No.	↔	⊖	i	📦
T4550-0645T	25mm	0.6 x 4.5mm	Card/2	25
T4550 0855	25mm	0.8 x 5.5mm	Loose	10
T4550-0855T	25mm	0.8 x 5.5mm	Card/2	25
T4550-1055T	25mm	1.0 x 5.5mm	Card/2	25
T4550-1265T	25mm	1.2 x 6.5mm	Card/2	25



Screwdriver Bits - Torx

Premium quality chrome vanadium steel. Precision machined for high performance screwdriving.

Item No.	←→	⊕	i	📦
T4557 05	25mm	TX05	Loose	10
T4557 07	25mm	TX07	Loose	10
T4557 08	25mm	TX08	Loose	10
T4557 09	25mm	TX09	Loose	10
T4557 40	25mm	TX40	Loose	10
T4557-05T	25mm	TX05	Card/2	25
T4557-06T	25mm	TX06	Card/2	25
T4557-07T	25mm	TX07	Card/2	25
T4557-08T	25mm	TX08	Card/2	25
T4557-09T	25mm	TX09	Card/2	25
T4557-10T	25mm	TX10	Card/2	25
T4557-15T	25mm	TX15	Card/2	25
T4557T 15	25mm	TX15	Tamperproof - Loose	10
T4557T 20	25mm	TX20	Tamperproof - Loose	10
T4557T 30	25mm	TX30	Tamperproof - Loose	10
T4557T-15T	25mm	TX15	Tamperproof - Card/2	25



Screwdriver Bits - Hex

Premium quality chrome vanadium steel. Precision machined for high performance screwdriving.

Item No.	←→	○	i	📦
T4554-3T	25mm	3.0mm	Card/2	25
T4554-4T	25mm	4.0mm	Card/2	25
T4554-5T	25mm	5.0mm	Card/2	25
T4554-6T	25mm	6.0mm	Card/2	25



TiN Screwdriver Bits - PZ Long

Premium quality chrome vanadium steel, titanium nitride coated for the ultimate wear resistance. Precision machined for high performance screwdriving. Featuring grip tip anti cam out ribs - designed to positively engage with the screw head and reduce the risk of slip and cam out.

Item No.	←→	⊕	i	📦
T4556TIN-1T	50mm	PZ1	Card/2	20



TiN Screwdriver Bits - PH Long

Premium quality chrome vanadium steel, titanium nitride coated for the ultimate wear resistance. Precision machined for high performance screwdriving. Featuring grip tip anti cam out ribs - designed to positively engage with the screw head and reduce the risk of slip and cam out.

Item No.	←→	⊕	i	📦
T4555TIN 1T	50mm	PH1	Card/2	20



TiN Double Ended Bits - PH/Slotted

Premium quality chrome vanadium steel, titanium nitride coated for the ultimate wear resistance. Precision machined for high performance screwdriving. Featuring grip tip anti cam out ribs - designed to positively engage with the screw head and reduce the risk of slip and cam out.

Item No.	←→	⊕	⊕	i	📦
T4580TIN-1T	50mm	PH1	4mm	Card/2	20
T4580TIN-2T	50mm	PH2	7mm	Card/2	20



TiN Screwdriver Bits - Torx

Premium quality chrome vanadium steel, titanium nitride coated for the ultimate wear resistance. Precision machined tip for an exact screw fit & damage free screwdriving.

Item No.	i	←→	i	📦
T4557TIN 10	TX10	25mm	Loose	300
T4557TIN 15	TX15	25mm	Loose	300
T4557TIN 20	TX20	25mm	Loose	300
T4557TIN 25	TX25	25mm	Loose	300
T4557TIN 30	TX30	25mm	Loose	300
T4557TIN 40	TX40	25mm	Loose	300
T4557TIN-10T	TX10	25mm	Card/2	20
T4557TIN-15T	TX15	25mm	Card/2	20
T4557TIN-40T	TX40	25mm	Card/2	20



Screwdriver Bit Clip Set/7 - PZ

Premium quality S2 alloy steel for exceptional strength & durability. Precision machined tip for an exact fit & damage free screwing. CONTENTS: 1 x PZ1 / 4 x PZ2 / 1 x PZ3 / 1 x bit holder.

Item No.	i		
T4517	Set of 7	25mm	12



Screwdriver Bit Clip Set/31

Premium quality S2 alloy steel for exceptional strength & durability. Precision machined tip for an exact fit & damage free screwing. CONTENTS: 1xPZ1 / 4xPZ2 / 1xPZ3 2xTX10 / 4xTX15 / 4xTX20 /2xTX25 / 2xTX30 / 1xTX40 1xPH1 / 2xPH2 1xSL4.0mm / 1xSL5.5mm / 1xSL6.5mm 1x hex 4.0mm / 1x hex 5.0mm / 1x hex 6.0mm 1 x bit holder.

Item No.	i		
T4502	Set of 31	25mm	6



Screwdriver Bit Clip Set/7 - PH

Premium quality S2 alloy steel for exceptional strength & durability. Precision machined tip for an exact fit & damage free screwing. CONTENTS: 1 x PH1 / 4 x PH2 / 1 x PH3 / 1 x bit holder.

Item No.	i		
T4518	Set of 7	25mm	12



Screwdriver Bit Box Set/7

Made from high quality chrome vanadium steel. Hardened and tempered for long performance. Precision machined tips for an exact screw fit & damage free screwdriving. CONTENTS: Screwdriver bit holder; Bits: Slotted, sizes: 5.5 & 6.5mm; Pozidriv, sizes: 1 & 2; Phillips, sizes: 1 & 2.

Item No.	i		
T4583C	Set of 7	25mm	5



Screwdriver Bit Clip Set/7 - TX

Premium quality S2 alloy steel for exceptional strength & durability. Precision machined tip for an exact fit & damage free screwing. CONTENTS: TX10, TX15, TX20, TX25, TX30, TX40 & bit holder.

Item No.	i		
T4501	Set of 7	25mm	12



TiN Screwdriver Bit Set/7 - PZ

Premium quality chrome vanadium steel, titanium nitride coated for the ultimate wear resistance. Precision machined tip for an exact screw fit & damage free screwdriving. CONTENTS: 1 x Bit holder, Bits: 1 x PZ 1 and PZ 3, 4 x PZ 2.

Item No.	i		
T4569TINC	Set of 7	25mm	20



Screwdriver Bits Set/8 - PZ/PH

Bits made from special S2 alloy steel. Precision machined tips for an exact screw fit & damage free screwdriving. CONTENTS: Pozidriv, sizes: 0, 1, 2 & 3; Phillips, sizes: 0, 1, 2 & 3.

Item No.	
T4522	6



Screwdriver Bits Set/8 - Hex

Bits made from special S2 alloy steel. Precision machined tips for an exact screw fit & damage free screwdriving. CONTENTS: 1.5, 2, 2.5, 3, 4, 5, 5.5 & 6mm.

Item No.	
T4524	6



Screwdriver Bits Set/8 - Slotted

Bits made from special S2 alloy steel. Precision machined tips for an exact screw fit & damage free screwdriving. CONTENTS: 3, 4, 4.5, 5, 5.5, 6, 7, 8 & 9mm.

Item No.	
T4521	6



Screwdriver Bits Set/8 - Hex Tamperproof

Bits made from special S2 alloy steel. Precision machined tips for an exact screw fit & damage free screwdriving. CONTENTS: 2, 2.5, 3, 4, 5, 5.5, 6 & 7mm.

Item No.	
T4528	6



Screwdriver Bits Set/8 - Torx

Bits made from special S2 alloy steel. Precision machined tips for an exact screw fit & damage free screwdriving. CONTENTS: TX 8, 10, 15, 20, 25, 27, 30 & 40.

Item No.	
T4523	6



Screwdriver Bits Set/8 - Torx Tamperproof

Bits made from special S2 alloy steel. Precision machined tips for an exact screw fit & damage free screwdriving. CONTENTS: TX 8, 10, 15, 20, 25, 27, 30 & 40.

Item No.	
T4527	6



Screwdriver Bits Set/33 - Mixed

Bits made from special S2 alloy steel. Precision machined tips for an exact screw fit & damage free screwdriving. CONTENTS: Screwdriver bit holder, bits, slotted, sizes: 3, 4, 4.5, 5, 5.5, 6, 7, 8 & 9mm; Pozidriv, sizes: 0, 1, 2 & 3; Phillips, sizes: 0, 1, 2, & 3; TX, sizes: 8, 10, 15, 20, 25, 27, 30 & 40; Hexagon, sizes: 1.5, 2, 2.5, 3, 4, 5, 5.5 & 6mm.

Item No.	
T4520	6



Screwdriver Bits Set/10 - Long

Bits made from special S2 alloy steel. Precision machined tips for an exact screw fit & damage free screwdriving. CONTENTS: Slotted: 4, 5 & 7mm; Pozidriv: 1, 2 & 3; Phillips: 1, 2 & 3; TX: 15 & 20.

Item No.		
T4525	100mm	6



Damaged Screw Removers

Designed for the fast removal of damaged non hardened screws. Hexagon shaft for use with reversible drill. Pack CONTENTS: two sizes for screws 6 - 10 & 12 - 14mm.

Item No.		
422003		12
T3060-CLIP	Clipstrip x 6	1
T3060-CBOX	Counterbox x 12	1



Screwdriver Bits Set/41

Premium quality S2 alloy steel for exceptional strength & durability. Precision machined tip for an exact fit & damage free screwing. CONTENTS: 2 x PH1, 4 x PH2, 2 x PH3, 4 x PZ1, 8 x PZ2, 4 x PZ3; 2 x 4.0mm, 2 x 5.5mm, 2 x 6.0mm, 2 x 8.0mm (slotted); 1 x TX15, 1 x TX20, 1 x TX25, 1 x TX30; 1 x 3.0mm, 1 x 4.0mm, 1 x 5.0mm, 1 x 6.0mm (hexagon); 1 x bit holder.

Item No.			
T4509	Set of 41	25mm	6



Screw Extractor Set/5

Hardened chrome vanadium steel. Left hand threaded for extracting broken studs and screws.

Item No.	
T3062 01	5



Security Bits Set/41

Premium quality S2 alloy steel for exceptional strength & durability. Precision machined tip for an exact fit & damage free screwing. In metal box for convenience. CONTENTS: Phillips: 1 x PH0 / 1 x PH1 / 3 x PH2 / 1 x PH, Pozidriv: 1 x PZ0 / 1 x PZ1 / 1 x PZ2 / 1 x PZ, Slotted: 1 x 4.0mm / 1 x 5.0mm / 1 x 6.0mm / 1 x 8.0mm, Multitooth: 1 x size 4 / 1 x size 5 / 1 x size 6 / 1 x size 8, Spanner: 1 x size 4 / 1 x size 6 / 1 x size 8 / 1 x size 10, Torque-Set: 1 x size 6 / 1 x size 8 / 1 x size 10, Tamper-TX: 1 x TX8 / 1 x TX10 / 1 x TX15 / 1 x TX20 / 1 x TX25 / 1 x TX27 / 1 x TX30 / 1 x TX40, Tri-Wing: 1 x size 1 / 1 x size 2 / 1 x size 3 / 1 x size, 1 x bit holder.

Item No.			
T4508	Set of 41	25mm	6



Screwdriver Bits CBOX - PZ

Premium quality chrome vanadium steel, titanium nitride coated for the ultimate wear resistance. Precision machined for high performance screwdriving. Featuring grip tip anti cam out ribs - designed to positively engage with the screw head and reduce the risk of slip and cam out.

Item No.			
T4562-2CB	25mm	PZ2	1



TiN Screwdriver Bits CBOX - PZ

Premium quality chrome vanadium steel, titanium nitride coated for the ultimate wear resistance. Precision machined for high performance screwdriving. Featuring grip tip anti cam out ribs - designed to positively engage with the screw head and reduce the risk of slip and cam out.

Item No.			
T4562TIN-215			10



SDS+ Bit Holder

Stainless steel - strong & corrosion resistant. Magnetic base for bit retention. SDS Plus drive.

DIN 7427

Item No.		
T4564SDSC	74mm	10



Locking Bit Holder

Locking mechanism securely retains bit in place. Quick release mechanism allows fast & convenient bit changes.

DIN 3126 E6.3 & ISO 1173

Item No.		
T4564D	60mm	10

Screwdriver Bit Holders



Nut Driver - Magnetic

For fast and effective driving of hex head screw fixings. Forged alloy steel for strength and durability. Colour coded for convenience.

DIN 3126 E6.3 & ISO 1173

Item No.			
T4598	8mm	Loose	10
T4598C 08	8mm	Carded	10



Screw Grip Magnetic Bit Holder

Magnetic base retains bit in place. Magnetic collar holds the screw in place.

DIN 3126 E6.3 & ISO 1173

Item No.		
T4567D	70mm	10



Magnetic Bit Holders

Strong & corrosion resistant stainless steel sleeve. Magnetic base and c-ring securely retains the bit in place.

DIN 3126 E6.3 & ISO 1173

Item No.		
T4570	60mm	10
T4570 100	100mm	10
T4570 200	200mm	10



Pivot Joint Bit Holder

Magnetic base securely retains the bit in place. Pivoting head for when straight line access isn't possible. Lockable collar for use as a straight line bit holder. E6.3 drive.

Item No.		
T4504	100mm	25



Keyless Chuck Adaptor

1/4" hexagon to 3 jaw chuck converter. E6.3 drive. Keyless chuck. Fits up to 6mm drill bits.

Item No.		
T2463	6mm	6

Multitool Blades



Multitool Blade - Box Cutter

Optimized curved teeth design for efficient cutting action. Integrated double-socket guide for quick alignment and cut. HCS construction for strength and durability. Universal quick change fitment covers most brands of oscillating tool (not compatible with Starlock). Multi-material: for use on plasterboard, wood and plastic.

Item No.		
T0880	75 x 75 x 32mm	1



Quick Change Chuck System

Bits made from special S2 alloy steel. Precision machined tips for an exact screw fit & damage free screwdriving. CONTENTS: Screwdriver bit holder, Quick change chuck, Slotted, sizes: 4, 5, 6, & 7mm; Pozidriv, sizes: 1, 2 & 3; Phillips, sizes: 1, 2 & 3; TX, sizes: 10, 15, 20, 25, 30 & 40; Hexagon, sizes: 3, 4, 5, & 6mm. 2 x drill/driver bits, sizes: 2.5mm x Pozidriv1 & 3.0mm x Pozidriv1 x drill/driver bit, size: 4.0mm x Pozidriv.

Item No.	
T4519	6



Multitool Blade - Carbide

Carbide Construction for extreme cutting performance. Cuts ferrous metals, hardened screws, bolts, nails, and abrasive materials. Universal quick change fitment covers most brands of oscillating tool (not compatible with Starlock).

Item No.		
T0877	34 x 40mm	10



Magnetic Nut Drivers Set/7

For fast and effective driving of hex head screw fixings. Forged alloy steel for strength and durability. Colour coded for convenience. CONTENTS: 7 / 8 / 10 / 11 / 13mm - 1/4" & 3/8". DIN 3126 E6.3 and ISO 1173

Item No.		
T4514	Set of 7	14



Multitool Blade - Scraper

Stainless steel construction for durability and easy cleaning. Removes grout glue, paint, tile and wall adhesives with ease. Universal quick change fitment covers most brands of oscillating tool (not compatible with Starlock).

Item No.		
T0878	52 x 38mm	10



Multitool Blade - 2 Piece Set

Strong and durable multitools to be used with a range of materials including; thin steel, wood, wood with nails, plastics and non ferrous metals.

Item No.		
T0875	34 x 40mm	1
T0876	28.5 x 57mm	1



Multitool Blade - 5 Piece Set

Strong and durable multitools to be used with a range of materials including; thin steel, wood, wood with nails, plastics and non ferrous metals. CONTENTS: 2 x 34mm x 40 wood HCS, 1 x 34mm x 40 BIM, 1 x 80mm diameter BIM, 1 x 65mm x 42 wood BIM M2 (Japanese teeth).

Item No.	
T0870	1

Jigsaw Blades



Straight Cut Blade - Metal

Thin metal, straight cuts.

Item No.				BOSCH	
T0865A	50mm	2.5mm	1.5 - 3mm	T118A	5



Coarse Cut Blade - Wood

Wood, fast coarse cuts.

Item No.				BOSCH	
T0865B	75mm	2.5mm	5 - 60mm	T111C	5



Fine Cut Blade - Wood

Wood, precise cuts.

Item No.				BOSCH	
T0865C	75mm	2.5mm	4 - 30mm	T101B	5



Straight Cut Blade - Thick Metal

Thicker metal, straight cuts.

Item No.				BOSCH	
T0865H	50mm	1.2mm	3 - 60mm	T118B	5



Fast Cut Blade - Wood

Wood, fast clean cuts.

Item No.				BOSCH	
T0865L	75mm	4mm	6 - 60mm	T101D	5



Fast Fine Cut Blade - Wood

Wood, fast extra clean cuts.

Item No.				
T0865P	95mm	4mm	8 - 75mm	5



Fine Cut Blade - Metal

Metal & sandwich materials.

Item No.				BOSCH	
T0865Y	110mm	1.2mm	1.5 - 3mm	T318A	5



Down Cut Blade - Laminate

Wood laminates, down cut.

Item No.				BOSCH	
T0865R	75mm	2.5mm	4 - 30mm	T101BR	5

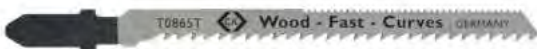

Curved Cut Blade - Wood

Wood, extra clean curved cuts.

Item No.				BOSCH	
T0865T	75mm	2.5mm	4 - 30mm	T244D	5



Straight Cut Blade - Universal

Universal. For straight cuts in soft & hardwood, wood with nails, steel, aluminium, laminate, plastics and particle board.

Item No.				
T0865W	110mm	1.8-2.5mm	3 - 100mm	5



Double Cut Blade - Wood

Wood, fast double cut.

Item No.				
T0865X	75mm	2.0mm	3 - 60mm	5

Reciprocating Blades



Reciprocating Saw Blades

Multi-purpose reciprocating saw blades cut metal, wood, plastic and plasterboard. Universal fitting - Compatible with T0820 and all reciprocating saws.

Item No.					
T0821	150mm	6	HCS	Set of 5	10
T0822	150mm	18	BIM	Set of 5	10
T0823	150mm	24	BIM	Set of 5	10



Building & Decorating

Bricklaying	132
Plastering	133
Trowels	134
Tiling & Glazing	136
Paddles & Mixers	137
Scrapers & Filling Knives	137
Plumbing	138
Glue Guns	138
Staple Guns	139
Bradawls	139

Bricklaying



Broad Heel Brick Trowel - Soft Grip

High carbon steel blade. Hardened & taper ground for the optimum balance of strength & flexibility. Heavy duty tang welded to blade for strength & durability. Patented soft grip handle with finger guard for comfort & control.

Item No.	←————→	
T529510	255mm (10")	3



Philadelphia Brick Trowel - Wood Handle

High carbon steel blade. Hardened & taper ground for the optimum balance of strength & flexibility. Heavy duty tang welded to blade for strength & durability. Traditional wooden handle.

Item No.	←————→	
T527111	275mm (11")	1



Philadelphia Brick Trowel - Soft Grip

High carbon steel blade. Hardened & taper ground for the optimum balance of strength & flexibility. Heavy duty tang welded to blade for strength & durability. Patented soft grip handle with finger guard for comfort & control.

Item No.	←————→	
T529311	280mm (11")	3



Philadelphia Brick Trowel - Stainless Steel

Stainless steel blade for corrosion protection & low maintenance. Heavy duty tang welded to blade for strength & durability. Patented soft grip handle with finger guard for comfort & control.

Item No.	←————→	
T524111	280mm (11")	3



Broad Heel Brick Trowel - Wood Handle

High carbon steel blade. Hardened & taper ground for the optimum balance of strength & flexibility. Heavy duty tang welded to blade for strength & durability. Traditional wooden handle.

Item No.	←————→	
T527010	250mm (10")	6
T527011	275mm (11")	3



Brick Jointer

Fully hardened & tempered carbon steel for wear resistance.

Item No.	←————→	
T5198	13 x 16mm (1/2 x 5/8")	12

Plastering



Finishing Trowel - Soft Grip

High carbon steel blade, hardened & tempered for the optimum balance of strength & flexibility. Welded & riveted tang to blade joint for outstanding durability. Soft grip handle for comfort & control.

Item No.		
T5298	280 x 120mm (11 x 4 3/4")	6



Plasterers Hawk

Lightweight aluminium blade with grooved, non-slip surface.

Item No.		
T5069	300 x 300mm (12 x 12")	3



Finishing Trowel - Wood Handle

High carbon steel blade, hardened & tempered for the optimum balance of strength & flexibility. Welded & riveted tang to blade joint for outstanding durability. Traditional wooden handle.

Item No.		
T5068	280 x 120mm (11 x 4 3/4")	6



Leaf & Square Tool

Solid forged steel blade, hardened, tempered & ground for the optimum balance of flexibility & strength.

Item No.			
T5091 50	200mm (8")	12mm (1/2")	3



Skimmer Floats

Lightweight, moulded foam polymer with fine chequered working face - durable & non-warping.

Item No.		
T5172	280 x 140mm	1
T5172 18	320 x 180mm	1



Trowel & Square Tools

Solid forged steel blade, hardened, tempered & ground for the optimum balance of flexibility & strength.

Item No.			
T5093 50	265mm (10 1/2")	12mm (1/2")	3
T5093 62	265mm (10 1/2")	16mm (5/8")	3
T5093 75	265mm (10 1/2")	19mm (3/4")	3

Trowels



Pointing Trowel - Soft Grip

High carbon steel blade. Hardened & taper ground for the optimum balance of strength & flexibility. Heavy duty tang welded to blade for strength & durability. Patented soft grip handle with finger guard for comfort & control.

Item No.		
T529606	150mm (6")	3



Gauging Trowel - Soft Grip

High carbon steel blade. Hardened & taper ground for the optimum balance of strength & flexibility. Heavy duty tang welded to blade for strength & durability. Patented soft grip handle with finger guard for comfort & control.

Item No.		
T529207	180mm (7")	6



Finger Trowel - Soft Grip

High carbon steel blade. Hardened & taper ground for the optimum balance of strength & flexibility. Heavy duty tang welded to blade for strength & durability. Patented soft grip handle with finger guard for comfort & control.

Item No.		
T529750	175 x 13mm (7 x 1/2")	3



Pointing Trowels - Wood Handle

High carbon steel blade. Hardened & taper ground for the optimum balance of strength & flexibility. Heavy duty tang welded to blade for strength & durability. Traditional wooden handle.

Item No.		
T5060 4	100mm (4")	3
T5060 5	125mm (5")	3
T5060 6	150mm (6")	6



Gauging Trowel - Wood Handle

High carbon steel blade. Hardened & taper ground for the optimum balance of strength & flexibility. Heavy duty tang welded to blade for strength & durability. Traditional wooden handle.

Item No.		
T527207	175mm (7")	3



Finger Trowels - Wood Handle

High carbon steel blade. Hardened & taper ground for the optimum balance of strength & flexibility. Heavy duty tang welded to blade for strength & durability. Traditional wooden handle.

Item No.			
T5073 1	175mm (7")	13mm (1/2")	3
T5073 37	175mm (7")	10mm (3/8")	3
T5073 50	175mm (7")	13mm (1/2")	3
T5073 62	175mm (7")	16mm (5/8")	3
T5073 75	175mm (7")	19mm (3/4")	3
T5073 99	175mm (7")	25mm (1")	3



Margin Trowel

High carbon steel blade. Hardened & taper ground for the optimum balance of strength & flexibility. Heavy duty tang welded to blade for strength & durability. Traditional wooden handle.

Item No.		
T5273	125mm (5")	3



Harling Trowel

Heavy gauge steel blade with tang welded to blade for strength & durability. Traditional wooden handle.

Item No.		
T5097	165 x 165mm (6 1/2 x 6 1/2")	2



Flooring Trowel

High carbon steel blade. Hardened & tempered for the optimum balance of strength & flexibility. Welded & riveted tang to blade joint for outstanding durability. Traditional wooden handle.

Item No.		
T5264	405 x 115mm (16 x 4 1/2")	3



Pointing Trowel - Stainless Steel

Stainless steel blade for corrosion protection & low maintenance. Heavy duty tang welded to blade for strength & durability. Patented soft grip handle with finger guard for comfort & control.

Item No.		
T524306	150mm (6")	6



Edging Trowel

High carbon steel blade. Hardened & taper ground for the optimum balance of strength & flexibility. Heavy duty tang welded to blade for strength & durability. Traditional wooden handle.

Item No.		
T5274	280 x 115mm (11 x 4 1/2")	3



Gauging Trowel - Stainless Steel

Stainless steel blade for corrosion protection & low maintenance. Heavy duty tang welded to blade for strength & durability. Patented soft grip handle with finger guard for comfort & control.

Item No.		
T524207	175mm (7")	3

Tiling & Glazing



Tile Scriber

Tungsten carbide tipped, suitable for tiles, metal and glass. Pocket clip.

Item No.		
T1531		12



Adhesive Trowels

Polished carbon steel blade. Comfortable soft grip handle.

Item No.		
T5170 1	280 x 115 x 20mm (11 x 4 1/2 x 3/4")	6
T5170 2	280 x 115 x 6mm (11 x 4 1/2 x 1/4")	6



Grouting Sponge

Lightweight, polymer handle bonded to a sponge pad - suitable for washing down grout.

Item No.		
T5173	280 x 140mm (11 x 5 1/2")	1



Grouting Float

Lightweight, polymer handle bonded to a dense rubber pad - suitable for grout application.

Item No.		
T5174	280 x 140mm (11 x 5 1/2")	1



Glass Cutter

High quality with 6 premium quality tungsten carbide blades in turret head. Oiled felt washer for constant lubrication. Heavy nickel plated head for protection.

Item No.		
T5087		6

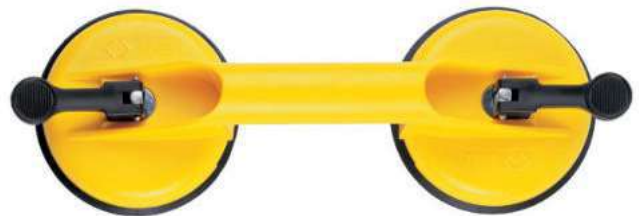

Suction Lifter - 60kg

Lever action, double suction cup designed to lift up to 60Kg. Heavy duty construction for strength & durability.

Item No.			
T5082	320mm (12 3/4")	60kg	1

Paddles & Mixers



Power Paint Mixer

Nickel plated steel construction for strength & easy cleaning. Suitable for use with electric drills at speeds between 200 - 700rpm.



Item No.		
T1881	420mm (16 1/2")	2
T1882	620mm (25")	2

Scrapers & Filling Knives



Scrapers / Filling Knives



Tapered ground spring steel blade for strength & flexibility. Plastic wipe clean handles with hanging hole for convenient storage.

Item No.		
T5070A 040	40mm (1 1/2")	6
T5070A 050	50mm (2")	6
T5070A 070	70mm (2 3/4")	6
T5070A 100	100mm (4")	6



Scrapers

High quality, taper ground spring steel blade for strength. Walnut handle.

Item No.		
T5075 1	25mm (1")	3
T5075 2	50mm (2")	3
T5075 3	75mm (3")	3
T5075 4	100mm (4")	3



Filling Knife

High quality, thin, taper ground spring steel blade for the optimum balance of strength & flexibility required for filling. Rosewood handle.

Item No.		
T5077 3	75mm (3")	6



Putty Knife

High quality spring steel blade for strength & flexibility. Clip point profile for smoothing & shaping putty. Rosewood handle.

Item No.	
T5076	1

Plumbing



Basin Wrench

Adjustable, telescopic wrench with sliding T handle for confined & long reach access. Spring loaded, self adjusting jaws maintain an automatic grip. 180° swivelling head for clockwise or anti-clockwise action. Hardened steel jaws for durability.

Item No.		
T4311	275 - 460mm	6



Immersion Heater Spanner

One piece steel construction for strength & durability. Zinc plated for corrosion protection. PVC handle for comfort and grip.

Item No.		
T4347	85mm	6



Stillson Wrench

High quality drop forged steel construction with hardened & tempered jaws for strength & durability. Patented head design for high torque performance. Non slip, durable paint finish for grip and control.

Item No.			
T3735 300	300mm (12")	38mm	8
T3735 350	350mm (14")	55mm	8
T3735 450	450mm (18")	55mm	8
T3735 600	600mm (24")	70mm	4

Glue Guns



Glue Gun

Premium quality with high energy heater for fast heating & improved glue flow. Heat insulated nozzle for safety. Integral wire stand for convenience. Glue output of up to 21g/min for fast application. Supplied with two 100 x 11mm general purpose glue sticks.

LDV, RoHS, WEEE

Item No.		
T6215	UK 3 pin plug	6
T6215A	Euro 2 pin plug	6



Glue Gun Kit

Premium quality with high energy heater for fast heating & improved glue flow. Heat insulated nozzle for safety. Integral wire stand. Glue output of up to 21g/min for fast application. CONTENTS: Glue gun, 12 x glue sticks, size: 200mm.



LDV, RoHS, WEEE

Item No.		
T6216	Euro 2 pin plug	1



Glue Sticks



10g Glue Sticks. Diameter: 11mm. Colour: transparent.

Item No.			
T6218 06	100mm	x 6	6
T6218 25	100mm	x 25	6
T6219 025	200mm	x 25	1
T6219 125	200mm	x 125	1



Staples - Square

High quality steel staples, galvanised for corrosion protection - to suit C.K 496001 heavy duty staple gun.

Item No.		
496002	10.5 x 8mm	10
496003	10.5 x 10mm	10
496004	10.5 x 12mm	10
496005	10.5 x 14mm	10

Staple Guns



Staple & Nail Gun

Heavy duty, tough cast aluminium body for strength & durability. Bi-material ergonomic handle for comfort & reduced fatigue. Unique staple loading & clearing mechanism for fast & convenient use. Handle safety locking system prevents accidental operation. Fires staples 6-14mm (interchangeable with Arrow T50 or Rapid 140 6-14mm) & nails (brads) 18 gauge 16mm. Supplied with 200 x 8mm staples.



Item No.	
496001	3

Bradawls



Bradawl - Square

Hardened steel square spike bradawl with lacquered beech handle and solid brass ferrule.

Item No.			
T4831 2	100mm (4")	85mm (3 1/4")	6



Bradawl - Round

Nickel plated hardened steel blade for a long life. Shatterproof ball ended acetate handle for comfort and safety.

Item No.				
T4835	6mm (1/4")	100mm (4")	85mm (3 1/4")	6



C.K.

4229 16oz

Striking Tools

Hammers	142
Wrecking Tools	144
Chisels	144
Punches	145

Hammers



Claw Hammers - Anti-Vibration One Piece

Single piece drop forged high carbon steel head & shaft - hardened & tempered for superior strength & durability. Balanced weight design with energy saving claw geometry for improved performance. Contoured anti-vibe shock absorbing grip system to protect against injury through shock. Polished & lacquered to protect against corrosion.

Item No.	Weight	Quantity
357001	454g (16oz)	6
357002	568g (20oz)	6



Claw Hammers - Hi-Vis

Drop forged high carbon steel head - hardened & tempered for superior strength and durability. Tubular steel shaft - strong & lightweight. Hi-vis handle for increased visibility in low light conditions. Black lacquered to protect against corrosion.

Item No.	Weight	Quantity
T4229 08	227g (8oz)	6
T4229 16	454g (16oz)	6
T4229 20	568g (20oz)	6



Engineers Hammer - German Pattern

Drop forged high carbon steel head - hardened & tempered for superior strength and durability. Black lacquered to protect against corrosion. Traditional ash shaft for strength.

Item No.	Weight	Quantity
T4227A 0100	100g (3 1/2oz)	12
T4227A 0200	200g (7oz)	12
T4227A 0300	300g (10 1/2oz)	12
T4227A 0500	500g (17 1/2oz)	12
T4227A 1000	1000g (35oz)	6



Claw Hammers - Anti-Vibration Fibreglass

Drop forged high carbon steel head - hardened & tempered for superior strength and durability. Tough fibreglass shaft for strength. Contoured anti-vibe shock absorbing grip system to protect against injury from transmitted shock. Polished and lacquered to protect against corrosion.

Item No.	Weight	Quantity
357003	454g (16oz)	6
357004	568g (20oz)	6



Club Hammer - Anti-Vibration One Piece

Single piece drop forged high carbon steel head & shaft - hardened & tempered for superior strength and durability. Contoured anti-vibe shock absorbing grip system to protect against injury from transmitted shock. Polished and lacquered to protect against corrosion.

Item No.	Weight	Quantity
357005	1361g (3lb)	2



Engineers Hammer - French Pattern

Drop forged high carbon steel head - hardened & tempered for superior strength and durability. Black lacquered to protect against corrosion. Traditional ash shaft for strength.

Item No.	Weight	Quantity
356002	300g (10 1/2oz)	12
356003	400g (14oz)	12



Electricians Hammer - French Pattern

Drop forged high carbon steel head - hardened & tempered for superior strength and durability. Black lacquered to protect against corrosion. Traditional ash shaft for strength.

Item No.	Weight	Quantity
356001	200g (7oz)	12



Pin Hammer

Drop forged high carbon steel head - hardened & tempered for superior strength and durability. Black lacquered to protect against corrosion. Tough hickory shaft for durability. Cross pein for easy starting of small nails & pins.

Item No.	Weight	Quantity
T4203	114g (4oz)	3



Club Hammers

Drop forged high carbon steel head - hardened & tempered for superior strength and durability. Black lacquered to protect against corrosion. Tough hickory shaft to withstand high impact applications.

Item No.	Weight	Quantity
T4219 40	1135g (2 ½lb)	2
T4219 64	1816g (4lb)	2
T4219A 10	1000g (2 ¼lb)	6
T4219A 15	1500g (3 ½lb)	6



Brick Hammers

Drop forged high carbon steel head - hardened & tempered for superior strength and durability. Accurately ground chisel end for clean cutting. Tubular steel shaft - strong & lightweight.

Item No.	Weight	Quantity
T4232 16	454g (16oz)	4
T4232 20	568g (20oz)	4



Mortar Pick

Drop forged high carbon steel head - hardened & tempered for superior strength and durability. Tubular steel shaft - strong & lightweight.

Item No.	Description	Quantity
T4234	Chisel and point	6



Ball Pein Hammer

Drop forged high carbon steel head - hardened & tempered for superior strength and durability. Black lacquered to protect against corrosion. Tough hickory shaft for durability. Ball pein for setting rivets.

Item No.	Weight	Quantity
T4208H 16	454g (1lb)	3



Joiners Hammer

Drop forged high carbon steel head - hardened & tempered for superior strength and durability. Black lacquered to protect against corrosion. Tough hickory shaft for durability. Cross pein for easy starting of small nails & pins.

Item No.	Weight	Quantity
T4204 08	227g (8oz)	3

Wrecking Tools



Japanese Prybar

Hot forged from carbon steel alloy, hardened for strength and durability. 46mm wide tip for precise removal with minimal damage. Flat heel for striking with a hammer.

Item No.		
T4312	10"	10



Prybar, Nail Puller & Scraper

Forged spring steel for strength and durability. Specially contoured & notched for efficient nail pulling and prying. Sharp angle ground ends for effective chiselling & scraping.

Item No.		
T4310	380mm (15")	6

Chisels



Slaters Ripper

Single piece forged spring steel construction for strength & durability. Slim blade design with double sided hooked blades for fast & effective nail cutting.

Item No.	
T5180	1



Brick Bolster Chisels with Grip

Hand guard for increased comfort & protection from overstrike.
BS 3066

Item No.			
T3087S 3	230mm (9")	75mm (3")	10
T3087S 4	230mm (9")	100mm (4")	10



Brick Bolster Chisels

Octagonal shank brick bolster with precision ground cutting edges. Specifically designed for cutting bricks and composite blocks. Powder coated for corrosion protection.
BS 3066

Item No.			
T3087 3	230mm (9")	75mm (3")	10
T3087 4	230mm (9")	100mm (4")	10



Electricians Bolster with Grip

Hand guard for increased comfort & protection from overstrike.
BS 3066

Item No.			
T3086S	225mm (8 3/4")	55mm (2 1/4")	10



Electricians Bolster Chisel

Octagonal shank electrician's bolster with precision ground cutting edges for long term performance. Ideal for splitting and lifting floorboards, cutting plaster and chasing. Powder coated for corrosion protection.
BS 3066

Item No.			
T3086	225mm (8 3/4")	55mm (2 1/4")	10



Plugging Chisel

Angled & grooved cutting edge for the effective removal of mortar & cement.

BS 3066

Item No.			
T3088	250mm (10")	25mm (1")	10



Cold Chisels

Chisel for cutting small section steel, can also be used on brick and concrete. Hardened steel with powder coating for corrosion protection. Hexagon shaft.

BS 3066

Item No.			
T3383 06	150mm (6")	12mm (1/2")	10
T3383 07	180mm (7")	16mm (5/8")	10
T3383 08	200mm (8")	19mm (3/4")	10
T3383 10	250mm (10")	19mm (3/4")	10
T3383 18	460mm (18")	19mm (3/4")	10
T3383 101	250mm (10")	25mm (1")	10
T3383 12	300mm (12")	25mm (1")	10



Scutch Chisels

High quality carbon steel, hardened & tempered for strength & durability. Replaceable chisel bits.

BS 3066

Item No.		
406001	25mm (1")	3
406002	38mm (1 1/2")	3



Scutch Chisel - Spare Bits

10 spare comb bits for scutch chisels.

Item No.			
T4211/1	25mm (1")	Scutch combs	10
T4211/2	25mm (1")	Scutch drives	10
T4211/3	38mm (1 1/2")	Scutch combs	10
T4211/4	38mm (1 1/2")	Scutch drives	10



Bolster Chisels - Stocked CDU

CONTENTS: 7 x plugging chisels, 7 x electrician's bolster chisels, 6 x bolster chisels, sizes: 75 & 100mm, 3 x bolster chisels with grip, size: 100mm.

Item No.		
T3090LS	Stock & stand	1

Punches



Plasterboard Punch

Stepped, special alloy shaft for punching 5, 6 & 7mm wall plug holes - no drilling, no mess. Cone point for punching, scribing and marking plasterboard. Shatterproof acetate handle with a strike-through cap - withstands hammer blows.

Item No.			
T4837	98mm	100mm	6



Centre Punches

High quality chrome vanadium steel hardened for durability.

Item No.		
T3319	150mm (6")	6
T3326	120mm (4 3/4")	6



Pin Punches

High quality chrome molybdenum steel hardened for durability. DIN 645

Item No.			
T3328 05	150mm (6")	2mm (5/64")	6
T3328 06	150mm (6")	2.5mm (3/32")	6
T3328 08	150mm (6")	3mm (1/8")	6
T3328 10	150mm (6")	4mm (5/32")	6
T3328 12	150mm (6")	5mm (3/16")	6
T3328 14	150mm (6")	5.5mm (7/32")	6
T3328 16	150mm (6")	6mm (1/4")	6
T3328 20	150mm (6")	8mm (5/16")	6
T3328 24	150mm (6")	10mm (3/8")	6
T3328S	2, 2.5, 3, 4, 5 & 6mm		3



Sawing, Cutting & Filing

Wood Saws	148
Hacksaws	149
Multisaws	150
Plasterboard Saws	150
Trimming Knives	151
Files & Rasps	152
Wood Chisels	155

Wood saws

1. The Sabretooth saw range offers the comfort speed and durability typically only associated with premium priced saws.
2. Featuring triple ground 'turbo cut' hard point teeth for effective cutting of timber, chipboard, plywood and plastics.







Wood Saws



Sabretooth Trade Universal Wood Saw

Universal tooth pitch for a wide range of materials. Offset teeth for reduced friction & greater waste removal. 0.85mm premium grade CK5 steel blade for maximum power transfer. 45 & 90° angle guides for ease of marking out. Dual component cushion grip handle for comfort and control. Stay sharp, hard point teeth for an extended working life.

Item No.				
T0840 20	20"	7 TPI / 8 PPI	Supplied in a counterbox when ordered in 10's	10
T0840 22	22"	7 TPI / 8 PPI	Supplied in a counterbox when ordered in 10's	10



Sabretooth Trade Fine Cut Wood Saw

Universal tooth pitch for a wide range of materials. Offset teeth for reduced friction & greater waste removal. 0.85mm premium grade CK5 steel blade for maximum power transfer. 45 & 90° angle guides for ease of marking out. Dual component cushion grip handle for comfort and control. Stay sharp, hard point teeth for an extended working life.

Item No.				
			Supplied in a	



Sabretooth Wood Saw

Triple edge, ultra sharp diamond ground teeth that cut on both the push and the pull. Up to 41% fewer strokes, saving time and effort. Easy start tooth configuration for clean and accurate cut starts. Induction hardened teeth for outstanding wear resistance. Rigid 1mm thick blade made from premium quality alloy steel for non flex and perfect straight cuts. Ergonomic handle design featuring a soft grip insert for comfort and control plus 45/90° marking bevels.

Item Number			
481001	22"	7 TPI / 8 PPI 1st fix	10
481002	22"	11 TPI / 12 PPI 2nd fix	10

Hacksaws



Quick Change Hacksaw

Quick release mechanism for rapid blade change. Ergonomic front and rear soft grip handles for extra comfort. Supplied with a 300mm (12") 24TPI Bi-metal blade. Balanced and durable heavy duty frame. Additional 55° blade fixed mounting pins for flush cutting.

Item No.		tpi	
T0815	300mm (12")	24 TPI	5



Heavy Duty Quick Change Hacksaw

Heavy duty premium quality hacksaw with rubber grips for comfort & control. Quick release blade change mechanism for convenience. High leverage blade tensioning system for straighter cuts. Spare blade storage in back frame for convenience. 45 & 90° blade positions.

Item No.		tpi	
T0814	300mm (12")	24 TPI	3



Technicians Hacksaw

High tension blade mechanism for rapid cutting. Ergonomically designed soft grip handles for extra comfort. Supplied with a 300mm (12") 24TPI Bi-metal blade. Balanced and durable, coated aluminium frame with blade storage. Additional 55° blade fixed mounting pins for flush cutting.

Item No.		tpi	
T0816	300mm (12")	24 TPI	5



Heavy Duty Hacksaw

Heavy duty, box section steel frame with aluminium handle for strength & durability. High leverage blade tensioning system for straighter cuts. Spare blade storage in back frame for convenience. 45 & 90° blade positions.

Item No.		tpi	
T0905	300mm (12")	24	3



Heavy Duty Ripping Saw

Optimized design to easily access nails underneath slates and tiles. Less damage to roof coverings and joinery. 14 TPI precision power blade for exceptional durability and cutting performance. Ergonomic handle for comfortable one-handed use. Reversible blade for extended working life.

Item No.		tpi	
T0817	600mm (24")	14 TPI	5



Hacksaw Blades

Shatterproof HSS Bi-metal construction.

Item No.		tpi	i	
T0932R 1218	300mm (12")	18 tpi	Pack of 3	12
T0931R 12	300mm (12")	24 tpi	Pack of 3	12
T0934R 1232	300mm (12")	32 tpi	Pack of 3	12
T0932 12	300mm (12")	18 tpi	Pack of 25	10
T0933 12	300mm (12")	24 tpi	Pack of 25	10
T0934 12	300mm (12")	32 tpi	Pack of 25	10



Mini Hacksaw

Cast aluminium frame for strength. Broad handle for comfort. Adjustable blade for angled cutting. Special screw tensioner for fast & simple blade fitting.

Item No.	Length	Quantity
T0836A	150mm (6")	6



Mini Hacksaw & Mitre Box

Cast aluminium frame for strength. Broad handle for comfort. Adjustable blade for angled cutting. Special screw tensioner for fast & simple blade fitting. Supplied with lightweight 3 angle mitre box.

Item No.	Length	Quantity
T0837	150mm (6")	5



Junior Hacksaw

Non protruding blade fixing for safety.

Item No.	Length	Quantity
T0834	150mm (6")	6



Junior Hacksaw Blades

Pack of 10 blades of 150mm length.

Item No.	Length	Quantity	Quantity
T0835	150mm (6")	x 10	10

Multisaws



Multi-Saw

Multi-purpose saw cuts metal, wood, plastic and plasterboard. Quick release mechanism for rapid blade change. Universal fitting - Compatible with all standard hacksaw, jigsaw and reciprocating blades. Durable, ergonomic grip for comfort, control and confidence when cutting.

Item No.	Length	TPI	Quantity
T0820	150mm	6, 18, 24 TPI	8

Plasterboard Saws



Sabretooth 2-Sided Plasterboard Saw

For fast, clean cutting of plasterboard, wood and plastic. Double-sided 1.5mm SK5 Premium Steel Blade for greater versatility. Fast cut 7TPI blade with triple ground teeth for effortless performance. Fine cut 12TPI blade for cleaner, intricate cuts on finished walls or surfaces. Cushion grip handle with anti-slip horns for increased comfort, control & safety. Rigid scabbard with belt mount for convenient, safe storage that prolongs blade life.

Item No.	Length	TPI	Quantity
T0838	120mm	7 / 12 TPI	5



Sabretooth Plasterboard Saw

For fast cutting of plasterboard, wood and plastic. Triple ground 'turbo cut' teeth for improved cutting performance. Rigid 1.5mm premium grade SK5 steel blade. Cushion grip handle with anti-slip horns for increased comfort, control & safety. Supplied with a protective tooth guard for safe storage.

Item No.	Length	Quantity
T0832	150mm	6



Plasterboard Saw

Induction hardened coarse ground cutting teeth & pointed blade for fast cutting of holes in plasterboard for sockets & conduits. (Also known as a dry wall saw).

Item No.		
T0831	150mm (6")	6

Trimming Knives



Multifunction Knife

Easy fit blade holder mechanism enables blade changes in under 3 seconds. Ergonomic, anodised aluminium handle, strong, lightweight & comfortable in use. Quick release, push button locking mechanism for single handed operation. Thumb ledge for greater control and firmer cutting action.

Item No.	
T0955	6



Folding Utility Knife

Ergonomic, anodised aluminium handle, strong, lightweight & comfortable in use. Precision engineered, stainless steel blade holder reduces blade wobble during straight line cuts. Quick release, push button locking mechanism for single handed operation. Easy fit blade holder mechanism enables blade changes in less than 3 seconds. Thumb ledge for greater control and firmer cutting action.

Item No.	
T0954	6
T0954CBOX10	1



Soft Grip Trimming Knives

Robust, die cast aluminium housing - strong and lightweight. Safety interlocking design to prevent the blade slipping through the body joint. Ergonomically designed, soft grip handle for increased comfort and control. Magnetic blade retainer and captive body screw for quick and easy blade changes. Retractable blade for safe storage. String/wire cutting notch for convenience. Internal 5 blade storage compartment.

Item No.	
T0957-1	6
T0957-2	6



Trimming Knives

Robust, die cast aluminium housing - both strong and lightweight. Safety interlocking joint to prevent the blade slipping through the body joint. Magnetic blade retainer & captive body screw for quick & easy blade changes. Retractable blade for safe storage. String/wire cutting notch for convenience. Internal 5 blade storage compartment.

Item No.	
T0956-1	6
T0956-2	6



Safety Trimming Knife

Auto retracting blade for safety in use & storage. Robust, die cast aluminium housing both strong and lightweight. Safety interlocking joint to prevent the blade slipping through the body joint.

Item No.	
T0969	6



Spare Trimming Knife Blades

Heavy duty blades supplied in a spring loaded blade dispenser for safety & convenient storage.

Item No.	i	📦
T0959-10	x 10	12
T0959-50	x 50	12
T0959-100	x 100	12



Snap Off Trimming Knife - 9mm

Lightweight and tough ABS handle grips. Stainless steel body with internal storage for up to two spare blades. Integrated blade snapper and pocket-clip. Retractable blade with push-button positioning for control and safety.

Item No.	i	📦
T0951	Supplied with one blade. Spare blades available: Item No. T0953	12



Snap Off Trimming Knife

Heavy duty plastic body with soft grip handle for comfort & control. Push button blade positioning with locking system for control & safety. Integrated blade snapper for safe blade segment removal. Supplied with 4 blades stored in the handle for convenience.

Item No.	📦
T0958	12



Spare 9mm Trimming Knife Blades

Pack CONTENTS: 10 x 9mm blades. 12 segments per blade. Razor sharp blades - handle with care.

Item No.	i	📦
T0953-10	Compatible with T0951	25

Files & Rasps



Flat Bastard Engineers File

One safe edge.

Item No.	↔	i	📦
T0080B 10	250mm (10")	Flat	3



Engineers Files

One safe edge.

Item No.	↔	i	📦
T0080 6	150mm (6")	Flat 2nd Cut	3
T0080 8	200mm (8")	Flat 2nd Cut	3
T0080 10	250mm (10")	Flat 2nd Cut	3



Spare Snap Off Blades

Heavy duty segmented blades (8 segments) supplied in a spring loaded blade dispenser for safety & convenient storage.

Item No.	📦
T0971-10	12



Flat Smooth Engineers Files

One safe edge.

Item No.			
T0080S 6	150mm (6")	Flat Smooth Cut	3
T0080S 8	200mm (8")	Flat Smooth Cut	3



File/Rasp

1 side bastard rasp. 1 side bastard cut.

Item No.			
T0106 06	150mm (6")	Flat Rasp	3
T0106 08	200mm (8")	Flat Rasp	3



Half Round Engineers Files

Tapered towards the point.

Item No.			
T0082 6	150mm (6")	Half Round 2nd Cut	3
T0082 8	200mm (8")	Half Round 2nd Cut	3
T0082 10	250mm (10")	Half Round 2nd Cut	3



Wood Rasps

Tapered towards the point.

Item No.			
T0107 06	150mm (6")	Half Round Rasp	3
T0107 08	200mm (8")	Half Round Rasp	3



Saw File

Tapered towards the point.

Item No.			
T0074 6	150mm (6")	Triangular	3



Mills Saw File

Flat profile. Single cut.

Item No.			
T0075 10	250mm (10")	Flat	3



Round Engineers Files

Tapered towards the point.

Item No.			
T0083 6	150mm (6")	Round 2nd Cut	3
T0083 8	200mm (8")	Round 2nd Cut	3
T0083 10	250mm (10")	Round 2nd Cut	3



Chainsaw Files

Second cut.

Item No.			
T0079 1	175mm (7")	4mm (5/32")	6
T0079 2	175mm (7")	5mm (3/16")	6
T0079 3	175mm (7")	5.5mm (7/32")	6



Slim Saw File

Tapered towards the point.

Item No.			
T0073 6	150mm (6")	Triangular	3



Extra Slim Saw File

Tapered towards the point.

Item No.			
T0072 5	125mm (5")	Triangular	6



Warding Files

Manufactured from special file steel. Precise cut. Second cut. Wooden handle.

Item No.			
T0120 1	100mm (4")	Flat 2nd Cut, Square	6
T0120 2	100mm (4")	Flat 2nd Cut, Tapered	6
T0120 3	100mm (4")	Half Round 2nd Cut, Rasp	6
T0120 4	100mm (4")	Round 2nd Cut	6
T0120 5	100mm (4")	Square 2nd Cut	6
T0120 6	100mm (4")	Triangular 2nd Cut	6
T0120P	100mm (4")	Set of 6 - Flat, Flat Tapered, Half Round, Round, Square & Triangular.	3



Warding File Set



4 piece set with wooden handles. Manufactured from special file steel. Second cut. CONTENTS: triangular, flat, round and flat tapered.

Item No.			
T0119	100mm (4")	Set of 4 - Triangular, Flat, Round & Flat Tapered.	3



Needle File Set

Manufactured from special file steel. CONTENTS: triangular, square, flat, tapered flat, half round & round.

Item No.			
T0124P	100mm (4")	Set of 6 - Triangular, Square, Flat, Tapered Flat, Half Round & Round	3



Wood Chisel Set

Supplied with silicone carbide sharpening stone & protective storage case. CONTENTS: 1 x wood chisel, sizes: 6, 13, 19, & 25mm. Sharpening stone.

Item No.		
T1180	Set of 5	3



Sharpening Stone

Double sided medium/fine silicon carbide sharpening stone, ideal for sharpening chisels, scissors, shears, etc.

Item No.		
T1126	200 x 50mm	1

Wood Chisels



Wood Chisels

Finest chrome vanadium steel, full length hardened & tempered for long life performance. Shatterproof acetate handle for safety. Replaceable blade cover for protection & safety.

Item No.		
T1178 025	6mm (1/4")	3
T1178 037	10mm (3/8")	3
T1178 050	13mm (1/2")	3
T1178 062	16mm (5/8")	3
T1178 075	19mm (3/4")	3
T1178 087	22mm (7/8")	3
T1178 100	25mm (1")	3
T1178 125	32mm (1 1/4")	3
T1178 150	38mm (1 1/2")	3



Wood Chisel Stand

CONTENTS: 3 x wood chisels, sizes: 6, 10, 13, 16, 19., 22, 25, 32 & 38mm. Sharpening stone.

Item No.		
T1179LS	Stock & stand	1



Automotive & Engineering

Sure-Drive	159
Spanners	162
Rescue Sets	164
Wrenches	164
Hexagon Keys	165
Tap & Die	167
Inspection Mirrors	167
Wire Brushes	167
Grease Guns	167
Funnels	167



Sockets, spanners & wrenches

1. Heavy duty chrome vanadium construction for superior strength and durability.
2. Reversible, 45 tooth ratchet mechanism for a finer working arc (8° arc).
3. Ball bearing locking system with push button release mechanism for quick inter-change of sockets.
4. Dual component, non slip grip for added comfort & control.
5. Forged chrome vanadium steel for superior strength and durability.
6. Non slip, satin chrome plated for resistance to rust and peeling.
7. C.K 'Sure-Drive' system applies torque to the flat of the nut rather than the corners to avoid rounding off.



Sure-Drive



Bi-Hex Sockets - 1/2" Drive

Item No.	↔	📦
T4690M 10	10mm	5
T4690M 11	11mm	5
T4690M 12	12mm	5
T4690M 13	13mm	5
T4690M 14	14mm	5
T4690M 15	15mm	5
T4690M 16	16mm	5
T4690M 17	17mm	5
T4690M 18	18mm	5
T4690M 19	19mm	5
T4690M 20	20mm	5
T4690M 21	21mm	5
T4690M 22	22mm	5
T4690M 23	23mm	5
T4690M 24	24mm	5
T4690M 27	27mm	5
T4690M 30	30mm	5
T4690M 32	32mm	5



Torque Wrench - 1/2" Drive

Micrometer sleeve for accurate torque setting. 1/2" ratchet, reversible, in Nm and Mkg calibrated with their corresponding markings. Individually calibrated and supplied with a certificate of calibration. Supplied in a protective storage case complete with 120mm extension drive & 3/8" square drive adaptor.

DIN 3122, ISO 6789

Item No.	↔	i	📦
T4463	490mm (18")	42 - 210Nm / 30 - 154lb/ft	12



45 Tooth Ratchet Handle - 1/2" Drive

Reversible, 45 tooth ratchet mechanism for a finer working arc (8° arc). Ball bearing locking system with push button release mechanism for quick inter-change of sockets.

Item No.	↔	📦
T4691	260mm (10")	5



Flexible Handle - 1/2" Drive

Pivoted drive for angled access in tight spaces.

Item No.	↔	📦
T4692	430mm (17")	5



24 Tooth Ratchet Handle - 1/2" Drive

Reversible, 24 tooth ratchet mechanism for high torque applications. Heavy duty chrome vanadium construction for superior strength & durability. Ball bearing locking system with push button release mechanism for quick inter-change of sockets. Drive: 1/2".

Item No.	↔	📦
T4603	270mm	3
T4603 1		1



Sliding T-Handle - 1/2" Drive

Forged chrome vanadium steel. Drive: 1/2".

Item No.	↔	📦
T4695	250mm (10")	5



Long Extension - 1/2" Drive

Forged chrome vanadium steel. Drive: 1/2".

Item No.		
T4693	250mm (10")	5



Short Extension - 1/2" Drive

Forged chrome vanadium steel. Drive: 1/2".

Item No.		
T4694	125mm (5")	5



Universal Joint - 1/2" Drive

Forged chrome vanadium steel. Drive: 1/2".

Item No.	
T4696	5



Socket Accessory Stand

CONTENTS: 3 x ratchet handle, 3 x sliding t-handle, 3 x flexible handle, 3 x long extension, 3 x short extension and 3 x universal joint.

Item No.	
T4645S	1



Pocket Socket Set - 1/4" Drive

Forged Chrome Vanadium steel for superior strength & durability. 'Sure drive' system applies torque to the flat of the nut rather than the corners to avoid rounding off. Contents: 1/4" sockets (4, 4.5, 5, 5.5, 6, 7, 8, 9, 10, 11, 12, 13, 14mm), 1/4" x 25mm bit adaptor, 1/4" x 50mm extension bar, 1/4" x 72 teeth ratchet handle, 1/4" x 25mm bits (PH 1, 2, 3; PZ 1, 2, 3; TX 15, 20, 25; HEX 4, 5, 6mm)

Item No.	
T4654	3



Coloured 1/4" Socket Set/17

17 piece professional colour coded socket set - 72 tooth ratchet wrench. High torque 12 point sure drive sockets. Apply torque to the flat of the nut rather than the corners to avoid rounding off. Forged Chrome Vanadium steel for superior strength & durability. Contents - Sockets - 4, 4.5, 5, 5.5, 6, 7, 8, 9, 10, 11, 12, 13, 14mm. Accessories - Short extension, 1/4" drive handle, Universal joint.

Item No.	
T4658	20



Socket Set/36 - 1/4" Drive

Heavy duty chrome vanadium construction for superior strength and durability. Reversible, 72-teeth ratchet mechanism for fine adjustment in confined spaces. Ball bearing locking system with push-button release mechanism for quick interchange of sockets. Dual component, non-slip grip for added comfort and control. Hex and Bi-Hex design to accommodate a range of fasteners and bolts. Rust-resistant satin chrome finish. C.K Sure-Drive system applies torque to the flat of the nut rather than the corners to avoid rounding-off. Contents: Sockets (hexagonal) sizes: 4 / 4.5 / 5 / 5.5 / 6 / 7 / 8 / 9 / 10 / 11 / 12 / 13 and 14mm, 72 teeth reversible 1/4", 75mm extension, 1/4" universal gimbal, 1/4 "x1/4" bit adapter, 1/4 "x1/4" hex adapter, screwdriver bits: slotted: 4 / 4.5 / 7mm, TX15, 20, 25,30, hexagonal 3, 4, 5, 6mm, PH1, 2, 3, PZ1, 2, 3.

Item No.	
T4660	10



Socket Set/39 - 1/4" Drive

Metric socket set, forged from Chrome Vanadium steel. All contents have a non-slip satin chrome finish giving maximum resistance to rust and peeling. Sure Drive system exerts torque through the flats of the socket rather than the corners, thus eliminating "rounding off" at high torque. Ratchet with comfortable two compound handle. Contents of set: 1/4" ratchet, 45 tooth. Sockets: 4 / 4.5 / 5 / 5.5 / 6 / 7 / 8 / 9 / 10 / 11 / 12 / 13 and 14 mm. Bits for use with ratchet: Hexagon: 3, 4, 5 and 6 mm. Tamperproof-TX: T8, 10, 15, 20, 25, 27, 30 and 40. Pozidriv: 1, 2, 3. Phillips: 1, 2, 3. Slotted: 4 / 5.5 and 7 mm. Extension 50 mm. 1/4" drive handle. Universal joint. Hex to 1/4" drive adaptor.

Item No.

T4655



3



Socket Set/23 - 3/8" Drive

Heavy duty chrome vanadium construction for superior strength and durability. Reversible, 72-teeth ratchet mechanism for fine adjustment in confined spaces. Ball bearing locking system with push-button release mechanism for quick interchange of sockets. Dual component, non-slip grip for added comfort and control. Hex and Bi-Hex design to accommodate a range of fasteners and bolts. Rust-resistant satin chrome finish. C.K Sure-Drive system applies torque to the flat of the nut rather than the corners to avoid rounding-off. Contents: Sockets (12 tips) sizes: 6, 7, 8, 9, 10, 11, 12, 13, 14, 15, 16, 17, 18, 19, 21, 22 and 24mm, 72 reversible teeth 3/8", 75mm and 150mm extensions, 3/8" universal toggle, 3/8 "Mx1/2 "F T-handle adapter.

Item No.

T4661



10



Coloured 3/8" Socket & Spanner Set

12 piece professional colour coded socket and spanner set - 72 tooth ratchet wrench. High torque 12 point sure drive sockets. Apply torque to the flat of the nut rather than the corners to avoid rounding off. Forged Chrome Vanadium steel for superior strength & durability. Contents - Sockets - 8, 10, 13, 15, 17mm. Combination spanners - 8, 10, 13, 15, 17mm. Short extension.

Item No.

T4659



10



Socket Set/22 - 1/2" Drive

Heavy duty chrome vanadium construction for superior strength and durability. Reversible, 72-teeth ratchet mechanism for fine adjustment in confined spaces. Ball bearing locking system with push-button release mechanism for quick interchange of sockets. Dual component, non-slip grip for added comfort and control. Hex and Bi-Hex design to accommodate a range of fasteners and bolts. Rust-resistant satin chrome finish. C.K Sure-Drive system applies torque to the flat of the nut rather than the corners to avoid rounding-off. Contents: Sockets (12 point Bi-Hex) sizes: 10, 11, 12, 13, 14, 15, 16, 17, 18, 19, 20, 21, 22, 24, 27, 30 and 32mm, Long reach sockets 16 and 21mm, 72 1/2" reversible teeth, 125mm and 250mm extensions, 1/2" universal toggle, Adapter for 1/2 "Mx3/8 "F T-handle.

Item No.

T4662



5



Combination Spanners

1. Drop forged chrome vanadium steel, hardened & tempered for strength & durability.
2. Heavy duty chrome plated for corrosion resistance.
3. 12° offset bi-hex ring.



Spanners



Combination Spanners

Item No.	↔	↷	i	📦
T4343M 06	100mm	6mm	Loose	10
T4343M 06H	100mm	6mm	On hanger	6
T4343M 07	110mm	7mm	Loose	10
T4343M 07H	110mm	7mm	On hanger	6
T4343M 08	120mm	8mm	Loose	10
T4343M 08H	120mm	8mm	On hanger	6
T4343M 09	130mm	9mm	Loose	10
T4343M 09H	130mm	9mm	On hanger	6
T4343M 10	140mm	10mm	Loose	10
T4343M 10H	140mm	10mm	On hanger	3
T4343M 11	150mm	11mm	Loose	10
T4343M 11H	150mm	11mm	On hanger	3
T4343M 12	160mm	12mm	Loose	10
T4343M 12H	160mm	12mm	On hanger	3
T4343M 13	170mm	13mm	Loose	10
T4343M 13H	170mm	13mm	On hanger	3
T4343M 14	180mm	14mm	Loose	10
T4343M 14H	180mm	14mm	On hanger	6
T4343M 15	190mm	15mm	Loose	10
T4343M 15H	190mm	15mm	On hanger	6
T4343M 16	200mm	16mm	Loose	10
T4343M 16H	200mm	16mm	On hanger	6
T4343M 17	210mm	17mm	Loose	10
T4343M 17H	210mm	17mm	On hanger	3
T4343M 18	220mm	18mm	Loose	10
T4343M 18H	220mm	18mm	On hanger	1
T4343M 19	230mm	19mm	Loose	10
T4343M 19H	230mm	19mm	On hanger	1
T4343M 20	240mm	20mm	Loose	5
T4343M 20H	240mm	20mm	On hanger	1
T4343M 21	250mm	21mm	Loose	5
T4343M 21H	250mm	21mm	On hanger	1
T4343M 22	260mm	22mm	Loose	5
T4343M 22H	260mm	22mm	On hanger	1
T4343M 24	280mm	24mm	Loose	5
T4343M 24H	280mm	24mm	On hanger	1
T4343M 27	310mm	27mm	Loose	5
T4343M 27H	310mm	27mm	On hanger	1
T4343M 30	340mm	30mm	Loose	5
T4343M 30H	340mm	30mm	On hanger	1
T4343M 32	360mm	32mm	Loose	5
T4343M 32H	360mm	32mm	On hanger	1





Combination Spanner Set/10

10 piece set supplied in a wall mounting rack for convenient storage. Drop forged chrome vanadium steel, hardened & tempered for strength & durability. Heavy duty chrome plated for corrosion resistance. 12° offset bi-hex ring. CONTENTS: 8, 9, 10, 11, 12, 13, 14, 15, 17, & 19mm.

DIN 3113

Item No.	
T4343M/10ST	3



Combination Spanner Set/12

12 piece set supplied in a wall mounting rack for convenient storage. Drop forged chrome vanadium steel, hardened & tempered for strength & durability. Heavy duty chrome plated for corrosion resistance. 12° offset bi-hex ring. CONTENTS: 8, 9, 10, 11, 12, 13, 14, 15, 17, 19, 21 & 22mm.

DIN 3113

Item No.	
T4343M/12ST	1



Speed Spanners Set/6

Drop forged chrome vanadium steel, hardened & tempered for strength & durability. Colour coded for quick selection of the correct size. Innovative ratchet action style jaw for use in tight places. 12° offset bi-hex ring for access. Supplied in a wall mounting rack for convenient storage. CONTENTS: 10, 12, 13, 14, 15 & 17mm.

Item No.	
T4345/6ST	5



Metric Ratchet Spanner Set/7

7 piece set supplied in a wall mounting rack for convenient storage. Drop forged chrome vanadium steel, hardened & tempered for strength & durability. Heavy duty chrome plated for corrosion resistance. CONTENTS: 8, 10, 12, 13, 15, 17 & 19mm.

DIN 3113

Item No.	
T4344M7ST	5



Colour Coded Spanner Set/12

Drop forged chrome vanadium steel, hardened & tempered for strength & durability. Colour coded for quick selection of the correct size. CONTENTS: 6, 7, 8, 9, 10, 11, 12, 13, 14, 15, 17 & 19mm.

Item No.	i	
T4346M12ST	Set of 12	10



Rescue sets

Patented extractor inserts for ring spanners and sockets. Securely grips rounded edges and works on fasteners with up to 85% damaged or worn corners.



Patented extractor hex key set removes damaged hex fasteners with up to 100% rounded heads. Multi-purpose design for installing new fasteners.



Rescue Sets



Damaged Nut Extractor Set

Adaptors for fixings sized 8, 9, 10, 11, 12, 13, 14, 15, 16 and 17mm. Works on a range of fasteners: 6 point, 12 point, Hex and Spline. Adapts just two socket/ring spanner sizes to fit 10 different fasteners (sizes 8-17mm). 8-12mm Inserts suit 14mm wrench / 12-17mm Inserts suit 19mm wrench. Unique Flange design to prevent fall through.

Item No.

T4360



30



Damaged Hex Bolt Rescue Set

Ball-ended for use at an angle of up to 25 degrees where access is restricted. Sizes: 1.5, 2, 2.5, 3, 4, 5, 6, 8 and 10mm. Folding carry clip for convenience.

Item No.

T4440M



6

Wrenches



Adjustable Wrenches - Sure-Drive

C.K Sure-Drive jaws which apply torque to the flat of the nut rather than the corners to avoid rounding off. Forged chrome vanadium for strength & durability. Matt chrome plated for corrosion protection. Extra capacity jaws - up to 18% wider than standard patterns. Metric & imperial graduations for accurate jaw pre-setting. Soft grip handle for comfort & control.

Item No.

T4365 150



150mm (6")



24mm



3

T4365 200

200mm (8")

29mm

3

T4365 250

250mm (10")

33mm

3

T4365 300

300mm (12")

38mm

3



Adjustable Wrenches - Wide Jaw

Forged chrome vanadium for strength & durability. Extra capacity jaws - up to 26% wider than standard patterns. Precision ground, fully polished jaws for secure nut engagement. Metric graduations for accurate jaw pre-setting.

Item No.			
T4366 150	150mm (6")	24mm	6
T4366 200	200mm (8")	29mm	6
T4366 250	250mm (10")	33mm	6
T4366 300	300mm (12")	38mm	6
T4366 375	375mm (15")	51mm	5
T4366 450	450mm (18")	60mm	5



Self Grip Wrench - Concave Jaws

Forged chrome vanadium jaws for strength & durability. Concave jaws ideal for gripping round profile. Integral wire cutting blades. Epoxy coated for corrosion protection. Quick release lever.

Item No.			
T3630 10	250mm (10")	50mm	5



Self Grip Wrench - V-Jaws

Forged chrome vanadium jaws for strength & durability. Combination straight & curved jaws ideal for gripping round, flat & square profile. Epoxy coated for corrosion protection. Quick release lever.

Item No.			
T3638 07	180mm (7")	25mm	6
T3638 10	250mm (10")	35mm	6



Self Grip Wrench - Straight Jaws

Forged chrome vanadium jaws for strength & durability. Flat jaws ideal for gripping flat profile. Epoxy coated for corrosion protection. Quick release lever.

Item No.			
T3641	250mm (10")	40mm	5

Hexagon Keys



Hexagon Keys - Metric

Chrome vanadium steel. Hardened and tempered for strength and durability. ISO 2936

Item No.				
T4411 007	0.7mm	32mm	6mm	12
T4411 009	0.9mm	32mm	10mm	12
T4411 01	1.0mm	32mm	10mm	12
T4411 012	1.2mm	38mm	10mm	12
T4411 0127	1.27mm	40mm	12mm	12
T4411 015	1.5mm	45mm	14mm	12
T4411 02	2.0mm	50mm	16mm	12
T4411 025	2.5mm	56mm	18mm	12
T4411 03	3.0mm	63mm	20mm	12
T4411 035	3.5mm	67mm	23mm	12
T4411 04	4.0mm	71mm	25mm	12
T4411 045	4.5mm	75mm	26mm	12
T4411 05	5.0mm	80mm	28mm	12
T4411 055	5.5mm	85mm	30mm	12
T4411 06	6.0mm	90mm	32mm	12
T4411 07	7.00mm	95mm	34mm	12
T4411 08	8.0mm	100mm	36mm	12
T4411 09	9.0mm	105mm	38mm	12
T4411 10	10.0mm	112mm	40mm	12
T4411 11	11.0mm	118mm	43mm	12
T4411 12	12.0mm	125mm	45mm	6
T4411 13	13.0mm	133mm	50mm	6
T4411 14	14.0mm	140mm	56mm	3
T4411 15	15.0mm	147mm	58mm	3
T4411 16	16.0mm	154mm	60mm	3
T4411 17	17.0mm	160mm	63mm	3
T4411 18	18.0mm	170mm	65mm	3
T4411 19	19.0mm	180mm	70mm	3
T4411 20	20.0mm	187mm	73mm	3
T4411 22	22.0mm	200mm	80mm	3



Hexagon Key Folding Set/8

Professional quality fully hardened chrome vanadium steel blades. Dual component holder for convenient storage.

Item No.	
T4406	6



Coloured Hex Key Set/9

Premium quality S2 steel blades, tempered and hardened for exceptional strength & durability. Screws can be tightened or loosened at angles up to 25°. CONTENTS: 1.5, 2, 2.5, 3, 4, 5, 6, 8, 10mm.

Item No.	
T4449	3



Hexagon Key Clip Set/9

Chrome vanadium steel, hardened & tempered for strength & durability. Ball ended for use at an angle of up to 25° where access is restricted. Supplied in a storage holder.

Item No.		
T4444I	Imperial AF $\frac{5}{64}$, $\frac{3}{32}$, $\frac{1}{8}$, $\frac{5}{32}$, $\frac{3}{16}$, $\frac{7}{32}$, $\frac{1}{4}$, $\frac{5}{16}$, $\frac{3}{8}$ "	6



Hexagon Key TX Tamperproof Set

Professional quality fully hardened chrome vanadium steel blades. Dual component holder for convenient storage. CONTENTS: T8, T9, T10, T15, T20, T25, T27, T30, T40.

Item No.	
T4409	3



Hexagon Key Clip Set/10

Chrome vanadium steel, hardened & tempered for strength & durability. Ball ended for use at an angle of up to 25° where access is restricted. Supplied in a storage holder.

Item No.		
T4443M	Metric 1.5, 2, 2.5, 3, 4, 5, 6, 7, 8, 10mm	6

Tap & Die



Tap & Die Set/21 - Metric

High carbon steel, hardened & tempered for strength and durability. Precision machined to produce accurate thread forms. CONTENTS: Tap & dies, sizes: 3 x 0.5, 4 x 0.7, 5 x 0.8, 6 x 1.0, 7 x 1.0, 8 x 1.25, 10 x 1.5, 12 x 1.75mm & 1/8" NPT. Tap wrench. Die stock. Screwdriver.

Item No.		
T4032		10

Inspection Mirrors



Inspection Mirrors - Telescopic

Telescopic shaft. Stainless steel. Swivel head. Pocket clip.

Item No.			
T5913 32	180 - 520mm	32mm	6
T5912 38	125 - 685mm	38mm	6
T5912 55	125 - 560mm	55mm	6



Inspection Mirror - Extra Long

Telescopic shaft. Stainless steel. Swivel head. Comfort handle.

Item No.			
T5914 55	250 - 780mm	55mm	6

Wire Brushes



Wire Brush

Hardened & tempered steel wire bristles, set in 4 rows for professional results.

Item No.		
T6238 4	4 Rows	12

Grease Guns



Grease Gun and Accessories

Heavy duty construction grease gun with pressure head. Multiple loading: cartridge, grease gun filler or bulk. Precision machined piston and pump cylinder. Air release valve. Wide safety knurls for a sure grip. Supplied complete with angled delivery tube and 4 jaw hydraulic coupler. Delivery pressure 400/5800 psi.

Item No.				
T6270	500cm ³	66g		10
T6270 2	300mm	32g	Flexible Hose	10
T6270 3	450mm	84g	Flexible Hose	6
T6270 4			Coupler	6
T6270 5			Grease Cartridge	36

Funnels



Metal Funnel

Bright tin plated funnel. Flexible detachable metal hose. With plastic spout and brass filter.

Item No.		
T6274 2	3.2ltr / 300mmØ	6



Plastic Funnel

Polythene funnel with flexible, detachable metal hose, plastic spout and brass filter.

Item No.		
T6275 1	3.2ltr / 160mmØ	10



Marking & Measuring

Tape Measures	170
Spirit Levels	171
Rules	172
Chalk Lines & Accessories	172
Joiners Bevels & Squares	173
Combination Squares	174
Vernier Calipers	175
Feeler Gauges	175
Pens & Pencils	175
Pocket Balances	175



XT & AT tapes

Professional quality tape measures featuring advanced tape technology to cater for the most demanding requirements.

1. Nylon coated blade for superior wear resistance.
2. Rubber casing for a strong grip and impact protection.
3. Double sided blade markings for regular, overhead and vertical measuring.

XT tape - Manual blade lock, powerful, non-slip.
AT tape - Automatic blade locking mechanism.



Tape Measures



XT Tape Measures

Express blade brake - instant locking. Dual function end hook - top and bottom hooks for convenience. Shock absorbing device at the blade retraction hole. Metal belt clip.

2014/22/EC Class 2

Item No.						
T3448 16	5m / 16ft	Metric / Imperial	2.3m Stand Out	25mm	305g	6
T3448 25	7.5m / 25ft	Metric / Imperial	2.8m Stand Out	27mm	470g	6
T3448M 5	5m	Metric	2.3m Stand Out	25mm	305g	6



AT Auto Lock Tape Measure

Automatic blade locking mechanism. Shock absorbing device at the blade retraction hole. Metal belt clip.

2014/22/EC Class 2

Item No.						
T3447 16	5m / 16ft	Metric / Imperial	2.3m Stand Out	25mm	285g	6



Softech Tape Measures

Tough ABS plastic body for damage protection. Full lock & pause buttons for control. Belt clip for convenience. Nylon coated blade - superior abrasion resistance & durability. 400mm joist centre markings for fast marking out. True zero hook for accurate external & internal measurements. Integral recoil damper for hook damage protection.

2014/22/EC Class 2

Item No.			
T3442 10	3m / 10ft	Metric / Imperial	6
T3442 16	5m / 16ft	Metric / Imperial	6
T3442 25	7.5m / 25ft	Metric / Imperial	6
T3442M 3	3m	Metric	6
T3442M 5	5m	Metric	6
T3442M 8	8m	Metric	6



Fibreglass Measuring Tape

Tough ABS plastic body for damage protection. Fold out blade hook for secure anchoring. Hand strap for convenient carrying, Fold out winding handle for rapid rewind & safe storage. Glassfibre reinforced tape - strong & stretch resistant. Double sided metric/imperial graduations.

20144/22/EC Class 3

Item No.			
T3561 100	30m (100ft)	13mm (1/2")	3



Steel Measuring Tape

Tough steel case for damage protection. Fold out blade hook for secure anchoring. Hand strap for convenient carrying, Fold out winding handle for rapid rewind & safe storage. Glassfibre reinforced tape - strong & stretch resistant. Nylon coated steel tape - extremely strong & stretch resistant. Double sided metric/imperial graduations.

20144/22/EC Class 3

Item No.			
T3563 100	30m (100ft)	13mm (1/2")	3



Surveyors Tapes

Tough ABS plastic body for damage protection. Integral ground spike & fold out blade hook for secure anchoring. Soft grip handle for comfortable carrying. Fold out winding handle for rapid rewind & safe storage. Glassfibre reinforced tape - strong & stretch resistant. Double sided metric/imperial graduations.

20144/22/EC Class 3

Item No.			
T3565 100	30m (100ft)	13mm (1/2")	3
T3565 165	50m (165ft)	13mm (1/2")	3
T3565 330	100m (330ft)	13mm (1/2")	3

Spirit Levels



Box Section Spirit Levels

Powder coated, box section aluminium - strong, light & durable. Shockproof, unbreakable vials, guaranteed leakproof for three years. Luminous horizontal vial for low light conditions. Precision manufactured, accurate to +/- 0.5mm per metre. Metric measurement graduations for convenience.

Item No.			
T3494 16	400mm (16")	2 vial with rule	30
T3494 24	600mm (24")	2 vial with rule	30
T3494 32	800mm (32")	3 vial with rule	30
T3494 40	1000mm (40")	3 vial with rule	30
T3494 48	1200mm (48")	3 vial	10
T3494 70	1800mm (70")	3 vial	10



Pocket Level

Tough ABS plastic body for damage protection. V-groove base for pipework. Magnetic base for steelwork. Patented detachable mini level with magnetic base, ideal for setting pattress boxes. Also features string slots for use as line level. 1 vertical & 1 horizontal vial.

Item No.		
T3482	210mm (8 1/4")	5

Rules



Straight Edge Rule

Anodised aluminium construction with a strong plastic handle - lightweight, easy clean. Metric graduations. Ideal for cutting, measuring and marking out.

Item No.		
T3531 100	100mm (4")	1



Folding Rule

Made of high-quality beech wood. Joints riveted, brass coated springs. High accuracy. Section Thickness: 3mm. Section Height: 16mm.

20144/22/EC Class 3

Item No.		
T3514	2000mm (6ft)	1



Steel Rules

Stainless steel for corrosion protection. Permanent indented markings for wear resistance. Fine graduations for accurate measurements.

Item No.			
T3530 06	150mm (6")	18mm	6
T3530 12	300mm (12")	25mm	6

Chalk Lines & Accessories



Heavy Duty Chalk Line Reel Set

Die cast aluminium construction. Strong & lightweight. Fold away winding handle for convenient storage. Self chalking line with end attachment hook. Supplied with 60g of blue chalk.

Item No.		
T3520B	30m (100ft)	6



Chalk Line Reel and Chalk

Tough plastic construction - strong & lightweight. Fold away winding handle for convenient storage. Self chalking line with end attachment hook for ease of use. Supplied with 60g of blue chalk.

Item No.		
T3522	30m (100ft)	6



Plumb Bob

Conical, fully polished bob complete with screwed brass cord fitting.

Item No.	
T3492 11	3



Chalk Line - Braided Nylon

Braided nylon construction - extra strong & durable.

Item No.		
T3519	18m (60ft)	12



Chalk Line - Cotton

Strong & absorbent cotton for effective retention of marking chalk.

Item No.		
T3517	18m (60ft)	12



Chalk Powder

High density chalk for clear marking results. Plastic refill container with re-sealable dispenser cap.

Item No.			
T3521B 100	Blue	100g (4oz)	6
T3521R 100	Red	100g (4oz)	6

Joiners Bevels & Squares



Joiners Square - Rosewood

Hardened & tempered blued steel blade for corrosion resistance. Blade secured with three brass rivets & brass inside face for long term accuracy. Hard rosewood stock.

Item No.		
T3540 09	225mm (9")	3
T3540 12	300mm (12")	3



Sliding Bevel - Rosewood

Hardened & tempered blued steel blade for corrosion resistance. Quick lock lever for convenient adjustment. Hard rosewood stock.

Item No.		
T3541 9	225mm (9")	4



Marking Gauge - Rosewood

Screw pin adjustment for accurate & consistent setting of mortice & tenon joints. Heavy brass inlays on marking faces for protection. Hard rosewood body.

Item No.		
T3543	190mm (7 1/2")	1



Joiners Square - Beech

Hardened & tempered blued steel blade for corrosion resistance. Blade secured with three brass rivets & brass inside face for long term accuracy. Beech stock.

Item No.		
T3533 09	225mm (9")	3



Sliding Bevel - Beech

Hardened & tempered blued steel blade for corrosion resistance. Beechwood stock.

Item No.		
T3537 09	230mm (9")	3



Marking Gauge - Beech

Thumbscrew adjustment for accurate & consistent marking. Brass inlays on marking faces for protection. Beechwood body.

Item No.		
T3542A	240mm (9 1/2")	3

Combination Squares



Combination Square - 3 in 1

Heavy duty, 3 in 1 construction for a complete marking & measuring solution. Stainless steel rule for corrosion protection. Permanent indented markings for wear resistance.

Item No.		
T3579	300mm (12")	1



Heavy Duty Combination Square

Heavy duty construction for strength & durability. Stainless steel rule for corrosion protection. Permanent indented markings for wear resistance.

Item No.		
T3581	300mm (12")	3



Combination Square

Stainless steel rule for corrosion protection. Permanent indented markings for wear resistance.

Item No.		
T3582	210mm (8 1/4")	3

Vernier Calipers



Vernier Caliper

Roller adjustment along metric & imperial graduated rule for convenience. Nickel plated for corrosion protection.

Item No.		
T3451	125mm (5")	6



Professional Marker Pen

Quick drying ink - dries within 5 seconds on most surfaces, eliminating smudges. Waterproof - for writing in wet, greasy and gritty conditions. 1mm Bullet Nib - fine bullet nib design for access to tight spots, imprinting a 1mm line. Premium quality acrylic nib - non-toxic, low odour, job site ready. Permanent - indelible ink for writing permanently or semi-permanently on a wide variety of surfaces.

Item Number				
T1130	13.5mm	1mm	< 5 seconds	50

Feeler Gauges



Feeler Gauges

Blades permanently etched with its size for long term use. BS EN 957:2008 part 2 and DIN 2275:2014 grade 2

Item No.			
T3527 413	100mm (4")	Imperial	3
T3527M 413	100mm (4")	Metric	3

Pens & Pencils



Carpenters Pencil

Traditional rectangular leaded carpenters pencil. For noting of dimensions etc.

Item No.		
T1125 24	240mm	25

Pocket Balances



Pocket Balances

Brassed scale, black lacquered body, tinned hook & ring for corrosion resistance. Calibrated in 1lb/0.5Kg divisions.

Item No.		
T6202 025	12.5kg (25lb)	12
T6202 032	15kg (32lb)	12
T6202 044	20kg (44lb)	12
T6202 050	23kg (50lb)	6
T6202 066	30kg (66lb)	6
T6202 088	40kg (88lb)	6
T6202 112	50kg (112lb)	6



Water Systems

Hose Connectors

178

Hose Accessories

180

Hose Pipes

181



Water systems

The range of C.K hose connectors is precision engineered to be long lasting and leak free. The fittings are solid brass, so are much more hard wearing than plastic systems and are rust resistant. They are compatible with all popular makes of hoses of both 1/2" and 3/4" bores.

1. Solid brass - tough and corrosion resistant.
2. Ball bearing locking - secure and hard wearing.
3. Threaded clamp for a secure fit to hosepipe.

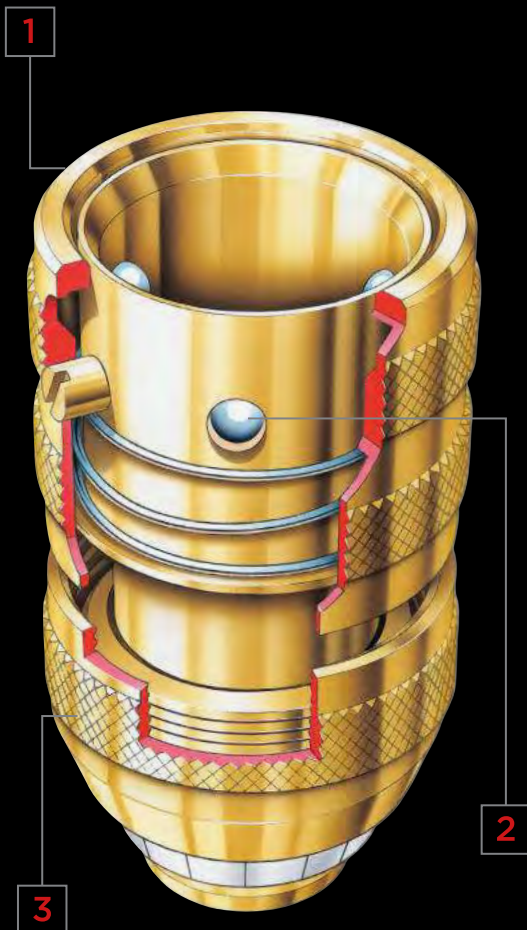

Hose Connectors



Hose Connectors - Male

Simple and user friendly fitting.

Item No.	Ø	
G7904	1/2"	6
G7934	3/4"	6



Hose Repairers

Secure screw down hose connector for permanently joining two hoses or re-joining a hose when a damaged section has been cut out.

Item No.	Ø	
G7924	1/2"	6
G7932	3/4"	6



Hose Connector Display

CONTENTS: 12 x hose connectors: female (1/2"), 6 x hose connectors: male (1/2"), male & female, double male, triple male & water stop (1/2"), 6 x tap connectors: threaded female (1/2"), threaded female (5/8") & threaded female (3/4"), 3 x tap connectors: threaded male (1/2"), threaded male (3/4"), two-way (3/4"), push-on (standard bore) & push-on (large bore), 6 x hose repairers (1/2"), 6 x adjustable spray guns, 6 x adjustable spray nozzles.

Item No.		
G7900ALS	Stock & stand	1



Hose Connectors - Female

Used at both ends of a hose pipe.

Item No.	Ø	
G7903	1/2"	6
G7933	3/4"	6



Hose Connectors

Ideal to extend hose pipes.

Item No.	Ø	
G7907	1/2"	6
G7907Y	1/2"	6



Hose Connector - Male & Female

Suitable for extension / reduction of hose length.

Item No.	Ø	
G7905	1/2"	6



Hose Connector - Water Stop

Automatic water cut off feature allows the interchange of accessories such as sprinklers, nozzles, spray guns, etc.

Item No.	Ø	
G7913	1/2"	6



Tap Connectors - Threaded Female

Tap connector for threaded taps. Screwed onto the tap, the connector provides a quick coupling to the system.

Item No.	Ø	
G7915 50	1/2"	6
G7915 62	5/8"	6
G7915 75	3/4"	6



Tap Connectors - Threaded Male

Ideal for converting a female threaded tap or other equipment such as jet washers to connect to a female hose coupling.

Item No.	Ø	
G7916 50	1/2"	6
G7916 75	3/4"	6



Tap Connector - 2 Way

For 3/4" external-threaded taps. Two outlets each featuring a cut off valve that can be individually closed.

Item No.	Ø	Icon
G7918	3/4"	6



Adjustable Spray Gun

Comfortable ergonomic design with lockable on/off trigger and precise easy to use spray to jet adjustment.

Item No.	Icon
G7943	3



Tap Connectors - Push-On

Tightens to smooth bore taps by screw clip (not suitable for high water pressures).

Item No.	i	Icon
G7919	Standard bore (10 - 20mm)	3
G7928	Large bore (20 - 30mm)	3



Spare O-Rings

Brass Interlock O-Rings.

Item No.	i	Icon
G7980	Packet of 20	6

Hose Accessories



Adjustable Spray Nozzle

Adjustable spray fitting with male end. Simple turn adjustment varies flow from "off" through spray to hard jet.

Item No.	Icon
G7912	6



Rose Spray

Diffuses water through hundreds of holes to provide a gentle spray pattern, suitable for delicate plants. 36" long reach arm, lightweight design and comfort grip ensures ease of use in all watering situations. On/off volume control.

Item No.	Icon
G7945	900mm (36") 1



Lawn Sprinkler - Oscillating

Covers 200m² at a 5 bar pressure. Adjustable to 4 modes of spread: full, right, left or centre. With internal filter.

Item No.	
G7756BI	1



Lawn Sprinklers - Pulse Jet

Covers 450m² at a minimum pressure of 1.2 bar. Adjustable watering arc for full circle or partial segment coverage.

Item No.	
G7752BI	
G7755BI	3



Pro-Flex Hose Pipes - 3/4"

High quality, triple layered, polyester reinforced for extra strength & resistance to twisting and stretching. Abrasion resistant PVC outer layer for long life. UV stable. Burst pressure 35 bar.

Item No.			
G7626 15	15m	19mm (3/4")	10
G7626 30	30m	19mm (3/4")	5
G7626 50	50m	19mm (3/4")	3

Hose Pipes



Pro-Flex Hose Pipes - 1/2"

Highly flexible hose pipe 1/2" / 13mm. Premium quality, triple layered, polyester reinforced for extra strength & resistance to twisting and stretching. Heavy duty, abrasion resistant PVC outer layer for superior elasticity at low temperatures. UV stable. Burst pressure 35 bar.

Item No.			
G7625 15	15m	13mm (1/2")	10
G7625 30	30m	13mm (1/2")	5
G7625 50	50m	13mm (1/2")	3
G7625 75	75m	13mm (1/2")	2



Multi-Flex Hose Pipes - 1/2"

High quality 1/2" hose pipe, triple layered, polyester reinforced for extra strength & resistance to twisting and stretching. Abrasion resistant PVC outer layer for long life. UV stable. Burst pressure 28 bar.

Item No.			
G7621 15	15m	13mm (1/2")	10
G7621 30	30m	13mm (1/2")	5
G7621 50	50m	13mm (1/2")	3



Lighting

Inspection Lights

184

Floodlights

186

Head Torches

187



Inspection Lights

With a host of features and manufactured from impact resistant materials to survive whatever the jobsite throws at you.

1. Easy fixation with integrated magnets.
2. Compact Inspection light with dual function LED.
3. CKlearView LED for accurate colour rendering.



Inspection Lights



C.K. MINI LED Inspection Light

Compact Inspection light with dual function LED. Lightweight pocket friendly design with clip. Tactile on/off mode switch. CKlearView LED for accurate colour rendering. 120lm main light. 80lm torch light. 3.7V 750mAh Li-ion battery for up to 4.5 hours runtime. USB-C rechargeable in 1.5 hours (cable included).

Item No.	i	📦
T9426USB	150lm	5



C.K. MIDI LED Inspection Light

High powered Inspection light with dual function LED. IK07 moulded design for exceptional durability. Tactile on/off mode switch. CKlearView LED for accurate colour rendering. 400lm main light with eco mode (250lm). 100lm torch light. Flexible 180° folding design with magnetic base. Retractable 360° rotating hook. IP54 rated against dust and water ingress. 3.7V 2600mAh Li-ion battery for up to 5.0 hours runtime. Battery level indicator. USB-C rechargeable in 3.5 hours (cable included).

Item No.	i	📦
T9427USB	400lm	8



C.K. MAXI LED Inspection Light

High Powered Inspection light with dual function LED. IK07 moulded design for exceptional durability. Tactile on/off mode switch. CKlearView LED for accurate colour rendering. 700lm dimmable main light with eco mode (175lm). 150lm torch light. Flexible 180° folding design with magnetic base. Retractable 360° rotating hook. IP65 rated against dust and water ingress. 3.7V 2600mAh Li-ion battery for up to 8.0 hours runtime. Battery level indicator. USB-C rechargeable in 3.5 hours (cable included).

Item No.	i	📦
T9428USB	700lm	5





Neck Light - 300lm

Versatile LED neck light with adjustable brightness. Ergonomic design for comfortable all day use. Individual light control via independent on/off switches. CKclearView LED for accurate colour rendering. Max. 300lm with dimmer function. Flexible antenna for optimum light orientation. Magnetised and threaded base gives a choice of mounting options. USB-C rechargeable with battery charge indicator (cable included).

Item No.		
T9429USB	300lm	5

Compact Inspection Light - USB

T4924USB: 240 lumen COB-LED. Battery life: standard/red up to 2.5hrs, torch up to 4hrs, tip up to 14 hrs. Charge time: 4hrs. Supplied with type C USB charger cable (UK mains plug not included).

T9425USB: 400 lumen COB-LED. Battery life: standard/red up to 3hrs, torch up to 5hrs, tip up to 17hrs. Charge time: 4hrs. Supplied with type C USB charger cable (UK mains plug not included).

CE UKCA



Item No.		
T9424USB	130H x 27W x 41D (mm)	12
T9425USB	158H x 31W x 66D (mm)	12

Mini Inspection Light - USB

High performance 240 lumen COB-LED. 2 Lighting modes: high, dimmed. Battery indicator light. Battery life: up to 2.5 hrs. Charge time: 2.5 hrs. Integrated rechargeable 3.7V 600mAh Li-Ion battery. Integrated pocket clip and magnetic base. Supplied with type C USB charger cable (UK mains plug not included).

CE UKCA

Item No.		
T9423USB	89H x 21W x 12D (mm)	12
T9423USBCBOX		1



Site Lights

1. High powered site light with adjustable LED.
2. Heavy duty IK08 rated design for increased impact resistance
3. Tactile on/off switch with +/- brightness function.
4. CKlearView LED for accurate colour rendering.



Site Lights



COB Power Tool Battery Site Lights

High powered site light with adjustable LED. Heavy duty IK08 rated design for increased impact resistance. Tactile on/off switch with +/- brightness function. CKlearView LED for accurate colour rendering. 4 x selectable power output (5000, 3750, 2500 and 1250lm). Integrated pivot stand to adjust working angle. IP65 rated against dust and water ingress. Threaded base for tripod mounting. Battery level indicator. Compatible with standard 18V power tool batteries using the included adaptors (eg. Bosch, Dewalt, Makita, Metabo and Milwaukee).

Item No.	i	📦
T9740	5000lm	2
T9741	10000lm	2



10W Rechargeable Site Light

High Power COB LED. 700 Lumens /colour temp 6500 Kelvin. 2 Lighting modes: High, Dimmed. Battery life: High: 2.5hrs, Dimmed: 4hrs. 3 hours approximate charge time. 360° adjustable head directs the light where you need it. Impact resistant, tested to IK05. Water & dirt resistant, tested to IP65. Including rechargeable 3.7V 2200mAh Li-Ion battery. EMC, RoHS, WEEE

Item No.	📦
T9735USB	1



Head Torches



Wide Field Headlight

The C.K T9630 USB head light is ideal for the end user working in dark & confined spaces where quality of light is important. COB LED Technology. 400 Lumens, 5,700K and CRI 80. 4 mode operation: Spot Light / Wide Field / Full Beam / Dipped Beam. Rear Flashing Red Light. Up to 6 Hours Runtime. Charge Time: 3 hours. IP-54 Rated. IK-07 Impact Rated. Charging Indicator Light.

EMC, RoHS, WEEE, IP54

Item No.	
T9630USB	50



Head Torch with Rear Red Light

High Power 150 Lumen Cree XP-G LED. 3 Lighting modes: high, dimmed, red. Rear red LED safety light. Adjustable head lamp swivels though 80°. Water & dirt resistant, tested to IPX0. Detachable over-head elasticated strap. Battery life: high - 6hrs, dimmed - 12hrs. Battery 3 x AAA (Not supplied).

EMC, RoHS, WEEE, IP54

Item No.	i	
T9612	150Lm	3



Head Torch with Motion Sensor

T9613: High Power Cree LED. 220 Lumens. 7 Lighting modes: High, Dimmed, Red, COB, COB & Main, COB & Low Light, COB & Red Beam. Battery life: High: 4hrs, Low: 9hrs, Red beam: 5hrs, COB: 9hrs, Main & COB: 135 minutes. Sensor mode switching ability. Adjustable head lamp swivels through 80°. Impact resistant, tested to IK05. Water & dirt resistant, tested to IPX4. Maximum range: 90m. Battery 3 x AAA (Not supplied). T9613USB: High Power Cree LED. 270 Lumens. 7 Lighting modes: High, Dimmed, Red, COB, COB & Main, COB & Low Light, COB & Red Beam. Battery life: High: 4hrs, Low: 9hrs, Red beam: 6hrs, COB: 9hrs, Main & COB: 135 minutes. Sensor mode switching ability. Adjustable head lamp swivels through 80°. Impact resistant, tested to IK05. Water & dirt resistant, tested to IPX4. Maximum range: 90m. Including high performance 3.7V 1800mAh Lithium-Ion rechargeable battery, USB cable.

EMC, RoHS, WEEE, IPX4

Item No.	
T9613	1
T9613USB	1



Beanie Hat - USB Rechargeable

Stylish Beanie hat with integrated USB rechargeable 80 Lumen head torch.

EMC, RoHS, WEEE

Item No.	
T9608BHR	10



LED Head Torch USB - Twin Pack

SMD LED Technology. 80 Lumens. Light modes: High / Medium / Low. Runtime: High: 2 hours, Medium: 3 hours, Low: 4 hours. Charge Time: 3.5 hours. Impact resistance: 1m. Maximum Range Distance: 10m. Battery: 3.7V 300mAh Li-ion.

EMC, RoHS, WEEE

Item No.	
T9608R2	1



CK MAGMA



Technicians Rucksacks	190
Tool Bags	191
Tool Cases	192
Tool Totes	194
Tool Rolls	196
Folders	196
Tool Belts & Accessories	196
Tool Vests & Rigs	199

TECHNICIAN'S RUCKSACK PLUS

Perfect if you have to travel distances without your van, climb or simply need to have a professional profile.



1 100% waterproof and crack-proof contoured base



2 Lockable zip for extra security on the move



3 Vertical storage pockets for easy tool access



Technicians Rucksacks



Technicians Rucksack

Durable polyester construction. Bright red inner lining for easy visibility of stored items. Internal and external document pockets. 31 pockets and holders including fold out panels for easy tool access.

Item No.	Dimensions	Weight	Volume
MA2631	H:42cm x W:38cm x D:25cm (13")	2.6kg	4



Technicians Rucksack Plus

Contoured shape base for additional comfort. Extra comfort padding at the back and reinforced shoulder straps. 39 pockets and holders including space in the base for larger tools. Padded front storage pocket for sensitive equipment/iPad and A4 Notepad.

Item No.	Dimensions	Weight	Volume
MA2635	H:47cm x W:40cm x D:20cm (16")	2.2kg	4



Wheeled Rucksack

Convenient all-in-one rucksack and wheeled tool case: Rugged & durable for all terrain use. Extra comfort padding with storable shoulder straps. Vertical pockets for easy tool access. Balanced design remains upright when fully open. Removable wheel cover to protect clothing. Durable polymer base.



Item No.	Dimensions	Weight	Volume
MA2654	H:55cm x W:38cm x D:24cm	3.9kg	2

Tool Bags



Mini Bag



Durable reinforced polyester construction with extra wide opening mouth for easy access. 100% waterproof and crackproof polymer base. Padded handle and shoulder strap for maximum comfort. Long handles; can be carried open. Internal storage area with 19 additional pockets & holders.

Item No.			
MA2627A	H:28cm x W:42cm x D:28cm (17")	1.7kg	6



Maxi bag

Durable reinforced polyester construction with extra wide opening mouth for easy access. Long handles; can be carried open. Internal storage area with 22 additional pockets & holders.

Item No.			
MA2628A	H:30cm x W:55cm x D:33cm (20")	2.2kg	6

MAXI BAG

Ideal storage solution to carry large amount of tools featuring an extra wide open mouth design which allows for easy access to tools.



1 Padded handle and shoulder strap for maximum comfort



2 100% waterproof and crackproof polymer base



3 Wide mouth opening 14"



TECHNICIAN'S TOOL CASE PLUS

Featuring a 100% waterproof, rubber base designed to keep tools / documents protected and dry, the Technician's Tool Case Plus is a unique storage solution specifically designed with the technician in mind, including fold out panels for easy tool access.



1 100% waterproof and crackproof rubberised base



2 Padded handle and shoulder strap for maximum comfort



3 Pockets and holders including fold out panels for easy tool access



Tool Cases



Technicians Tool Case

Durable polyester construction. Bright red inner lining for easy visibility of stored items. 50 pockets and holders including fold out panels for easy tool access. Padded handle and shoulder strap for maximum comfort. Padded central compartment fits laptop. Internal document pocket.

Item No.			
MA2630	H:33cm x W:46cm x D:21cm (17")	2.925kg	6



Technicians Tool Case Plus

Durable polyester construction. Bright red inner lining for easy visibility of stored items. 50 pockets and holders including fold out panels for easy tool access. Padded central compartment fits laptop. Internal document pocket.

Item No.			
MA2632	H:42cm x W:46cm x D:21cm (17")	3.9kg	6



Toolcase Plus

A place for every tool and every tool in its place! The Pro Tool Case Plus is the ultimate bag to organise and protect your tools. It features multiple vertical storage pockets, offering easy access to tools and perfect organisation of your tool bag. Dual side, wide opening storage. Heavy duty, pierce protected zips. Over 60 pockets and holders for organisation. 100% rubberised water and crackproof base. Tough 600D polyester construction.

Item No.			
MA2640	H:34cm x W:45cm x D:29cm	2.9Kg	4



Technicians Wheeled Toolcase

Designed to cope with all terrains and larger toolkits, the Technician's Wheeled Toolcase provides the perfect solution to getting your tools to the job. Tough 600D polyester construction. Rugged and durable chassis, wheels and telescopic handle for all terrain use. Balanced design for effortless movement of larger toolkits, test equipment and power tools. Extra wide main compartment featuring a red lining for high tool visibility. 30 deep square pockets and tool holders for efficient tool storage. Zip-down front panel featuring tool and A4 document storage.

Item No.			
MA2650	H:48cm x W:43cm x D:30cm	6kg	2



Technicians Toolcase Max

Benefitting from 35% greater capacity, the Technician's Tool case Max features a wide central compartment and deep side panels.

Item No.			
MA2639	H:38cm x W:50cm x D:26cm	4.2kg	2



Technicians Pro Wheeled Case

The Technician's PRO Wheeled Case is designed to store more than ever before and provides the perfect solution to effortlessly getting your tools to the job. Rugged and durable chassis, wheels and telescopic handle for all terrain use. 50 deep square pockets & tool holders for efficient tool storage. Balanced design for effortless movement of larger toolkits, test equipment and power tools. Extra wide main compartment featuring a red lining for high tool visibility. Zip down front panel featuring Tool and A4 document storage. Tough 600D polyester construction.

Item No.			
MA2652	H:43cm x W:47cm x D:29cm	6.3kg	2



Test Meter Case

Bright red inner lining for easy visibility of stored items. Adjustable padded compartments. Convenient tool kit storage. Handle and padded shoulder strap.

Item No.	Dimensions	Weight	Volume
MA2638	H:18cm x W:35cm x D:24cm (14")	1.8kg	3



Test Equipment Case Plus

Improved access with easy-opening lid and two retaining straps. Adjustable padded compartments for safe storage of test equipment and accessories. 27 pockets and holders for extensive storage of test equipment, accessories and tools. Convenient toolkit storage compartment. Carrying handle and padded shoulder strap for maximum comfort. Heavy duty lockable zip system for extra security. Hard protective divider between tools and test equipment. Integrated trolley strap, for easy transport with any Magma wheeled Case. 100% Waterproof Polymer base for increased durability. Convenient see through document/instruction manual pocket.

Item No.	Dimensions	Weight	Volume
MA2641	H:22cm x W:36cm x D:24cm	1.9kg	4

Tool Totes



Tool Tote

Durable polyester construction. Bright red inner lining for easy visibility of stored items. 100% waterproof and crackproof rubberised base. Convenient detachable handle and padded shoulder strap for maximum comfort. Roll-up cover. Large internal storage area with 32 additional pockets & holders.

Item No.	Dimensions	Weight	Volume
MA2634	H:44cm x W:49cm x D:29cm (17")	2.8kg	6



Technicians Tote



Durable polyester construction. Bright red inner lining for easy visibility of stored items. 100% waterproof and crackproof rubberised base. Convenient detachable handle for maximum comfort. Roll-up cover. Large internal storage area with 27 additional pockets & holders.

Item No.	Dimensions	Weight	Volume
MA2633	H:39cm x W:29cm x D:30cm (10")	1.6kg	6



3in1 Tote

Wipe clean removable base. 8 Vertical storage pockets for easy tool access. Rugged polyester construction.

Item No.			
MA2637	H:44cm x W:30cm x D:30cm	1.4kg	10



18" Open Tool Tote

12 vertical storage pockets for easy tool access. 100% waterproof and crackproof polymer base. Rugged polyester construction. Rigid frame including a heavy duty steel handle bar. Padded shoulder strap for maximum comfort. Large internal storage area with 33 additional pockets and holders. Adjustable straps to secure an aluminium level.

Item No.			
MA2636	H:52cm x W:28cm x D:35cm (18")	3.9kg	6

3 IN 1 TOTE

Unique three in one Tote for complete versatility, featuring an insert for storage of silicon, glues, mastic and gun.



1 Folds flat for easy storage



2 Tool tote with 8 vertical storage pockets



3 Caulking caddy: 9 dividers for silicone and sealants



Tool Rolls



Tool Roll

Durable polyester construction. Bright red inner lining for easy visibility of stored items. 30 pockets to carry a range of tools. Can be used as roll or for wall hanging. Padded handle.

Item No.			
MA2718	H:40cm x W:57cm x D:3cm	585g	3



Chisel Roll

Durable polyester construction. Bright red inner lining for easy visibility of stored items. Stores up to 9 chisels. Padded handle.

Item No.			
MA2719	H:37cm x W:52cm x D:2cm	312g	3

Folders



Contractor Organiser

Made from durable 600 denier polyester and rubberised PVC material. Strong zip around construction to protect contents. Extra slide-in pockets for organising paper work and documents. Complete with 4-ring binder mechanism for portable filing. Convenient interior segmentation with an A4 portrait pad, business card compartments and dual pen holder.

Item No.			
MA2600	H:34cm x W:30cm x D:4cm	960g	20
MA2610	H:25.5cm x W:20cm x D:5cm	420g	20

Tool Belts & Accessories



Compact Padded Belt

Tough heavy-duty construction padded toolbelt for durability and comfort. Fully adjustable from 31" to 45" (80 to 115 cm). Heavy duty quick release buckle for easy attachment/removal.

Item No.			
MA2734	H:8cm x W:103cm x D:2cm	169g	3



Toolbelt Set

The padded toolbelt set is manufactured from durable polyester, offers extra comfort and has a securing clip to stop the belt pulling through loops when loaded. Includes Padded Belt, Tool Pouch (MA2736) and Drill Holster (MA2737).

Item No.			
MA2738	H:50cm x W:30cm x D:20cm	1125g	8



Essential Pouch

Durable polyester construction. Mini pouch for essential tools. Metal clip for strength and easy attachment/removal. 4 pockets & holders for tools & equipment.

Item No.			
MA2724	H:20cm x W:9cm x D:10cm	127g	3



Universal Pouch

Over 10 easy access vertical pockets/holders for safe and organised work. Can be securely belt mounted or used separately with carrying handle. Cut proof plastic reinforced knife pocket. Hammer loop can be clipped onto either side of the pouch for right or left handed use. Adhesive tape and tape measure storage clip.

Item No.				
MA2736	H:26.5cm x W:22.50cm x D:9cm	575g	12	



Nail Pouch

Durable polyester construction. Reinforced pocket for maximum durability. Fits all C.K Magma belts or any other belts up to 3" (75mm) wide.

Item No.				
MA2733	H:26cm x W:23cm x D:5cm	100g	3	



Universal Drill Holster

Universal design for right or left handed use. Secure and accessible drill and bit pockets. Velcro securing strap for all drill types.

Item No.				
MA2737	H:34.5cm x W:18cm x D:3.5cm	195g	50	

TOOLBELT SET

Manufactured from durable polyester and offers an ideal solution for any tradesman working on site or domestically.

1 Padded belt



3 Builder's tool pouch



2 Mobile phone holder





4 Drill holster





Mobile Phone Pouch

Padded to protect your smart phone in the most rigorous working conditions. Flexible construction securely accommodates the latest generation of mobile phones. Strong spring metal clip for strength and security yet offering easy attachment/removal.

Item No.			
MA2741	H:14.5cm x W:3cm x D:8.5cm	100g	48



Knife Holder



Cut proof plastic reinforced pocket for protection and durability. Convenient storage for spare blades. Strong belt clip to hook onto trousers/belt or belt loop to allow use with tool belts up to 3" (75mm) wide. Suitable for most common trimming knives.

Item No.			
MA2731	H:7cm x W:8.3cm x D:6.7cm	83g	3



Hammer Loop



Swivel hammer loop keeps hammer vertical. Metal clip for strength and easy attachment/removal.

Item No.			
MA2721	H:17cm x W:11.5cm x D:8cm	172g	3



Tape Measure Holder



Strong metal hook for easy attachment/removal of tape. Strong belt clip to hook onto trousers/belt or belt loop to allow use with tool belts up to 3" (75mm) wide. Convenient pen/pencil holder. Suitable for 3m, 5m and 8m tape measures.

Item No.			
MA2732	H:17cm x W:11.5cm x D:2.5cm	86g	3



3 Pocket Pack

Tough see-through rear panel for clear visibility of contents. Ideal for safely storing all those loose items you need to keep in one place. Can be clipped onto belt & bag.

Item No.			
MA2740	S:15.5 x 12.5cm M:18.5 x 15.5cm L:23 x 17.5cm	157g	48



Braces

Durable polyester construction. Provides additional support for weight of loaded toolbelt plus extra storage. Fully adjustable. Mesh lining for comfort and breathability.



Item No.			
MA2727	H:59cm x W:30cm x D:4cm	376g	3

Tool Vests & Rigs



Technicians Vest



Durable polyester construction. 14 pockets & holders for tools, equipment & mobile phone. Fully adjustable. Reflective strip for visibility on site. Mesh lining for comfort and breathability.

Item No.			
MA2729	H:65cm x W:50cm x D:6cm	1.4kg	1



Belt Conversion Kit

Converts belt to be compatible with C.K Magma braces.

Item No.			
MA2730	H:11.5cm x W:3cm x D:0.7cm	56g	3



GHT
GENUINE HICKORY

GHT
14LB
AV03032

avt

Pliers & Cutters	202
Screwdrivers	203
Power Tool Accessories	203
Building & Decorating	204
Striking Tools	206
Sawing, Cutting & Filing	207
Automotive & Engineering	208
Marking & Measuring	209
PPE	210
Lighting	211

Pliers & Cutters



Insulated Pliers Set

Hardened and tempered jaws for lasting durability. For live working up to 1,000V. Soft grip handles for increased comfort. CONTENTS: 1 x Combination Plier - 180mm (7"), 1 x Side Cutter - 160mm (6") & 1 x Long Nose Pliers - 200mm (8").

IEC 60900 2018 VDE 0682-201 2019 04

Item No.	i	📦
AV06051	Set of 3	4



Side Cutters

For cutting up to 2mm Ø medium hard wire. Hardened and tempered jaws for lasting durability. Soft grip handle for increased comfort.

Item No.	↔	📦
AV06010	180mm (7")	6



Combination Pliers

For gripping, bending, twisting and cutting metal. Hardened and tempered jaws for lasting durability. Soft grip handle for increased comfort.

Item No.	↔	📦
AV06020	200mm (8")	6



Waterpump Pliers

Adjustable jaws for multiple applications. Hardened and tempered jaws for lasting durability. Soft grip handle for increased comfort.

Item No.	↔	📦
AV06030	250mm (10")	6



Multi-Purpose Snips

Suitable for cutting a variety of different materials including: soft wire, cable, rubber, carpet, plastic, leather and tin sheet. Stainless steel blades for maximum corrosion resistance. Safety catch keeps the blades together for safe storage.

Item No.	📦
AV06040	6

Screwdrivers



Insulated Screwdriver Set

Chrome vanadium blades for extra strength. Soft grip handles for increased comfort. For live working up to 1,000V. CONTENTS: 2 x PZ, sizes: 1 x 80 & 2 x 100mm, 3 x slotted, sizes: 3 x 75, 4 x 100 & 5.5 x 125mm. IEC60900

Item No.	i	📦
AV05050	Set of 5	4



Screwdriver Sets

Chrome vanadium blades for extra strength. Soft grip handles for extra comfort.

Item No.	i	📦
AV05011	Set of 4	5
AV05015	Set of 7	5



Precision Screwdriver Set

Swivel tops for fingertip control. Hardened and tempered steel blades for lasting durability. CONTENTS: 4 x slotted, sizes: 1.4, 2.0, 2.4 & 3mm. 2 x PH, sizes: 0 and 1.

Item No.	i	📦
AV05010	Set of 6	6



Stepless Ratchet Screwdriver

Ratchet handle with forward and reverse selector for additional control. Cam-drive stepless ratchet for a smoother, more comfortable action.

Item No.	↔	📦
AV05020	45mm (1 3/4")	6



Stepless Ratchet Driver Set

Ratchet handle with forward and reverse selector for additional control. Cam-drive stepless ratchet for a smoother, more comfortable action. Bits store in handle for easy access. CONTENTS: Ratchet driver with 1/4 hexagon drive magnetic holder. Assorted screwdriver bits: 2 x slotted 3 x PH and 3 x PZ.

Item No.	↔	📦
AV05021	100mm (4")	6

Power Tool Accessories



Masonry Drill Bit Sets

Impact resistant tungsten carbide tips.

Item No.	↔	📦
AV08010	4, 5, 6, 8 & 10mm	6
AV08012	SDS 5, 6, 7, 8 & 10mm	5
AV08014	SDS 12, 16, 24 x 1000mm	6
AV08015		6



HSS Drill Bit Set

For drilling through metal. Precision ground for greater accuracy. CONTENTS; 1.5, 2, 2.5, 3, 3.2, 3.5, 4, 4.5, 4.8, 5, 5.5, 6 & 6.5mm.

Item No.	i	6
AV08011	Set of 13	6



Flat Drill Bit Set

HSS, hardened for long life performance. Brad pointed for accurate drill start. Ground wing spur for faster, cleaner cutting. Convenient wall hanging wallet. Contents each 1 piece: 13, 16, 20, 22, 25 & 32mm.

Item No.	i	20
AV08013	Set of 6	20



Angle Driver

Slim design allows power drilling/driving in confined spaces. 1/4" hexagon drive chuck and shank. Suitable for use with most power drills.

Item No.	6
AV08020	6

Building & Decorating



Spring Clamps

Hinged jaws for clamping a variety of shapes.

Item No.	100mm (4")	6
AV12010	100mm (4")	6
AV12011	150mm (6")	6
AV12012	230mm (9")	6



Pointing Trowel

Hardened and tempered blade for lasting durability. Soft grip handle for increased comfort.

Item No.	150mm (6")	6
AV04020	150mm (6")	6



Broad Heel Brick Trowel

Hardened and tempered blade for lasting durability. Soft grip handle for increased comfort.

Item No.	250mm (10")	6
AV04021	250mm (10")	6



Plasterers Trowel

Hardened and tempered blade for lasting durability. Soft grip handle for increased comfort.

Item No.		
AV04022	280mm (11")	6



Filling Knife

Hardened stainless steel blade for lasting durability.

Item No.	
AV12025	6



General Purpose Scraper

Ideal for a variety of tasks including the removal of paint, glue or putty from even surfaces. Multi-position blade for variable scraping depths. Soft grip handle for increased comfort. Blade retracts for safe storage.

Item No.	
AV12021	6



Scraper Blades

Replacement blades for Avit General Purpose Scraper (AV12021).

Item No.		
AV12020	5 pieces	12



Sealant Gun

Takes up to 400ml cartridges. Includes nozzle cleaner.

Item No.	
AV12040	6



Dust Sheet

100% cotton, for increased protection of furniture and flooring. Machine washable, re-usable and long lasting. Absorbs paint splatter for added protection.

Item No.	
AV12030	3



Collapsible Stool

This collapsible stool can be used both indoors and outdoors, making it suitable for a wide range of applications. Non-slip base. Lightweight - weighs less than 1KG so it can be carried limiting fatigue. Sturdy - supports up to 200KG/31 stone/440lbs thanks to the fish scale structure which increases the mechanical strength, stability and safety. Adjustable height - height range from 6 to 46 cm in one easy movement. 12 positions can be chosen to meet your usage scenario and maximize your convenience. Easy to carry - complete with a hand strap and a shoulder strap for easy transportation in a compact portable size (25x6cm when collapsed). Multiple applications - The polypropylene material is resistant to water and wipe-clean making it suitable for use indoors and outdoors.

EN 581-1 and EN 581-2 (Except Clause 8.1)

Item No.		
AV00010	900g	12

Striking Tools



Claw Hammers - Fibreglass

Hardened and tempered head for lasting durability. Tough fibreglass damage resistant handle. Shock absorbing non-slip grip for additional safety.

Item No.		
AV03010	450g (16oz)	6
AV03011	560g (20oz)	6



Club Hammer

Hardened and tempered head for lasting durability. Tough fibreglass damage resistant handle. Shock absorbing non-slip grip for additional safety.

Item No.		
AV03020	1.1kg (2.5lb)	3



Sledge Hammers

Hardened forged steel head for strength and durability. Tough hickory shaft for high impact applications.

Item No.		
AV03030	3.2kg (7lb)	4
AV03031	4.5kg (10lb)	4
AV03032	6.4kg (14lb)	2



Wrecking Bars

Hardened high carbon steel for strength and durability.

Item No.		
AV04030	450mm (18")	12
AV04031	600mm (24")	15
AV04032	750mm (30")	12



Electricians Bolster



Hardened and tempered cutting edge for lasting durability. Impact absorbing handle offers additional comfort. Built-in hand guard for increased safety.

Item No.		
AV04010	57mm (2.25")	6



Brick Bolster

Hardened and tempered cutting edge for lasting durability. Impact absorbing handle offers additional comfort. Built-in hand guard for increased safety.

Item No.		
AV04011	100mm (4")	6



Hacksaw

For cutting metal. Wing nut adjustment for quick and easy blade tensioning. Two position blade for straight and 45° angle cuts. Rubber handle for increased grip.

Item No.		
AV09011	300mm (12")	6

Sawing, Cutting & Filing



Tri-Cut Handsaw

For cutting wood. Triple ground and hardened teeth for effortless cutting. Cuts on both the push and pull stroke for fast and smooth cuts. 45 & 90° angle guide built into handle for easy marking. Rubberised handle for extra grip.

Item No.		
AV09020	550mm (22")	6*



Mini Hacksaw

For cutting metal. Screw adjustment for quick and easy blade tensioning. Soft grip handle for extra comfort.

Item No.		
AV09010	150mm (6")	6



Coping Saw

Wings adjust blade through 360° for intricate cutting. CONTENTS: Wood cutting blades; 2 x 16tpi & 1 x 20 tpi. Metal cutting blades; 1 x 24tpi & 1 x 28tpi.

Item No.	
AV09030	6



Wood Chisel Sets

Hardened and tempered steel blades for lasting durability. Shatter resistant handles for extra safety. Steel strike plates prevent handle damage. CONTENTS: 6.5, 13, 19 & 25mm.

Item No.		
AV10010	Set of 4	6



Trimming Knife - Auto-Load

Auto load blades for increased speed and safety. 4 lockable positions for variable cutting depths. Blade retracts for safe storage.

Item No.	i	6
AV01010	with 5 blades	6



Trimming Knife - Retractable

3 lockable positions for variable cutting depths. Blade retracts for safe storage.

Item No.	i	12
AV01001		12



Trimming Knife Blades - Standard

Two notch blades suitable for most trimming knives. Complete with plastic dispenser for safe storage.

Item No.	i	6
AV01090	10 pieces	6

Automotive & Engineering



Adjustable Wrenches - Standard

Hardened and tempered jaws for lasting durability. Soft grip handle for increased comfort.

Item No.	↔	6
AV07010	200mm (8")	6
AV07011	250mm (10")	6



Socket Set

Ratchet handle with forward and reverse settings for added control. Chrome vanadium components for extra strength. CONTENTS: Ratchet handle, 75mm extension and universal joint. Spinner handle with 1/4" drive recess. Assorted sockets: 12 x metric sizes: 4, 4.5, 5, 5.5, 6, 7, 8, 9, 10, 11, 12, 13mm.

Item No.	i	4
AV07031	Set of 16	4



Socket & Bits Set

Ratchet handle with forward, reverse and lockable settings for added control. Chrome vanadium sockets for extra strength. Soft grip handle for increased comfort. CONTENTS: Ratchet driver, 1/4" drive adaptor, magnetic extension, assorted metric sockets: 7 x metric, sizes: 6, 7, 8, 9, 10, 11 & 12mm, 7 x AF sizes: 3/16, 1/4, 5/16, 11/32, 3/8, 7/16" & 1/2", assorted screwdriver bits: 3 x slotted, sizes: 3/16, 1/4 & 9/32", 3 x cross point, sizes: No.1, 2 & 3, 8 x hexagon, sizes: 1.5, 2, 2.5, 3, 4, 5, 5.5 & 6mm, 2 x square drive, sizes: 1 & 2 and 7 x TX, sizes: 10, 15, 20, 25, 27, 30 & 40.

Item No.	i	3
AV07030	Set of 40	3



Combination Spanner Set

Chrome vanadium steel for extra strength. Chrome plated for maximum corrosion resistance. CONTENTS: 7, 8, 9, 10, 11, 12, 13, 14, 15 & 16mm.

Item No.		
AV07020	Set of 10	3



Socket Box Template

For quick and accurate positioning of single and double electric socket boxes. Two integrated level vials for accurate alignment to ensure a top-quality finish. Compact size for easy storage.

Item No.	
AV02034	12

Marking & Measuring



Heavy Duty Tape Measures

Convenient tape lock for ease of use. Pause buttons for fingertip control. Heavy duty cover for maximum grip.

Item No.		
AV02010	3m (10ft)	6
AV02011	5m (16ft)	6
AV02012	7.5m (25ft)	6



Spirit Level

3 vials for measuring vertical, horizontal & 45°. Strong lightweight construction for ease of use. Grab handles for improved grip.

Item No.		
AV02031	1m (3.3ft)	6



Tape Measure

Convenient tape lock for ease of use. Self-retracting tape blade for quick and easy storage.

Item No.		
AV02001	5m (16ft)	6



Pocket Level

3 vials for measuring vertical, horizontal & 45°. Magnetic base for ease of use.

Item No.	
AV02033	6

PPE



Cover Spectacles

Lightweight design fits comfortably over most prescription spectacles. Polycarbonate construction for protection against low energy impact.

BS EN 166

Item No.	i	📦
AV13020	Clear	6



Wraparound Glasses - Anti-Mist

Anti-mist coating to prevent fogging. Frameless sports style design for distortion free vision. Cushioned temple pads for superior comfort and grip. Polycarbonate lens for protection against low energy impact.

EN166:1F

Item No.	i	📦
AV13024	Anti-Mist	5



Wraparound Glasses - Clear

Frameless sports style design for distortion free vision. Cushioned temple pads for superior comfort and grip. Polycarbonate lens for protection against low energy impact.

Item No.	i	📦
AV13021	Clear	5



Ear Defenders

Lightweight design with padded cups for all day comfort. Adjustable headband for optimum fit.

BS EN 352 1+2

Item No.	i	📦
AV13012		4



Wraparound Glasses - Tinted

Tinted lens ideal for moving between indoor and outdoor locations. Frameless sports style design for distortion free vision. -Cushioned temple pads for superior comfort and grip. Polycarbonate lens for protection against low energy impact.

EN166:1F

Item No.	i	📦
AV13022	Indoor / Outdoor	5



Hard Hat

Tough PE shell for excellent shock absorption. 6-point terylene cradle for a comfortable fit. Brushed nylon sweatband for additional comfort. Pin-lock adjustment system for a snug fit. Electrical insulation to 440v for enhanced protection.

BS EN 397:2012

Item No.	i	📦
AV13060	Full Peak, 440v	3



PU Gloves

Polyurethane coating to palm and fingers for good grip and dexterity. Seamless liner for pro-longed comfort. Superior abrasion resistance for lasting durability. Excellent tear resistance for additional protection.

EN420 Class 2, EN388

Item No.	i	📦
AV13074	Large	12
AV13075	Extra Large	12



Hi-Vis Vest

Fluorescent background and retroflective bands for intermediate protection. Hook and loop fastening for a comfortable fit. 100% polyester (PES) for durability.

BS EN ISO 20471:2013+A1:2016 BS EN ISO 13688:2013

Item No.	i	📦
AV13100	Yellow, XL only	6



Gripper Gloves

Provides protection for all manual handling tasks. Non-slip criss cross pattern provides grip in all conditions. Seamless construction for pro-longed comfort. Excellent tear resistance for additional protection.

Item No.	i	📦
AV13078	Large	12

Lighting



Nitrile Gloves

Nitrile coating to palm and fingers for excellent dry grip. Seamless liner for pro-longed comfort. Superior abrasion resistance for lasting durability. Coated area provides resistance to liquids, oil and grease.

EN420 Class 2, EN388

Item No.	i	📦
AV13072	Large	12
AV13073	Extra Large	12



Site Lamp

USB Rechargeable site light, adaptable for multiple locations and positions; flat folding, standing, hanging, ideal for workshops, cars, garages, the perfect utility light for every household. LED Source: 20W COB LED. 1500 Lumens. Light modes: High/ Dimmed/ SOS/ Flash. Runtime: High: 2.5 hours, Low: 4 hours. Charge Time: 5-6 hours. IK Rating: IK05. IP Rating: IP65. Battery: 3.7V 4400mAh, recharge via USB.

EMC, RoHS, WEEE

Item No.	📦
AV15020	1



2,5[□]

0,2-6[□] 24-10

» JOKAR

20100

6 12 18



Automatic Wire Strippers	214
Cable Strippers	216
Cable Knives	220
Quadro	224
Micro Precision Wire Strippers	224

Automatic cable/wire strippers

Fibreglass-reinforced polyamide construction for high strength and light weight.

Ergonomically designed for fatigue free, repetitive stripping.

Stripping length scale for consistent results.



Automatic Wire Strippers



Jokari Flat Cable Stripper

Automatic stripper for PVC-insulated flat twin and earth cables. Removes both the external sheathing and internal conductor insulation. A built-in wire bending hole for effective termination of conductors up to 2.5mm². No adjustments necessary. Exchangeable blades. Stripping of any length possible due to open frame construction of handles.

TÜV/GS

Item No.	mm ² / AWG	
T20030	0.75 - 2.5mm ² / 18 - 14 AWG	6
T29030A	Replacement Blades	1



Jokari Super 4 Plus

Fibreglass-reinforced polyamide construction for high strength and light weight. Ergonomically designed for fatigue free, repetitive stripping. Stripping length scale for consistent results. Designed for solid & stranded wires. Automatic wire size adjustment for convenience. Integrated wire cutter up to 2.5 mm².

TÜV/GS

Item No.	mm ² / AWG	
T20050	0.2 - 0.6mm ² / 24 - 10 AWG	6
T29050	Replacement Blades	1



Jokari AS Interface Pro

Automatic wire stripper for AS-Interface cables with PUR, TPE or FR-PVC insulation. Full protection for the internal conductors, unlimited stripping length, with optical length scale 15-18-20mm. Tested with cables from Gebauer&Griller: AS-Interface BUS 2 x 1.5mm² TPE 90301, 80479, 90302, 80489, AS-Interface BUS 2 x 1.5mm² FR-PVC 110612, 110614, AS-Interface BUS highflex 2 x 1.5mm² FR-PUR 21806, 107364, 75244, 107366, AS-Interface BUS Long Distance highflex 2 x 2.5mm² FR-PUR 143740, 143742. No adjustments required. Spare blades available.

Item No.	∅	
T20075	1.5 - 2.5mm ²	1
T29070	Replacement Blades	1



Jokari No. 6-16

Ergonomic, automatic wire stripper for solid and stranded wires. No adjustment to diameter necessary. Also suitable for stripping the sheathing of PVC-Flex 3 x 0.75mm² and solar cables with jointed cable sheathings (e.g. Solarflexi, Energyflexi). Stripping of any length possible due to open frame construction of handles. Exchangeable blades. Length scale printed on handle.

TÜV/GS

Item No.	mm ² /AWG	
T20090	6 - 16mm ² / 10 - 5 AWG	6
T29090	Replacement Blades	1



Jokari SECURA 2K

Fibreglass-reinforced polyamide construction for high strength and light weight. Ergonomically designed soft grip handles for fatigue free, repetitive stripping. Stripping length scale for consistent results. Designed for round, solid or stranded cored wire. Automatic cable size adjustment for convenience.

TÜV/GS

Item No.	mm ² /AWG	
T20100	0.2 - 6mm ² / 24 - 10 AWG	8
T29100	Replacement Blades	1



Jokari Outlet Special 20

Wire stripper for de-insulating cable sections of 20mm. Ideal for connecting monitoring systems or potential equalization purposes. Ideal for working in tight spaces, such as cable ducts. Ergonomic design enables gentle and comfortable use. Newly developed exchangeable cassette system for quick and easy blade changing.

TÜV/GS

Item No.	Ø	
T20220	7.5 - 9mmØ	1



Jokari Sensor Special

Fibreglass-reinforced polyamide construction for high strength and light weight. Ergonomically designed for fatigue free, repetitive stripping. Stripping length scale for consistent results. Designed for stripping Round standard, PUR Halogen Free Cables, Highly Flexible TPE-U-Cables, PUR-Cables, PUR / PVC Cables, PVC Cables, Multi-Stranded Cables, Shielded and Non-Shielded Cables.

TÜV/GS

Item No.	Ø	
20300	4.4 - 7mmØ	3
T29300	Replacement Blades	1



Jokari Sensor Mini

Fibreglass-reinforced polyamide construction for high strength and light weight. Ergonomically designed for fatigue free, repetitive stripping. Stripping length scale for consistent results. Designed for stripping Round standard, PUR Halogen-free Cables, Highly Flexible TPE-U-Cables, PUR-Cables, PUR / PVC Cables, PVC Cables, Multi-Stranded Cables, Shielded and Non-Shielded Cables.

TÜV/GS

Item No.	Ø	
T20310	3.2 - 4.4mmØ	5
T29310	Replacement Blades	1



Jokari High Strip

Ergonomic precision wire stripper for conductors with tough and difficult insulations such as rubber, silicone, TPE etc. Length stop adjustable from 5 - 15mm. No adjustment to diameter necessary due to fixed blade diameters. Stripping of any length possible. Exchangeable blades.

TÜV/GS

Item No.	mm ² /AWG	
T20450	0.5 - 4mm ² / 20 - 11 AWG	6
T29450	Replacement Blades	1



Jokari Special

Fibreglass-reinforced polyamide construction for high strength and light weight. Ergonomically designed for fatigue free, repetitive stripping. Stripping length scale for consistent results. Designed for solid & stranded wires. Automatic wire size adjustment for convenience. Integrated wire cutter up to 2.5mm².

TÜV/GS

Item No.	mm ² /AWG	
T20060	0.5 - 6mm ² / 20 - 10 AWG	3
T29060	Replacement Blades	1



Jokari SW11 - Top Coax

Socket SW 11mm made of high-strength, glass-fibre-reinforced plastic for tightening F-connectors (HEX11). Perfect as attachment for Jokari Top Coax Plus stripper T30110.

Item No.	
T30101	12

Cable Strippers



Jokari CAN-Strip

Stripper for Data Bus Twisted Pair Cable. For quick and easy stripping of sheathing of WF-cables. For applications in industry / aircraft industry.

Item No.	Ø	
T30013	Max. 3.5mmØ (9/64")	1



Jokari Top Coax Plus

Cable stripper for all standard coaxial cables, including TV-Coax, RG58U/RG59U, 3-core flex (3 x 0.75mm²). With integrated SW 11mm plug made of high-strength, glass-fibre reinforced plastic for tightening F-connectors (HEX 11). Integrated length scale from 5 to 20mm, unlimited stripping range. TiN-coated blades.

TÜV/GS

Item No.	Ø	
T30110	4.8 - 7.5mmØ (3/16 - 19/64")	12



Jokari Universal No. 12

Universal stripper for stripping all standard round cables, including NYM 3x1.5 to 5x2.5mm². Blades are TIN-coated blades. No cutting depth adjustments required.

TÜV/GS

Item No.	Ø	
T30120	8 -13mmØ (5/16 - 1/2")	6



JOKARI XL

For stripping all standard round cables (e.g. NYM 3 x 1.5mm to 5 x 2.5mm²) in deep branch and device boxes. Long design for easy access and improved power transmission for cable processing directly on the back wall of the box. Razor sharp four-blade arrangement for fast, precise and damage free stripping. Cable feeds within the product so precise cutting depth is not required. The soft touch grip for secure comfortable operation. To use: Release the locking catch. Open the cable stripper and insert the cable. Close the cable stripper and rotate 1/4 turn to the right and 1/4 turn to the left. Bend the cable slightly and pull off the sheathing.

TÜV/GS

Item No.	Ø	
T30125	8 - 13mmØ (5/16 - 1/2")	12



Cable strippers

Razor sharp, preset stripping blades for fast, precise and damage free stripping of round cables.

Retractable trimming knife blade for convenience.

Titanium-Nitride coated blades for increased durability.



Jokari Strip No. 14

For cable stripping of common round cables and flat cables. With stripping device for single solid and stranded wires. Including blade for length cut. Pocket clip.

TÜV/GS

Item No.	i	☐
T30140	Max. 12mm (1/2")	6



Jokari SECURA No. 15

Razor sharp, preset stripping blades for fast, precise and damage free stripping of round cables. Pre-set precision stripping blades for damage free conductor stripping. Retractable trimming knife blade for convenience. Titanium-Nitride coated blades for increased durability.

TÜV/GS

Item No.	∅	☐
T30155	8 - 13mm∅ (5/16 - 1/2")	6



Jokari PC-Strip

Special sheathing and insulation stripping tool for PVC-insulated datacommunications and control cables. Blades with special Titanium-Nitride coating (TIN) to achieve longer life, faster cutting and less wear. No adjustment of cutting depth necessary. Wire stripping range 0.2 - 4.0mm². With pocket clip.

TÜV/GS

Item No.	∅	☐
T30160	5 - 13mm∅ (3/16 - 5/8")	6





Jokari PC-CAT

Special sheathing and insulation stripping tool for PVC-insulated CAT and twisted pair cables. Blades with special Titanium-Nitride coating (TIN) to achieve longer life, faster cutting and less wear. No adjustment of cutting depth necessary. Wire stripping range 0.2 - 0.8mm². With pocket clip. TÜV/GS

Item No.	∅	
T30161	4.5 - 10mm∅ (3/16 - 3/8")	1



Jokari AS-Interface Strip

Stripping tool for AS-Interface cable with rubber outer sheath. Special designed blades. Additional stripping device for 1.5mm² wires. TÜV/GS

Item No.	
T30300	1



Jokari UNI-Plus

For quick, precise cable stripping of common round cables. No adjustment of cutting depth necessary. Length stop changeable for left and right-handed use. Additional stripping device for 1.5² and 2.5² wires. TÜV/GS

Item No.	∅	
T30400	8 - 15mm∅ (5/16 - 19/32")	12



Jokari No.1-Cat

Powerful stripping tool for PVC-insulated data cables. Blades are titanium-nitride coated. Unique blade layout lifts the outer insulation carefully and strips the foil shielding. No adjustment to the cutting depth necessary. Including length scale. TÜV/GS

Item No.	∅	
T30500	4.5 - 10mm∅ (3/16 - 3/8")	12



Jokari SECURA Coaxi No. 1

Razor sharp, preset stripping blades for fast, precise and damage free stripping of all common coaxial cables. TV-Coax, RG 58 / RG 59, PVC-Flex 3 x 0.75mm². Visible 20mm length scales. Cutting blades on both ends of the tool are marked with 1 and 2 for the correct order of use. TÜV/GS

Item No.	∅	
T30600	4.8 - 7.5mm∅ (3/16 - 19/64")	18



Jokari Fibre Strip DC

Stripping tool Fibre Optic Cables e.g. for DAC-Direct-Access Cable. Blades are titanium-nitride coated. No adjustment to the cutting depth necessary.

Item No.	∅	
T30700	Max. 5.9mm∅	12



Jokari Fibre Strip LC

Stripping tool to cut the outersheath of distribution cables. With durable and ergonomically designed pocket clip. TÜV/GS

Item No.	∅	
T30800	∅ 8.2mm∅ (21/64")	1



Jokari LC-PUR

For separating the outer sheath by bilateral longitudinal cut for round cables. Suitable for cable wall thicknesses of approx. 1mm. Pocket clip. Body made of high quality, wear-resistant polyamide.

Item No.	Ø	Icon
T30810	6mmØ (15/64")	1



Jokari SE-Strip 1.5mm

For all common security and energy cables, e.g. halogen-free cables, flame-retardant cables, solar cables, short-circuit and earthing protection cables, NSGAFÖU, VER H07RN-F, electrical engineering, electrical industry, chemical oil industry, petro chemistry, solar industry. Insulation Stripping Tool for security and energy cables. No adjustment of cutting depth necessary. Including series wire stopper / length scale 8 -10 -12mm. With pocket clip.

TÜV/GS

Item No.	Ø	Icon
T30180	1.5mm ² / 7mmØ (1/4")	12



Jokari Allrounder

Stripper for round and flat cables. A tool with a various range of applications from building services to industrial use. Extra blade for longitudinal cut. 2 stripping notches with length stop for stripping conductors. The removable length stop is suitable for left and right hand use and can be stored in the tool handle.

TÜV/GS

Item No.	Ø	Icon
T30900	4 - 15mmØ (5/32 - 1/2")	12



Jokari SE-Strip 2.5 - 6mm

For all common security and energy cables, e.g. halogen-free cables, flame-retardant cables, solar cables, short-circuit and earthing protection cables, NSGAFÖU, VER H07RN-F, electrical engineering, electrical industry, chemical oil industry, petro chemistry, solar industry. Insulation Stripping Tool for security and energy cables. No adjustment of cutting depth necessary. Including series wire stopper / length scale 8 - 10 - 12mm. With pocket clip.

TÜV/GS

Item No.	Ø	Icon
T30190	2.5 - 6mm ² / 7.5 - 9.5mmØ (5/16 - 3/8")	12



Jokari Locator Box

Accessory kit for cable stripper Allrounder and UNI-PLUS. Contains 4 depth stops. Covers diameters: 4 - 11.9mm. Depth stops colour coded for easy identification. Suitable for mounting on a key chain. Storage in the handle of the cable stripper. Defining the blade spacing for a permanent and safe working process.

Item No.	Icon
T30910	1



Jokari SE-Strip 11 - 13mm

For all common security and energy cables, e.g. halogen-free cables, flame-retardant cables, solar cables, short-circuit and earthing protection cables, NSGAFÖU, VER H07RN-F, electrical engineering, electrical industry, chemical oil industry, petro chemistry, solar industry. Insulation Stripping Tool for security and energy cables. No adjustment of cutting depth necessary. Including series wire stopper / length scale 8 - 10 - 12mm. With pocket clip.

TÜV/GS

Item No.	Ø	Icon
T30200	10 & 16mm ² / 11 & 13mmØ (7/16 - 1/2")	12



Cable knives

Cutting blade automatically repositions from cutting around and cutting along the sheath for fast and damage free stripping.

High grade wear resistant polyamide construction.

Spare cutting blade in handle.



Cable Knives



Jokari No. 16 SECURA

Cutting blade automatically repositions from cutting around, to cutting along the sheath for fast and damage free stripping. Adjustable cutting depth to prevent damage to the conductors. High grade wear resistant polyamide construction. Slip-proof handle grip with soft thumb protector. Cutting blade with Titanium-Nitride coating (TIN) to achieve longer life, faster cutting and less wear. Spare cutting blade with TIN coating in the handle.

TÜV/GS

Item No.	Ø	Icon
T10160	4 - 16mmØ (5/32 - 5/8")	6



Jokari No. 16 Standard

For stripping all standard round cables. Knives with special Titanium-Nitride coating (TIN) to achieve longer life, faster cutting and less wear. The large adjustment screw allows for effortless adjustments. Automatic adjustment from round to length cut. Included TIN coated spare blade in the handle.

TÜV/GS

Item No.	Ø	Icon
T10162	4 - 16mm Ø (5/32 - 5/8")	1



Jokari No. 27 SECURA

Cutting blade automatically repositions from cutting around, to cutting along the sheath for fast and damage free stripping. Adjustable cutting depth to prevent damage to the conductors. High grade wear resistant polyamide construction. Slip-proof handle grip with soft thumb protector. Cutting blade with Titanium-Nitride coating (TIN) to achieve longer life, faster cutting and less wear. Spare cutting blade with TIN coating in the handle.

TÜV/GS

Item No.	Ø	Icon
T10270	8 - 28mmØ (5/16 - 1.1/8")	6



Jokari No. 27 Standard

For stripping all standard round cables. The large adjustment screw allows for effortless adjustments. Knives with special Titanium-Nitride coating (TIN) to achieve longer life, faster cutting and less wear. The large adjustment screw allows for effortless adjustments. Automatic adjustment from round to length cut. Including TIN coated spare blade in the handle.

TÜV/GS

Item No.	Ø	Icon
T10272	8 - 28mmØ (5/16 - 1.1/8")	1



Jokari No. 28H Standard

Cutting blade automatically repositions from cutting around, to cutting along the sheath for fast and damage free stripping of round cables. Suitable for round multicore cables for fixed installation, Flexible cables, Damp-proof installation cables e.g NYM, NYY. Adjustable cutting depth to prevent damage to the conductors. High grade wear resistant polyamide construction - light and strong. Knives Titanium-Nitride coated (TIN) for a longer life, faster cutting and less wear. With TIN coated hooked blade and protection cap. Including TIN coated spare blade in the handle. Spare cutting blade in the handle.

Item No.	Ø	Icon
T10282	8 - 28mmØ (5/16 - 1.1/8")	18



Jokari No. 28H SECURA

Cutting blade automatically repositions from cutting around, to cutting along the sheath for fast and damage free stripping. Adjustable cutting depth to prevent damage to the conductors. High grade wear resistant polyamide construction - light and strong. Additional external hook & straight blade. Slip-proof handle grip with soft thumb protector. Cutting blade with Titanium-Nitride coating (TIN) to achieve longer life, faster cutting and less wear. Spare cutting blade with TIN coating in the handle.

Item No.	Ø	Icon
T10280	8 - 28mmØ (5/16 - 1.1/8")	6



Jokari No. 28G Standard

For stripping all standard round cables. Knives with special Titanium-Nitride coating (TIN) to achieve longer life, faster cutting and less wear. The large adjustment screw allows for effortless adjustments. Automatic adjustment from round to length cut. Including TIN coated spare blade in the handle. With TIN coated straight blade.

Item No.	Ø	Icon
T10285	8 - 28mmØ (5/16 - 1.1/8")	1



Jokari No. 28G SECURA

For stripping all standard round cables. Knives with special Titanium-Nitride coating (TIN) to achieve longer life, faster cutting and less wear. The large adjustment screw allows for effortless adjustments. Automatic adjustment from round to length cut. User benefits from a secure grip achieved by the non-slip padding. Including TIN coated spare blade in the handle. With TIN coated straight blade.

Item No.	Ø	Icon
T10281	8 - 28mmØ (5/16 - 1.1/8")	18



Jokari No. 35

Cutting blade automatically repositions from cutting around, to cutting along the sheath for fast and damage free stripping of round cables. Suitable for most common round multicore cables. High grade wear resistant polyamide construction. Knives Titanium-Nitride coated (TIN) for a longer life, faster cutting and less wear. Including TIN coated spare blade in the handle.

Item No.	Ø	Icon
T10350	27 - 35mmØ (1.5/64 - 1.1/2")	12



Jokari No. 35P

For stripping paper insulated cables. Knives with special Titanium-Nitride coating (TIN) to achieve longer life, faster cutting and less wear. The large adjustment screw allows for effortless adjustments. Automatic adjustment from round to length cut. User benefits from a secure grip achieved by the non-slip padding. Including TIN coated spare blade in the handle.

Item No.			
T10355	35 - 300mm ² / insulation 3 - 5mm		1



Jokari No. 50

Cutting blade automatically repositions from cutting around, to cutting along the sheath for fast and damage free stripping of round cables. Suitable for most common round multicore cables. High grade wear resistant polyamide construction. Knives Titanium-Nitride coated (TIN) for a longer life, faster cutting and less wear. Included TIN coated spare blade in the handle.

TÜV/GS

Item No.	∅		
T10500	35 - 50mm∅ (1.3/8 - 1.15/16")		12



Jokari No. 70

Cutting blade automatically repositions from cutting around, to cutting along the sheath for fast and damage free stripping of round cables. Suitable for most common round multicore cables. High grade wear resistant polyamide construction - light and strong. Knives Titanium-Nitride coated (TIN) for a longer life, faster cutting and less wear. Including TIN coated spare blade in the handle. Spare cutting blade in the handle.

TÜV/GS

Item No.	∅		
T10700	50 - 70mm∅ (1.31/32 - 2.3/4")		12



Jokari Spare Cable Blade

Suitable for all Jokari Cable Knife versions. Knife Titanium-Nitride coated (TIN) for a longer life, faster cutting and less wear.

Item No.	i	
T19000	Single	1
T19000/3	Set of 3	80



Jokari Cable Knife System 4-70

Safety - Cut injuries are a thing of the past with the newly developed protection mechanism. Modular System - Thanks to the intelligent bracket change system, all common cable types, from 4 to 70mm diameter, can be stripped with just one tool. Design - The cutting can be monitored instantly through the unique a sight window in the metal bracket. The perfect ergonomic design of the new JOKARI ensures comfortable handling.

TÜV/GS

Item No.	∅	
T70000	4 - 70mm∅ (0.16 - 2.75")	10



Jokari Cable Knife 4-70 Set

Cable Knife System. Brackets can be changed for different cable diameters. For round cables, for flexible and fixed installation, installation cable (indoor and outdoor). Including small window in the bracket to see the knife stripping the insulation. CONTENTS: Cable knife including 5 brackets covering the following capacities: 4 - 16 / 8 - 28 / 27 - 35 / 35 - 50 and 50 - 70mm∅ (5/32 - 2.3/4").

TÜV/GS

Item No.		
T71000		10



Jokari Cable Bracket No. 16

Bracket for Jokari System 4-70 for stripping all standard round cables from 4 - 16mmØ (5/32 - 5/8").

Item No.	
T79016	1



Jokari Cable Bracket No. 50

Bracket for Jokari System 4-70 for stripping all standard round cables from 35 - 50mmØ (1.3/8 - 1.15/16").

Item No.	
T79050	1



Jokari Cable Bracket No. 28

Bracket for Jokari System 4-70 for stripping all standard round cables from 8 - 28mmØ (5/16 - 1.1/8").

Item No.	
T79028	1



Jokari Cable Bracket No. 70

Bracket for Jokari System 4-70 for stripping all standard round cables from 50 - 70mmØ (1.31/32 - 2.3/4").

Item No.	
T79070	1



Jokari Cable Bracket No. 35

Bracket for Jokari System 4-70 for stripping all standard round cables from 27 - 35mmØ (1.5/64 - 1.1/2").

Item No.	
T79035	1



Jokari Spare Hook Blade

Replacement hook blade, suitable for Jokari Cable Knife System 4-70.

Item No.	
T79055	1

Quadro



Jokari QUADRO Plus

QUADRO - the unmatched integration of four key functions: cutting - insulation stripping - twisting - crimping, with integrated locking mechanism to ensure an even, high-quality connection, the perfect synthesis of ergonomics and functionality for fast and precise crimping of connector sleeves in strip form. The integrated locking mechanism releases when the crimp stamp has reached the final position. Quick reloading of connector sleeves by switching magazines enables fast and efficient work with no adjustment necessary for different cross-sections. Working range: wires with insulation made of PVC from 0.5 to 2.5mm² (AWG 20 - 14). Wire stopper for perfect length. No adjustment necessary for different cross-sections. Twisting prevents the splaying of wire strands to enable easy insertion in connector sleeves. Crimping of insulated ferrules from sizes 0.5 - 2.5mm² (AWG 20 - 14). CONTENTS: 1 Multifunction Plier Quadro, 3 magazines with end sleeve strips in 0.5 / 0.75 / 1.0 / 1.5 and 2.5mm². TÜV/GS VDE 0609 Part 1

Item No.	i	☐
T62000	Set	1
T60100	Magazine	1



Jokari Ferrules

Ferrule strips for the Jokari QUADRO Plus.

Item No.	i	☐
T60150	0.5mm	1
T60175	0.75mm	1
T60110	1mm	1
T60115	1.5mm	1
T60125	2.5mm	1

Micro Precision Wire Strippers



Jokari SWS-PLUS 012

Micro-Precision stripping tool for cable stripping of solid and stranded wires. With adjustable length stopper up to 15mm. Integrated cutter for wire diameters of up to 0.8mmØ. TÜV/GS

Item No.	∅	☐
T40015	0.12mmØ / 36 AWG	1



Jokari PWS-PLUS 001

Micro-Precision stripping tool for cable stripping of solid and stranded wires. Working range 0.12-0.16-0.20-0.25-0.30-0.40mmØ. With adjustable length stopper from 1.5 to 22mm. Integrated cutter for wire diameters of up to 0.8mmØ. TÜV/GS

Item No.	∅	☐
T40024	0.12 - 0.40mmØ / 36 - 26 AWG	1



Jokari PWS-PLUS 002

Micro-Precision stripping tool for cable stripping of solid and stranded wires. Working range 0.25-0.30-0.40-0.50-0.60-0.80mmØ. With adjustable length stopper from 1.5 to 22mm. Integrated cutter for wire diameters of up to 0.8mmØ. TÜV/GS

Item No.	∅	☐
T40025	0.25 - 0.80mmØ / 30 - 20 AWG	15

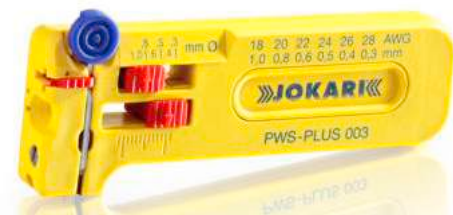

Jokari PWS-PLUS 003

Micro-Precision stripping tool for cable stripping of solid and stranded wires. Working range 0.30-0.40-0.50-0.60-0.80-1.00mmØ. With adjustable length stopper from 1.5 to 22mm. Integrated cutter for wire diameters of up to 0.8mmØ.

TÜV/GS

Item No.	Ø	Box
T40026	0.30 - 1.00mmØ / 28 - 18 AWG	1



Jokari ESD-PLUS 003

Micro-Precision stripping tool for cable stripping of solid and stranded wires. Body made from specialized ESD plastic. Working range 0.30-0.40-0.50-0.60-0.80-1.00mmØ. With adjustable length stopper from 1.5 to 22mm. Integrated cutter for wire diameters of up to 0.8mmØ.

TÜV/GS

Item No.	Ø	Box
T40029	0.30 - 1.00mmØ / 28 - 18 AWG	1



Jokari ESD-PLUS 001

Micro-Precision stripping tool for cable stripping of solid and stranded wires. Body made from specialized ESD plastic. Working range 0.12-0.16-0.20-0.25-0.30-0.40mmØ. With adjustable length stopper from 1.5 to 22mm. Integrated cutter for wire diameters of up to 0.8 mmØ.

TÜV/GS

Item No.	Ø	Box
T40027	0.12 - 0.40mmØ / 36 - 26 AWG	1



Jokari SWS-PLUS 016

Micro-Precision stripping tool for cable stripping of solid and stranded wires. With adjustable length stopper up to 15mm. Integrated cutter for wire diameters of up to 0.8mmØ.

TÜV/GS

Item No.	Ø	Box
T40035	0.16mmØ / 34 AWG	20



Jokari ESD-PLUS 002

Micro-Precision stripping tool for cable stripping of solid and stranded wires. Body made from specialized ESD plastic. Working range 0.25-0.30-0.40-0.50-0.60-0.80mmØ. With adjustable length stopper from 1.5 to 22mm. Integrated cutter for wire diameters of up to 0.8mmØ.

TÜV/GS

Item No.	Ø	Box
T40028	0.25 - 0.80mmØ / 30 - 20 AWG	1



Jokari SWS-PLUS 020

Micro-Precision stripping tool for cable stripping of solid and stranded wires. With adjustable length stopper up to 15mm. Integrated cutter for wire diameters of up to 0.8mmØ. TÜV/GS

Item No.	Ø	
T40045	0.20mmØ / 32 AWG	1



Jokari SWS-PLUS 040

Micro-Precision stripping tool for cable stripping of solid and stranded wires. With adjustable length stopper up to 15mm. Integrated cutter for wire diameters of up to 0.8mmØ. TÜV/GS

Item No.	Ø	
T40075	0.40mmØ / 26 AWG	1



Jokari SWS-PLUS 025

Micro-Precision stripping tool for cable stripping of solid and stranded wires. With adjustable length stopper up to 15mm. Integrated cutter for wire diameters of up to 0.8mmØ. TÜV/GS

Item No.	Ø	
T40055	0.25mmØ / 30 AWG	1



Jokari SWS-PLUS 050

Micro-Precision stripping tool for cable stripping of solid and stranded wires. With adjustable length stopper up to 15mm. Integrated cutter for wire diameters of up to 0.8mmØ. TÜV/GS

Item No.	Ø	
T40085	0.50mmØ / 24 AWG	1



Jokari SWS-PLUS 030

Micro-Precision stripping tool for cable stripping of solid and stranded wires. With adjustable length stopper up to 15mm. Integrated cutter for wire diameters of up to 0.8mmØ. TÜV/GS

Item No.	Ø	
T40065	0.30mmØ / 28 AWG	1



Jokari SWS-PLUS 060

Micro-Precision stripping tool for cable stripping of solid and stranded wires. With adjustable length stopper up to 15mm. Integrated cutter for wire diameters of up to 0.8mmØ. TÜV/GS

Item No.	Ø	
T40095	0.60mmØ / 22 AWG	20



Jokari SWS-PLUS 080

Micro-Precision stripping tool for cable stripping of solid and stranded wires. With adjustable length stopper up to 15mm. Integrated cutter for wire diameters of up to 0.8mmØ.

TÜV/GS

Item No.	Ø	Icon
T40105	0.80mmØ / 20 AWG	1



Jokari SWS-PLUS 100

Micro-Precision stripping tool for cable stripping of solid and stranded wires. With adjustable length stopper up to 15mm. Integrated cutter for wire diameters of up to 0.8mmØ.

TÜV/GS

Item No.	Ø	Icon
T40115	1.00mmØ / 18 AWG	1





Shearing	230
Pruning	232
Felling & Lopping	233
Replacement Parts	235
Cultivating	235
Hoof Cutters	236
Knives	237
Scissors	237
Milling Cutters	240
Kitchen Accessories	240
Cabinet Hinges	240
Snap Hooks	241

Shearing

The original wavy edge shears. Beloved by professionals, a seemingly abuse resistant hedge shear designed for years of hard work.

Hot drop forged and hard chrome armoured waved edge blades.

Precisely hollow ground, self sharpening blades.

Oversize, shock absorbing to prevent jarring.

Barbed tangs and heavy duty, steel ferrules.

Lacquered, hardwood handles.

Fully adjustable blade tension.

Cutting notch.



Shearing







Legend Golden Hedge Shears

Item No.				
G5029	560mm/22"	230mm/9"	1.3kg	1



Legend Silver Hedge Shears

Hot drop forged and hard chrome armoured straight edge blades. Precisely hollow ground, self sharpening blades. Lacquered, hardwood handles. Fully adjustable blade tension. Cutting notch.

Item No.				
G5022A 6	400mm/15.7"		584g	1
G5022A 8	480mm/19"	200mm/8"	800g	1



Maxima Light Weight Hedge Shears

Lightweight design for fatigue free use. Non-stick coated and chrome plated blades for low friction use and resistance to rust. Precision ground, hardened carbon steel blades. Hardwood handles with soft, non-slip grips. Fully adjustable blade tension. Shock absorbing buffers to reduce jarring.

Item No.				
G5010	520mm/20 1/2"	180mm/7"	844g	6



Maxima Long Reach Hedge Shears

Non-stick coated and chrome plated blades for friction free use and resistance to rust. Precision ground, hardened carbon steel blades. Hardwood handles with soft, non-slip grips. Fully adjustable blade tension. Shock absorbing buffers to reduce jarring.

Item No.				
G5011	600mm/24"	200mm/8"	994g	6



Heavy Duty Lawn Edging Shears

Steel ferrules are pinned through the handles. Hot drop forged and hard chrome armoured blades. Precisely hollow ground, self sharpening blades. Lacquered, hardwood handles. Fully adjustable blade tension.

Item No.				
G5051	950mm/37"	209mm/8 1/4"	2.4kg	1



Legend Multi-Purpose Shears

Lightweight and ideal for many uses. Hollow contour, non-stick coated, self sharpening blades. Adjustable blade tension.

Item No.				
G5640	290mm/11 1/2"	105mm/4 1/8"	271g	3



Adjustable Lawn Edging Shears

Hardened and tempered steel blades. Self sharpening. Professional quality, lightweight construction. Telescopic arms, adjustable from 64cm to 105cm.

Item No.	
G5057	1



Maxima Grass Shears

Blades rotate 180 degrees to cut awkward areas. Lightweight and clean cutting. Non-stick coated and chrome plated blades for low friction use and resistance to rust. Secure and precise safety catch for left or right hand use. Blades can cut either vertically or horizontally.

Item No.				
G5637	355mm/14"	115mm/4 1/2"	357g	3



Maxima Lawn Edging Shears

Lightweight shears give a professional finish to the lawn edges. Non-stick coated and chrome plated blades for low friction use and resistance to rust. Tubular steel handles with soft, non-slip grips. Fully adjustable blade tension.

Item No.				
G5015	940mm/37"	175mm/7"	1.5kg	6

Pruning



Legend Heavy Duty Bypass Pruners

Strong, heavy duty pruner complete with its own holster. Non-stick coated blades. Shock absorbing buffer. Adjustable blade tension. Double sided safety lock.

Item No.				
G5610	215mm/8 1/2"	20mm/ 3/4"	300g	3



Maxima Ratchet Pruners

Easy ratchet action. Light, bright and right for all gardeners. Non-stick coated blade for low friction use and resistance to rust. Safety catch.

Item No.				
G5674	185mm/7 1/4"	16mm/ 5/8"	100g	6



Legend Bypass Pruners

Extra thin sharp blade producing a fine cutting action. Non-stick coated blade. Shock absorbing buffer. Fine adjustment blade tension. Safety lock.

Item No.					
G5631	215mm/8 1/2"	20mm/ 3/4"	300g		3
Z5631 2				Blade	1
Z5631 3				Nut/ bolt set	1
Z5631 4				Screw	1



Maxima Anvil Pruners

For pruning older wood. Anvil grips the branch for easier cutting. Non-stick coated and chrome plated blades for low friction use and resistance to rust. Fully adjustable blade tension. Thumb-control safety catch. Two component handles.

Item No.				
G5636	190mm/7 1/2"	16mm/ 5/8"	179g	3



Legend Power Pruners

Lightweight and versatile, equally at home cutting delicate flowers or slicing through the toughest branches. The composite body and moulded grips ensure a comfortable days pruning for both professional and keen gardeners. Full instructions for use on reverse of packaging. Non-stick coated blades. Safety lock.

Item No.					
G5675	195mm/7 3/4"	20mm/ 3/4"	315g		3
Z5675 1				Blade	1



Maxima Bypass Pruners

Ideal for delicate pruning work. Lightweight, pocket sized pruner for shrubs, heather etc. Non-stick coated and chrome plated blades for low friction use and resistance to rust. Fully adjustable blade tension. Thumb-control safety catch. Two component handles.

Item No.				
G5635	190mm/7 1/2"	16mm/ 5/8"	175g	3



Maxima Pruning Snips

Ideal for delicate pruning work. Lightweight, easy to use snips for dead heading, vine pruning and other precise tasks. Non-stick coated and chrome plated blades for low friction use and resistance to rust. Fully adjustable blade tension. Two component handles.

Item No.				
G5634	200mm/8"	10mm/ 3/8"	175g	3
Z5634 1				1



Long Pruning Saw

Precision, taper ground, razor sharp teeth cut on both push and pull strokes without clogging. Comfortable, cushioned handle. Robust holster with belt loop.

Item No.			
G0923	460mm/18 1/2"	446g	3



Locking Pruning Knife

Pruning knife with brass riveted plastic scales and locking function. Fine polished blade with flat back.

Item No.			
G9068L	110mm/4 1/4"	70g	3



Folding Pruning Saws

Precision, taper ground, razor sharp teeth cut on both push and pull strokes without clogging. Comfortable, cushioned handle. Secure safety catch.

Item No.			
G0922	400mm/15 3/4"	200g	3
G0920	Spare blade		1



Pruning Knife

Pruning knife with brass riveted plastic scales. Fine polished blade with flat back.

Item No.			
G9066	95mm/3 3/4"	55g	3

Felling & Lopping



Legend Heavy Duty Bypass Loppers

Fully forged, hardened and tempered special steel blades. Barbed tangs. Lacquered hardwood handles.

Item No.				
G5043	750mm/29 1/2"	45mm/1 1/2"	1.8kg	1
Z5043 1				1



Legend Bypass Loppers

Bypass loppers for green/soft wood. Fully forged, hardened and tempered special steel blades. Barbed tangs and deep ferrules. Wood and rubber buffers to prevent jarring. Lacquered hardwood handles.

Item No.				
G5028	660mm/26"	30mm/1 1/4"	1.2kg	1



Maxima Heavy Duty Bypass Loppers

Heavy duty loppers ideal for small branches and older, tougher wood. Non-stick coated and chrome plated blades for low friction use and resistance to rust. Precision ground, hardened carbon steel blades. Fully adjustable blade tension. Shock absorbing buffer to reduce jarring.

Item No.				
G5013	730mm/28 3/4"	30mm/1 1/2"	1.2kg	6



Legend Anvil Loppers

Anvil cut with cantilever action increases power and reduces effort by 'drawing' the cut. Fully forged, hardened and tempered special steel blades. Non-stick coated blade. Barbed tangs. Lacquered hardwood handles.

Item No.					
G5042	720mm/28"	50mm/2"	1.6kg		1
Z5041 1				Anvil	1
Z5041 2				Blade	1



Maxima Lightweight Bypass Loppers

Compact size allows easy, fatigue free, two handed cutting of small branches. Precision ground, hardened carbon steel blades. Tubular steel handles with soft, non-slip grips. Fully adjustable blade tension. Shock absorbing buffer to reduce jarring.

Item No.				
G5012	480mm/19"	25mm/1"	881g	6



Maxima Telescopic Loppers

Ideal for reaching the highest branches simply and comfortably. Gripping anvil holds stems firmly while the power lever cutting action provides clean, easy cuts. Non-stick coated and chrome plated blades for low friction use and resistance to rust. Precision ground, hardened carbon steel blades. Extendable tubular steel handles with soft, non-slip grips. Fully adjustable blade tension to reduce jarring.

Item No.					
G5014	660 to 990mm/26" to 39"	35mm/1 3/8"	1.8kg		6
Z5014 2				Anvil	1



Steel Hatchets

Chrome tubular steel shaft. Fine polished, drop forged steel head. Comfortable sure-grip rubber handle. Button down leather sheath with belt loop.

Item No.			
G5162	330mm/13"	1.8lb	2



Hatchets

Traditional style hatchet with waxed ash handle and plastic wedge. Hot drop forged steel head, lacquered with polished edge.

Item No.			
G5155 24	360mm/14"	1 ½lb	1
G5155 32	400mm/16"	2lb	1



Felling Axes

Traditional style hatchet with waxed hickory handle and plastic wedge. Hot drop forged steel head, lacquered with polished edge.

Item No.			
G5156 4	800mm/32"	4lb	1
G5156 5	890mm/36"	5lb	1

Replacement Parts



Spare parts for Shearers, Pruners & Loppers

Spare parts to help keep your gardening tools at their best for a lifetime.

Item No.		
G5200	Bolt/nut/washer set for 5200 and 5047 6" and 8", 5056	1
G5201	Spring washer for 5022 and 5047 6" and 8", 5056	1
G5203	Nut/washer set for 5022 and 5047 6" and 8", 5056	1
G5210	Bolt/nut/washer set for 5022 and 5047 9", 5029, 5054	1
G5211	Spring washer for 5022 and 5047 9", 5029, 5054	1
G5213	Rubber buffer for 5028, 5029	1
G5214	Wood buffer for 5028, 5029	1
G5215	Metal cup for 5028, 5029	1
G5217	Nut/washer set for 5022 and 5047 9", 5029, 5054	1
Z5031 1	Spare Blade/Bolt 5031 Blade Set	1
Z5032 0	Spare Blade for 5031	1
Z5652 65	Volute Spring 65mm for G5631	1
Z5652 7	Volute Spring 80mm	1

Cultivating



Digging Spade

Stainless steel blade. Strong plastic shaft with steel core for durability.

Item No.			
G5142	1040mm/41"	2.2kg	1



Digging Fork

Stainless steel fork. Strong plastic shaft with steel core for durability.

Item No.			
G5143	1040mm/41"	2.2kg	1



Border Spade

Stainless steel blade. Strong plastic shaft with steel core for durability.

Item No.			
G5140	1000mm/39 ½"	1.7kg	1



Border Fork

Stainless steel fork. Strong plastic shaft with steel core for durability.

Item No.			
G5141	1000mm/39 1/2"	1.7kg	1



Lawn Edger

Stainless steel blade. Strong plastic shaft with steel core for durability.

Item No.			
G5144	1040mm/41"	1kg	1



Maxima Garden Trowel

Strong, pointed blade for easy digging. Chrome-plated blade. Hardwood handle with soft, non-slip grip.

Item No.			
G5730	300mm/12"	208g	10



Maxima Rockery Trowel

Strong, narrow pointed blade for use in small borders. Chrome-plated blade. Hardwood handle with soft, non-slip grip.

Item No.			
G5731	300mm/12"	180g	10



Maxima Hand Fork

Traditional style three pronged fork, ideal multi purpose cultivator. Chrome-plated blade. Hardwood handle with soft, non-slip grip.

Item No.			
G5732	270mm/10 1/2"	186g	10



Mist Spray

Efficient hand held spray for house, greenhouse or garden. Adjustable from very fine mist to jet.

Item No.		
G6276 1	100g	6

Hoof Cutters



Hoof Cutter

Manufactured from forged steel with polished blades and chequered handles. Stop pin.

Item No.			
T5720	240mm/9 1/2"	394g	6



Hoof Cutter - Serrated

Manufactured from forged steel with polished blades and chequered handles. Stop pin.

Item No.			
T5721	240mm/9 1/2"	394g	6



Locking Knife - Lambsfoot

With lambsfoot blade. Black plastic scales and locking function. Brass riveted.

Item No.			
C9038L	110mm/4 1/4"	70g	3

Knives



Locking Knife - Clip Point

With clip point blade. Black plastic scales. Brass riveted. Lanyard shackle.

Item No.			
C9035L	110mm/4 1/4"	100g	3



Lambsfoot Knives

With lambsfoot blade. Black plastic scales and locking function. Brass riveted.

Item No.				
C9036	95mm/3 3/4"	60g		3
C9036R 1			Containing 20 knives	1
C9036R 2			Containing 50 knives	1



Pocket Knife - Spear Point

With spear point blade. Black plastic scales. Brass riveted. Lanyard shackle.

Item No.			
C9037	95mm/3 3/4"	55g	3

Scissors



Tailors Shears



Designed specifically for cutting fabric on work surface. Fully forged polished blades with black Japanned handles. Bearing bolt adjustment. Side bent.

Item No.			
C809510	260mm/10"	350g	3



Trimmer Scissors - Traditional



Fully forged and nickel plated. Black Japanned handles. Screw adjustment. Sidebent.

Item No.			
C80787	180mm/7"	130g	3
C80788	205mm/8"	170g	3
C80789	230mm/9"	220g	3



Hairdressing Scissors



Fully forged, chrome plated and finely polished. Screw adjustment. With cockade.

Item No.			
C8080	180mm/7"	50g	3



Cut Out Scissors

Fully forged and nickel plated. Screw adjustment.

Item No.			
C80766	155mm/6"	70g	3
C80767	180mm/7"	90g	3



Pocket Scissors

Fully forged and nickel plated. Screw adjustment.

Item No.			
C807245	115mm/4 1/2"	35g	3



Ladies Scissors - Traditional



Fully forged and nickel plated. Screw adjustment. Curved blades.

Item No.			
C80746	155mm/6"	70g	3



Nail Scissors - Straight Blades

Fully forged and nickel plated. Screw adjustment. Straight blades.

Item No.			
C8060	90mm/3 1/2"	15g	3



Nail Scissors - Curved Blades

Fully forged and nickel plated. Screw adjustment. Curved blades.

Item No.			
C8061	90mm/3 1/2"	15g	3



Ladies Scissors - Modern

Stainless steel with moulded plastic handles. Riveted blades.

Item No.			
C8419	160mm/6 1/4"	40g	3



Trimmer Scissors - Modern

Stainless steel with moulded plastic handles. Adjustment screw. Side bent.

Item No.			
C8431	210mm/8 1/4"	100g	3



Embroidery Scissors

Stainless steel with moulded plastic handles. Riveted blades.

Item No.			
C8417	105mm/4"	20g	3



Trimmer Scissors - Serrated

Stainless steel with moulded plastic handles. Serrated cutting edge. Heavy duty adjustment screw. Side bent.

Item No.			
C8432	220mm/8 1/2"	100g	3



Kitchen Scissors

Stainless steel with moulded plastic handles. Serrated cutting edge. With lid opener.

Item No.			
C8435	200mm/8"	90g	6

Milling Cutters



End Mill Cutter

Manufactured with high speed steel blades. For drilling of blind holes for concealed cabinet hinges. For use in electric drills (5000rpm max). Hexagon shank.

Item No.				
T0297 1	26mm	8mm Shank	73g	1
T0297 2	35mm	10mm Shank	98g	20

Kitchen Accessories



Gas Lighter

Triggered, Piezo Electric spark. Stainless steel trim. Wall mounting bracket. Mixed colours.

Item No.			
C6000A	220mm/8 3/4"	100g	6



Waiters Friend Bottle Opener

Unique, patented design with double centrepivot giving a straight pull. Nickel plated with black plastic scales. With corkscrew, bottle opener, can piercer, crown cork lifter and serrated blade for bottle neck foil.

Item No.			
C6096	150mm/6"	70g	6

Cabinet Hinges



Spring Loaded Cabinet Hinges - 175°

Spring loaded cabinet hinges with 175° opening.

Item No.				
T0211S 2	35mm	409g	display packed in pairs	6
T0212S 2	35mm	178g	bulk packed Loose	10



Spring Loaded Cabinet Hinges - 90°

Spring loaded cabinet hinges with 90° opening.

Item No.				
T0208S 1	26mm	139g	display packed in pairs	6
T0208S 2	35mm	190g	display packed in pairs	6
T0209S 1	26mm	56g	bulk packed Loose	20
T0209S 2	35mm	83g	bulk packed Loose	20



Cabinet Hinges - 90°

Cabinet hinges with 90° opening.

Item No.				
T0213S 1	26mm	133g	display packed in pairs	6
T0213S 2	35mm	186g	display packed in pairs	6

Snap Hooks



Heavy Duty Snap Hooks with Swivel Ring



Nickel plated heavy duty hook with swivelring. Snap opening: 9mm.

Item No.			
T7055 4375	110mm/4 3/4"	85g	12



Heavy Duty Snap Hook with Key Ring

Nickel plated hook with stainless steel spring. Key ring. Snap opening: 6mm.

Item No.			
T7056	85mm/3 1/8"	33g	10



Wide Snap Hook with Swivel Eye

Nickel plated with swivel ring.

Item No.			
T7061	85mm/3 1/8"	43g	12



CLIPACORE®

Core Drill Kits	244
Core Drill Bits	244
Drill Sets	245
Core Sets	245
Extension Kits	246
Adaptors	247
Power Tool Spares	247

Core Drill Kits



XPRESSCUT Pro Case Kit

CONTENTS: 5 x Clipacore core adaptors. 5 x Quick release clips. 1 x HEX extension bar with Clipacore drill adaptor. 1 x SDS extension bar with Clipacore drill adaptor. 1 x Clipacore knock out waste removal tool. 1 x A taper 12mm guide pin. 1 x A taper 12mm drill bit. 1 x Drift key. 5 x XPRESSCUT quick release premier Diamond core bits - 42mm / 52mm / 65mm / 117mm / 127mm.

Item No.

QCXPP



1

Core Drill Bits



XPRESSCUT Core Drill Bits

Across the range of sizes sold separately, the core bits have spiralled and slotted barrels, helping remove debris and increasing air flow to the cutting edge. The high quality diamond and UK developed metal bond system provides trouble free cutting for most UK building materials.

Item No.	Ø	↔	📦
QCXP22	22mm	300mm	1
QCXP28	28mm	300mm	1
QCXP42	42mm	150mm	1
QCXP52	52mm	150mm	1
QCXP65	65mm	150mm	1
QCXP78	78mm	150mm	1
QCXP112	112mm	150mm	1
QCXP117	117mm	150mm	1
QCXP127	127mm	150mm	1
QCXP152	152mm	150mm	1



Drill Sets

The Boss Drill

Manufactured from the highest quality using German engineering standards and components. The Boss cuts through bricks, concrete blocks and much more. Consistently delivering high cutting performances with safety constantly in mind. The unique quick release adaptor on the end of the drill allows for fast interchanging of core bits without the need for tools when used with Clipacore core adaptors. The quick release extension bar supplied with every drill ensures most wall depths can be fully penetrated with ease. CONTENTS: Clipacore Quick Release Drill Adaptor designed for interchangeable core bits. Variable Handle Adjustment on Collar. Powerful 2 speed gear box, 1,000 RPM / 2,000 RPM. Electronic Soft Start Temperature Control and Current Cut-Off. Mechanical Safety Clutch. Available in 230v or 110v. Quick release extension bar (supplied).

Item No.

QCTBD110V



1

QCTBD230V

1

Core Sets



Duocut

Our easy to use design enlarges existing holes to a wide variety of diameters for a wide variety of applications, including: Upgrading boiler flues. Upgrading gas pipes. Upgrading waste pipes / soil pipes. Upgrading extractor fans. Upgrading condense pipes. The inner spring-loaded core bit provides easy removal following the wall's outer core scarring, ensuring perfectly symmetrical holes to one another. The larger outer core is quickly released from the drill / arbor adaptor (not supplied) by simply removing the Clipacore Clip.

Item No.

QCDC



1



Condensemata

Clipacore Condensemata puts you in control when upgrading from overflow pipe to 32mm waste pipe (or larger). The 300mm long core bit supplied, simply inserts into the existing open 22mm - 25mm hole (pipe fully removed). Once the outer core bit has scarred the wall, the inner long core bit serving as a guide can be removed by hand. Our easy to use design ensures consistent symmetrical holes eliminating the risk of core bits skidding off course and damaging the wall. The inner spring loaded core bit removes the need for tools thus improving workflow efficiency every time. The 22mm core bit can also be used on its own (with our smaller quick release core adaptor) to prevent blowing the brick face or render wall, compared to using a 22mm SDS masonry drill bit on hammer action.

Item No.	
QCDCCON	1



Fluemata

Safe to use when working at height. Scars the wall symmetrical to existing flue pipe and avoids skidding off course. Can be used with a variety of commonly used core bits. Spring loaded barrel for fast removal once wall is scarred. Fluemata comes with a 1/2" drill/arbore adaptor, DuoCut adaptor with clip, compression spring, 94mm barrel guide.

Item No.	
QCFM	1

Extension Kits



Chuckaway Extension Kit

Chuckaway removes the common problems associated with chuck headed core drills: Chucks seize up over time. Chucks require a chuck key which may get lost. HEX arbors are at risk of shearing off on the flats in chucks due to vibration and coming loose mid drilling. Chuckaway can also be used with the Chuckaway extension bar to penetrate deeper walls. No chuck or chuck key. Quick and safe. Maintenance free. Quick release clip system. High tensile steel built to last.

Item No.	
QCCADAKIT	1
QCCADAM18	1
QCCADAM18KIT	1



Clipacore Hex Driver Extension

Standard drill chuck extension kit, QCHEX plus extension bar and core adaptor.

Item No.	
QCHEXKIT	1



Clipacore SDS Driver Extension

SDS drill extension kit, QCSDS plus extension bar and core adaptor.

Item No.	
QCSDSKIT	1

Adaptors



Chuckaway Drill Adaptor

Makita core drill adaptor for the Chuckaway system.

Item No.
QCCADA



Clipacore Core Adaptor

Fits onto your existing core bits or extension bars. Accepts A taper drill bits/guide pins. Interacts with all Clipacore drill adaptors and Chuckaway extension bars.

Item No.
QCCA



Drill Adaptor

Fits onto your existing SDS, Hex arbors or extension bars.

Item No.
QCCA



Hex Adaptor

Slots into standard drill chuck.

Item No.
QCHEX



Clipacore SDS Drill Adaptor

Slots into SDS drill chuck.

Item No.
QCSDS



Chuckaway Extension Bar

Extension bar for Clipacore Chuckaway. Compatible for use with the Core Adaptor, SDS Driver, HEX Driver, 1/2" 20 UNF, M18 & 1/2" Drill Adaptor.

Item No.
QCCAEB



Power Tool Spares



A Taper Pilot Drill

Taps into core adaptor, centralises the core bit.

Item No.
QCDRILL12



A Taper Guide Pin

Taps into core adaptor, centralises the core bit.

Item No.
QCPIN12



Knock Out Tool

Knock out tool for easy waste removal.

Item No.
QCKOT



Clipacore Spare Clips

Pack of 5 spare clips.

Item No.
QCGRC







Combination Padlocks	252
Key Safes	256
Locking Bolts	257
Keyed Padlocks	258
Shutter Locks	272
Van Locks	273
Hasps & Staples	273
Security Cables & Chains	275
Security Lock-Off	277
Keys	281
Engraving	282
Lubrication	283

Kasp Service Centre

Our Service Centre provides an array of services from simple key cutting to more complex master keyed systems. Ordering is quick and easy, with an average delivery time of just 2-3 days.

Express key cutting

Our express key cutting service allows additional keys to be cut for all Kasp padlocks.

Padlock cloning

Our Service Centre can custom-build additional padlocks to operate with an existing Kasp key.

Keyed alike suites

A wide range of keyed alike padlocks are held in stock, however, for increased security, we can arrange unique keyed alike suites.

Master keyed systems

Tailor-made master keyed suites can be created to meet individual requirements.

Padlock & key engraving

User's names or identification numbers can be engraved on both padlocks and keys.

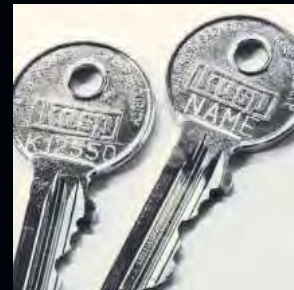

Security rating

The Kasp classification system assists in the selection of the appropriate product. The scale runs from 1 to 15 – the higher the number, the higher the security rating. To further aid selection, ratings have been grouped into 3 general levels of security – low, medium, and high.

High Security



Medium Security



Low Security





LOCKS YOU CAN TRUST



LOW SECURITY

MEDIUM SECURITY

HIGH SECURITY



Impactful POS/ merchandising solutions and informative packaging

To maximise sales potential, the Kasp range is supported by strong POS and merchandising solutions that create stand out. In addition, the colour-coded packaging is designed to be informative and assist your customers to select the correct product for their needs.

www.kaspsecurity.com

Combination Padlocks

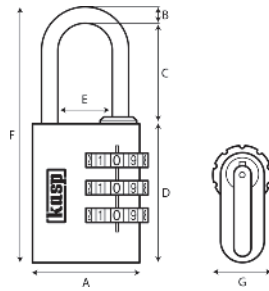

105 Aluminium Combination Padlocks

Ideal for a wide range of applications, the Kasp 105 series offers the convenience of a keyless, resettable combination mechanism, allowing the code to be set to a memorable number of choice. Available in 6 colours; luggage, bags and lockers can be easily identified and personalised.

- Anodised aluminium body - corrosion resistant.
- Steel shackle.
- 3 nickel plated dials.
- Resettable combination - added security.
- 6 colours choices.

Item No.	Shield Icon	Dimensions (mm)							DIALS	Weight (g)	Cubes
		A	B	C	D	E	F	G			
K10520BLAD	2	20	3	21	30	9	54	12	3	24	6
K10520BLUD	2	20	3	21	30	9	54	12	3	24	6
K10520GRED	2	20	3	21	30	9	54	12	3	24	6
K10520PIND	2	20	3	21	30	9	54	12	3	24	6
K10520REDD	2	20	3	21	30	9	54	12	3	24	6
K10520YELD	2	20	3	21	30	9	54	12	3	24	6
K10530BLAD	3	30	5	27	41	12	73	15	3	62	6
K10530BLUD	3	30	5	27	41	12	73	15	3	62	6
K10530GRED	3	30	5	27	41	12	73	15	3	62	6
K10530PIND	3	30	5	27	41	12	73	15	3	62	6
K10530REDD	3	30	5	27	41	12	73	15	3	62	6
K10530YELD	3	30	5	27	41	12	73	15	3	62	6



110 Brass Combination Padlocks

Ideal for a wide range of applications, the solid brass Kasp 110 series offers the convenience of a keyless, resettable combination mechanism. Available in 20, 30, 40mm, and twin pack.

- Resettable combination - added security.
- Solid brass body.
- Steel shackle.
- 20 and 30mm - 3 dials; 40mm - 4 dials.

Item No.		Dimensions (mm)							DIALS		
		A	B	C	D	E	F	G			
K11020D	2	20	3	21	30	9	54	14	3	48	6
K11030D	4	30	5	25	42	12	72	16	3	120	6
K11040D	4	40	6	35	50	19	91	18	4	214	6
K11020D2	2	20	3	21	30	9	54	14	3	96	6



114 Marine Combination Padlocks

Specifically designed for convenience and weather protections; this high quality, three or four dial marine combination padlock is the ideal choice for all low to medium outdoor security uses.

- Mirror chromed solid brass body - superior corrosion resistance.
- Stainless steel shackle - maximum resistance against corrosion.
- Rust-free internal components and shackle seal - extra resistance against corrosion.
- Resettable combination - for added convenience and security.

Item No.		Dimensions (mm)							DIALS		
		A	B	C	D	E	F	G			
K11430D	3	30	5	28	42	12	72	16	3	120	6
K11440D	4	40	6	35	50	19	91	18	4	214	6

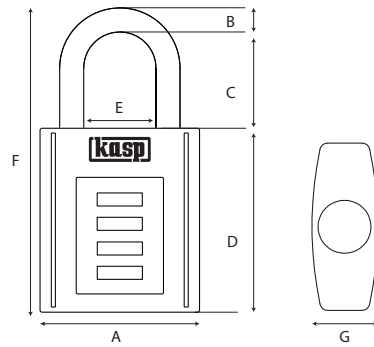

115 Front Combination Padlock

The Kasp 115 front combination padlock is a sturdy, durable and user-friendly padlock, perfect for securing a variety of access points in both residential and commercial applications.

- Code is resettable for extra security - 10,000 possible combinations.
- Key required for resetting (comes with lock).
- Damage resistant, weatherproof cover - ABS-coated, zinc alloy dials and mechanisms for long service life.
- Durable, hardened 7.6mm steel shackle.

Item No.	Shield Icon	Dimensions (mm)							DIALS	Weight (g)	Volume (cm³)
		A	B	C	D	E	F	G			
K11550D	5	52	8	40	61	24	101	24	4	222	60

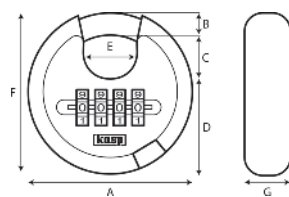

116 Disc Combination Padlock

Convenience and security are provided by this four dial combination padlock. Precision manufactured to the highest standard, ideal for medium security applications including sheds, garages, gates and shutters.

- Resettable combination - for added convenience and security.
- Hardened steel shackle - extra protection against hacksaw and cropping attacks.
- Powder coated body - added resistance against corrosion.
- 4 digit code - for added security.

Item No.	Shield Icon	Dimensions (mm)							DIALS	Weight (g)	Volume (cm³)
		A	B	C	D	E	F	G			
K11670D	8	70	10	17	70	22	70	24	4	240	6



117 Heavy Duty Combination Padlock

Featuring a hardened steel shackle and a tough lock body, the robust Kasp 117 series protects against brutal attack methods whilst offering the convenience of a resettable keyless locking mechanism. The double bolted hi-tech locking mechanism features a special anti-manipulation system to protect the lock from being opened through intelligent manipulation techniques. With its weather resistant lock body and rust free internal components, the Kasp 117 series is ideal for outdoor use.

- Hardened steel shackle - extra protection against hacksaw and cropping attacks.
- Double bolted locking mechanism - extra strength to resist torsion and pull attack.
- Anti-manipulation locking system - resistance against picking attacks.
- 4 dial resettable combination - for added security.
- Rust free internal components - resistance against corrosion.

Item No.	🛡️	Dimensions (mm)							DIALS	🔒 (g)	📦
		A	B	C	D	E	F	G			
K11750D	6	50	8	26	42	25	76	25	4	245	6



119 High Security Combination Padlocks

With its heavy weight hardened steel lock body, super tough molybdenum steel shackle and anti manipulation locking mechanism, Kasp 119 series padlocks are amongst the most secure combination padlocks available today. The hi-tech double bolted locking mechanism features a special anti manipulation system to protect the lock from being opened through intelligent manipulation techniques. The weather resistant electro-plated lock body with rust-free internal components and dual drainage system ensures that the Kasp 119 series is ideal for outdoor use. The Kasp 119 series are true high security combination padlocks, suitable for demanding industrial applications, whilst offering the convenience of a resettable keyless locking mechanism.

- Molybdenum steel shackle - extra protection against hacksaw and cropping attacks.
- Double bolted locking mechanism - extra resistance against torsion and pull attacks.
- Anti-manipulation locking system - protects against attacks.
- 4 dial resettable combination - for convenience and security.
- Rust free internal components & dual drainage system - resistance against corrosion.

Item No.	🛡️	Dimensions (mm)							DIALS	🔒 (g)	📦
		A	B	C	D	E	F	G			
K11960XD	11	60	11	30	750	22	90	35	4	663	6
K11960D	10	60	11	28	53	21.5	90	35	4	593	6

Key Safes

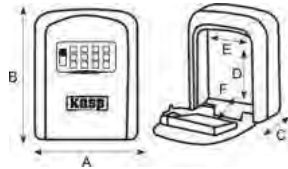

600 Combination Key Safe

Heavy duty, wall mounted spacious storage for keys and entry cards. Ideal, discreet product to safely share access to others - tenants, carers, cleaners, tradespeople and others. Weather resistant body suitable for outdoor or indoor use. Large internal capacity for up to 5 keys. Supplied with full instructions and mounting fixings.

- Tough die cast body - for strength and durability.
- Powder coated body - added resistance against corrosion.
- Black dial weather cover - for discreet product mounting.
- Resettable combination - added convenience and security.
- 4 digit code - for added security.
- Mounting Kit included.

Item No.	Dimensions (mm)						DIALS	📖 (g)	📦
	A	B	C	D	E	F			
K60090D	90	120	40	93	65	28	4	400	1

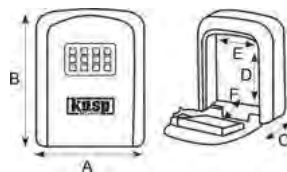

601 Combination Key Safe

A compact key safe perfect for a single key or small set. Simple easy to use with large dial and spring opening. Ideal discreet safe to allow access to multiple users, particularly indoors in an office or factory environment. Easy to mount with fixing kit supplied.

- A compact, easy to open key safe for industrial use or interior, blocks of flats, etc.
- Tough die cast body - for strength and durability.
- Powder coated body - added resistance against corrosion.
- Easy open mechanism - for simple fast access.
- Resettable combination - added convenience and security.
- 4 digit code - for added security.
- Mounting Kit included.

Item No.	Dimensions (mm)						DIALS	📖 (g)	📦
	A	B	C	D	E	F			
K60175D	75	94	37	73	56	24	4	295	1



Locking Bolts



620 Combination Locking Bolt

Convenience and security are combined in this easy to use combination locking bolt. With die cast weatherproof body, horizontal and vertical fitting, 10mm bolt and anti-tamper screws, it's the perfect solution for gates, sheds and lockers.

- Re-settable combination - added convenience and security.
- Weatherproof die cast body - superior corrosion resistance.
- Easy to use 4 dial combination with 10,000 possible combinations.
- 10mm hardened steel security bolt.
- Tamperproof black, stainless steel clutch head screws included.

Item No.	🛡️	Dimensions (mm)		📦
				
K62004D	6	120		5

Keyed Padlocks

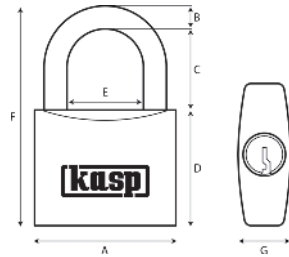

120 Brass Padlocks

Kasp 120 series is a range of general purpose solid brass padlocks featuring a hardened steel shackle. The general purpose 120 series offers a range of affordable padlocks without compromising quality. Available in a variety of sizes and shackle options, the 120 series offers a padlock to suit most domestic security needs.

- Hardened Steel (30mm and above) - extra protection against hacksaw and cropping attacks.
- Double bolted locking mechanism (30mm and above) - extra strength to resist torsion and pull attack.
- Solid brass body - added resistance to corrosion.
- Long shackle - provides greater shackle clearance for versatility.
- 2 keys per padlock.

Item No.	Shield	Dimensions (mm)							PINS	Key 1	Key 2	Weight (g)	Box
		A	B	C	D	E	F	G					
K12020	2	20	3	13	19.5	10	36	10	3	K12020KB	K120KC	31	12
K12020D	2	20	3	13	19.5	10	36	10	3	K12020KB	K120KC	31	6
K12025	2	25	4	15	26	12	45	10	3	K12025KB	K120KC	46	12
K12025D	2	25	4	15	26	12	45	10	3	K12025KB	K120KC	46	6
K12030	3	30	5	18	30	16	53	13	4	K12030KB	K120KC	98	12
K12030D	3	30	5	18	30	15	53	13	4	K12030KB	K120KC	98	6
K12040	3	40	6	22	34	22	63	15	5	K12040KB	K120KC	160	12
K12040D	3	40	6	22	34	22	63	15	5	K12040KB	K120KC	160	6
K12050	6	50	8	30	40	26	78	17	5	K12050KB	K120KC	271	6
K12050D	6	50	8	30	40	26	78	17	5	K12050KB	K120KC	271	6
K12060	8	60	9.5	36	45	32	90	19	5	K12050KB	K120KC	415	6
K12060D	8	60	9.5	36	45	32	90	19	5	K12050KB	K120KC	415	6
Kasp	2	25	4	15	26	12	45	10	3	K12025KB	K120KC	46	12
K12030A1	3	30	5	18	30	15	53	13	4	K12030KB	K120KC	98	12
K12040A1	3	40	6	22	34	22	63	15	5	K12040KB	K120KC	160	12
K12050A1	6	50	8	30	40	26	78	17	5	K12050KB	K120KC	271	6
K12060A2	8	60	9.5	36	45	32	90	19	5	K12050KB	K120KC	830	6
K12020D2	2	20	3	13	19.5	10	36	10	3	K12020KB	K120KC	62	12
K12025D2	2	25	4	15	26	12	45	10	3	K12025KB	K120KC	92	6
K12030D2	3	30	5	18	30	15	53	13	4	K12030KB	K120KC	98	6
K12040D2	3	40	6	22	34	22	63	15	5	K12040KB	K120KC	320	6
K12050D2	6	50	8	30	40	26	78	17	5	K12050KB	K120KC	542	6
K12040D4	3	40	6	22	34	22	63	15	5	K12040KB	K120KC	640	6
K12040L40D	4	40	6	40	34	22	80	15	5	K12040KB	K120KC	164	6
K12040L55D	4	40	6	55	34	22	95	15	5	K12040KB	K120KC	175	6
K12040L63D	4	40	6	63	34	22	103	15	5	K12040KB	K120KC	177	6
K12050L80D	6	50	8	80	40	26	128	17	5	K12050KB	K120KC	315	6
K12040L55A1	4	40	6	55	34	22	95	15	5	K12040KB	K120KC	175	6
K12030L70BD	2	30	5	70	29	15.5	104	13	4	K12030KB	K120KC	196	6
K12050SD	6	50	8	30	40	26	78	17	5	K12050KB	K120KC	271	6

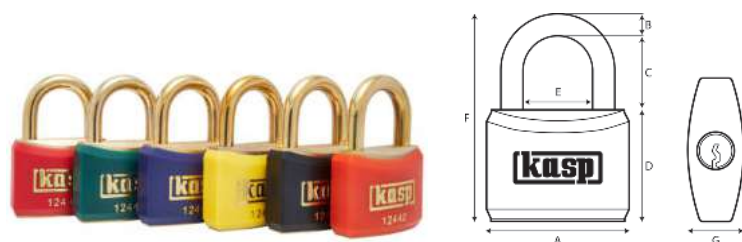

124 Coloured Brass Padlocks

Kasp 124 series padlocks, with lock body and shackle constructed from solid brass, offer corrosion resistance and anti-spark properties. The coloured vinyl jacket not only protects precious paintwork from accidental damage, but also makes the Kasp 124 series the ideal padlock for electrical lock-off applications when combined with the Kasp 200 series lock-off hasp. Available in 6 colours, black, blue, green, orange, red and yellow.

- Brass shackle - anti-spark and added resistance to corrosion.
- Double bolted locking mechanism - extra strength to resist torsion and pull attack.
- Solid brass body - added resistance to corrosion.
- Anti-pick mushroom pins - extra protection against picking.
- Paracentric keyway - extra protection against manipulation.
- Plastic coated body - maximum resistance against corrosion.
- 2 keys per padlock.

Item No.	🛡️	Dimensions (mm)							PINS	🔑	🔑	🔒 (g)	📦
		A	B	C	D	E	F	G					
K12440BLAD	4	40	6.4	21	33	20	60	17	4	K12440KB	K124KC	131	6
K12440BLUD	4	40	6.4	21	33	20	60	17	4	K12440KB	K124KC	131	6
K12440GRED	4	40	6.4	21	33	20	60	17	4	K12440KB	K124KC	131	6
K12440ORAD	4	40	6.4	21	33	20	60	17	4	K12440KB	K124KC	131	6
K12440REDD	4	40	6.4	21	33	20	60	17	4	K12440KB	K124KC	131	6
K12440YELD	4	40	6.4	21	33	20	60	17	4	K12440KB	K124KC	131	6
K12440BLAA1	4	40	6.4	21	33	20	60	17	4	K12440KB	K124KC	131	12
K12440BLUA1	4	40	6.4	21	33	20	60	17	4	K12440KB	K124KC	131	12
K12440GREA1	4	40	6.4	21	33	20	60	17	4	K12440KB	K124KC	131	12
K12440ORAA1	4	40	6.4	21	33	20	60	17	4	K12440KB	K124KC	131	12
K12440REDA1	4	40	6.4	21	33	20	60	17	4	K12440KB	K124KC	131	12
K12440YELA1	4	40	6.4	21	33	20	60	17	4	K12440KB	K124KC	131	12

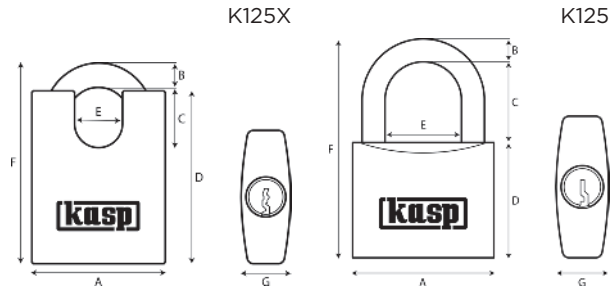





125 Premium Brass Padlocks

Top quality in design and manufacture with precision mechanisms, Kasp 125 series padlocks feature a solid brass body, paracentric keyway and anti-pick cylinder. This versatile, best selling range is available in a wide range of shackle sizes, keying and pack options. The Kasp 125 series is also available as a service padlock, allowing padlocks to be manufactured to specific keying requirements.

- Hardened Steel (20mm and above) - extra protection against hacksaw and cropping attacks.
- 15mm padlock with brass shackle.
- Double bolted locking mechanism (30mm and above) - extra strength to resist torsion and pull attack.
- Solid brass body - added resistance to corrosion.
- Anti-pick mushroom pins (30mm and above) - extra protection against picking.
- Paracentric keyway - extra protection against manipulation.
- 2 keys per padlock.

Item No.	🛡️	Dimensions (mm)							PINS	🗝️	🗝️	📖 (g)	📦
		A	B	C	D	E	F	G					
K12515D	1	15	2.8	12	17	8.5	30	10	3	K12515KB	K125KC	24	12
K12520	2	20	3.5	12	20	10	36	10	3	K12520KB	K125KC	35	12
K12520D	2	20	3.5	12	20	10	36	10	3	K12520KB	K125KC	35	6
K12525	3	25	4	13	25	14	42	12	4	K12525KB	K125KC	58	12
K12525D	3	25	4	13	25	14	42	12	4	K12525KB	K125KC	58	6
K12530	4	30	4.8	17	27	16	50	13	4	K12530KB	K125KC	89	12
K12530D	4	30	4.8	17	27	16	50	13	4	K12530KB	K125KC	89	6
K12535D	4	35	5.5	19	29	16	55	13	4	K12530KB	K125KC	116	6
K12540	5	40	6.4	22	35	22	63	15	5	K12540KB	K125KC	155	12
K12540D	5	40	6.4	22	35	22	63	15	5	K12540KB	K125KC	155	6
K12545D	6	45	7.1	25	36	25	68	15	5	K12540KB	K125KC	194	6
K12550	7	50	8	29	40	28	77	17	5	K12550KB	K125KC	277	6
K12550D	7	50	8	29	40	28	77	17	5	K12550KB	K125KC	277	6
K12560	10	60	9.5	34	46	33	90	19	5	K12550KB	K125KC	422	6
K12560D	10	60	9.5	34	46	33	90	19	5	K12550KB	K125KC	422	6
K12520D2	2	20	3.5	12	20	10	36	10	3	K12520KB	K125KC	70	6
K12525D2	3	25	4	13	25	14	42	12	4	K12525KB	K125KC	116	6
K12530D2	4	30	4.8	17	27	16	50	13	4	K12530KB	K125KC	178	6
K12540D2	5	40	6.4	22	35	22	63	15	5	K12540KB	K125KC	310	6
K12550D2	7	50	8	29	40	28	77	17	5	K12550KB	K125KC	277	6
K12520D4	2	20	3.5	12	20	10	36	10	3	K12520KB	K125KC	140	6
K12540D4	5	40	6.4	22	35	22	63	15	5	K12540KB	K125KC	620	6
K12540L40	5	40	6.4	40	33	22	80	15	5	K12540KB	K125KC	164	6
K12540L40D	5	40	6.4	40	33	22	80	15	5	K12540KB	K125KC	164	6
K12540L63	5	40	6.4	63	33	22	103	15	5	K12540KB	K125KC	175	6
K12540L63D	5	40	6.4	63	33	22	103	15	5	K12540KB	K125KC	175	6
K12550L80D	7	50	8	80	40	28	128	17	5	K12550KB	K125KC	315	6
K12540L40A1	5	40	6.4	40	33	22	80	15	5	K12540KB	K125KC	164	12
K12540L40A5	5	40	6.4	40	33	22	80	15	5	K12540KB	K125KC	164	12
K12540L63A1	5	40	6.4	63	33	22	103	15	5	K12540KB	K125KC	175	12

Item No.		Dimensions (mm)							PINS			 (g)	
		A	B	C	D	E	F	G					
K12540L63A5	5	40	6.4	63	33	22	103	15	5	K12540KB	K125KC	175	12
K12550L80A1	7	50	8	80	40	28	128	17	5	K12550KB	K125KC	315	6
K12550L80A5	7	50	8	80	40	28	128	17	5	K12550KB	K125KC	315	6
K12530L70BD	3	30	4.8	70	27	16	102	13	4	K12530KB	K125KC	102	6
K12540L63BD	4	40	6.4	63	33	22	103	15	5	K12540KB	K125KC	175	6
K12515A1	1	15	2.8	12	17	8.5	30	10	3	K12515KB	K125KC	24	12
K12515A2	1	15	2.8	12	17	8.5	30	10	3	K12515KB	K125KC	24	12
K12520A1	2	20	3.5	12	20	10	36	10	3	K12520KB	K125KC	35	12
K12520A2	2	20	3.5	12	20	10	36	10	3	K12520KB	K125KC	35	12
K12520A3	2	20	3.5	12	20	10	36	10	3	K12520KB	K125KC	35	12
K12520A4	2	20	3.5	12	20	10	36	10	3	K12520KB	K125KC	35	12
K12525A1	3	25	4	13	25	14	42	12	4	K12525KB	K125KC	58	12
K12525A2	3	25	4	13	25	14	42	12	4	K12525KB	K125KC	58	12
K12525A3	3	25	4	13	25	14	42	12	4	K12525KB	K125KC	58	12
K12525A4	3	25	4	13	25	14	42	12	4	K12525KB	K125KC	58	12
K12530A1	4	30	4.8	17	27	16	50	13	4	K12530KB	K125KC	89	12
K12530A2	4	30	4.8	17	27	16	50	13	4	K12530KB	K125KC	89	12
K12530A3	4	30	4.8	17	27	16	50	13	4	K12530KB	K125KC	89	12
K12530A4	4	30	4.8	17	27	16	50	13	4	K12530KB	K125KC	89	12
K12530A5	4	30	4.8	17	27	16	50	13	4	K12530KB	K125KC	89	12
K12530A6	4	30	4.8	17	27	16	50	13	4	K12530KB	K125KC	89	12
K12540A1	5	40	6.4	22	35	22	63	15	5	K12540KB	K125KC	155	12
K12540A2	5	40	6.4	22	35	22	63	15	5	K12540KB	K125KC	155	12
K12540A3	5	40	6.4	22	35	22	63	15	5	K12540KB	K125KC	155	12
K12540A4	5	40	6.4	22	35	22	63	15	5	K12540KB	K125KC	155	12
K12540A5	5	40	6.4	22	35	22	63	15	5	K12540KB	K125KC	155	12
K12540A6	5	40	6.4	22	35	22	63	15	5	K12540KB	K125KC	155	12
K12540A7	5	40	6.4	22	35	22	63	15	5	K12540KB	K125KC	155	12
K12550A1	7	50	8	29	40	28	77	17	5	K12550KB	K125KC	277	6
K12550A2	7	50	8	29	40	28	77	17	5	K12550KB	K125KC	277	6
K12550A3	7	50	8	29	40	28	77	17	5	K12550KB	K125KC	277	6
K12550A4	7	50	8	29	40	28	77	17	5	K12550KB	K125KC	277	6
K12550A5	7	50	8	29	40	28	77	17	5	K12550KB	K125KC	277	6
K12550A6	7	50	8	29	40	28	77	17	5	K12550KB	K125KC	277	6
K12550A7	7	50	8	29	40	28	77	17	5	K12550KB	K125KC	277	6
K12560A1	10	60	9.5	34	46	33	90	19	5	K12550KB	K125KC	422	6
K12560A2	10	60	9.5	34	45	34	90	19	5	K12550KB	K125KC	422	6
K12560A3	10	60	9.5	34	46	33	90	19	5	K12550KB	K125KC	422	6
K12560A4	10	60	9.5	34	46	33	90	19	5	K12550KB	K125KC	422	6
K12540XD	6	40	6.4	18	33	13	63	15	5	K12540KB	K125KC	192	6
K12550XD	8	50	8	20	64	18	74	17	5	K12550KB	K125KC	336	6
K12540KA	5	40	6.4	22	35	22	80	15	5	K12540KB	K125KC	164	1
K12550KA	7	50	8	29	40	28	77	17	5	K12550KB	K125KC	277	1
K12560KA	10	60	9.5	34	46	33	90	19	5	K12550KB	K125KC	422	1
K12540MK	5	40	6.4	22	33	22	63	15	5	K12540KB	K125KC	155	1
K12550MK	7	50	8	29	40	28	77	17	5	K12550KB	K125KC	277	1
K12560MK	10	60	9.5	34	46	33	90	19	5	K12550KB	K125KC	422	1
K12540SA	5	40	6.4	22	33	22	63	15	5	K12540KB	K125KC	155	12
K12550SA	7	50	8	29	40	28	77	17	5	K12550KB	K125KC	276	6
K12560SA	10	60	9.5	34	46	33	90	19	5	K12550KB	K125KC	421	6
K125KACDU												779	



125 Series Component Parts

Item No.		i	 (g)	
K125BG4	40mm	Biting Gauge	25	1
K125BG5	50mm	Biting Gauge	25	1
K125BP41	40mm	Bottom Pin No 1	10	100
K125BP42	40mm	Bottom Pin No 2	10	100
K125BP43	40mm	Bottom Pin No 3	10	100
K125BP44	40mm	Bottom Pin No 4	10	100
K125BP45	40mm	Bottom Pin No 5	10	100
K125BP46	40mm	Bottom Pin No 6	10	100
K125BP51	50, 60mm	Bottom Pin No 1	10	100
K125BP52	50, 60mm	Bottom Pin No 2	10	100
K125BP53	50, 60mm	Bottom Pin No 3	10	100
K125BP54	50, 60mm	Bottom Pin No 4	10	100
K125BP55	50, 60mm	Bottom Pin No 5	10	100
K125BP56	50, 60mm	Bottom Pin No 6	10	100
K125BP57	50, 60mm	Bottom Pin No 7	10	100
K125DP4	40mm	Driver Pin	10	100
K125DP5	50, 60mm	Driver Pin	10	100
K125HP4	40mm	Pin Hole Plug	10	100
K125HP5	50, 60mm	Pin Hole Plug	10	100
K125MP4	40mm	Mushroom Pin	10	100
K125MP5	50, 60mm	Mushroom Pin	10	100
K125MW41	40mm	Master Wafer No 1	10	100
K125MW42	40mm	Master Wafer No 2	10	100
K125MW43	40mm	Master Wafer No 3	10	100
K125MW44	40mm	Master Wafer No 4	10	100
K125MW51	50, 60mm	Master Wafer No 1	10	100
K125MW52	50, 60mm	Master Wafer No 2	10	100
K125MW53	50, 60mm	Master Wafer No 3	10	100
K125MW54	50, 60mm	Master Wafer No 4	10	100
K125MW55	50, 60mm	Master Wafer No 5	10	100
K125PK		Pinning Kit		1
K125PS4	40mm	Pin Spring	10	100
K125PS5	50mm	Pin Spring	10	100
K125PS6	60mm	Pin Spring	10	100

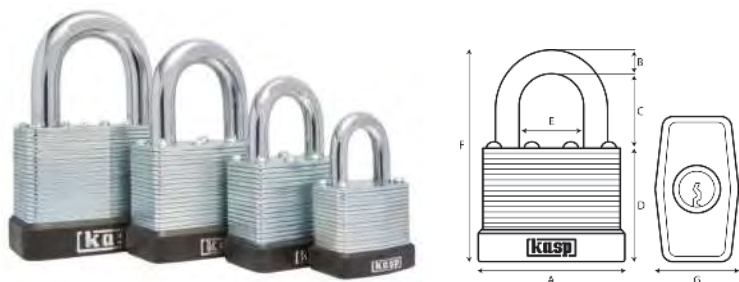

130 Laminated Steel Padlocks

The robust design of this classic style of padlock ensures that it remains as popular as ever. The Kasp 130 series, with a hardened steel shackle, double bolted locking mechanism, paracentric keyway and anti-pick cylinder, combines the latest lock technology with a traditional style.

- Hardened steel - extra protection against hacksaw and cropping attacks.
- Double bolted locking mechanism - extra strength to resist torsion and pull attack.
- Zinc plated steel laminated body - extra strength and resistance to corrosion.
- 8 steel countersunk rivets (4 on 30mm) - extra strength over traditional locks.
- Anti-pick mushroom pins - extra protection against picking.
- Paracentric keyway - extra protection against manipulation.
- 2 keys per padlock.

Item No.	Shield	Dimensions (mm)							PINS	Key 1	Key 2	Weight (g)	Box
		A	B	C	D	E	F	G					
K13030D	4	30	5.5	17	28	14	51	20	4	K13030KB	K130KC	105	6
K13040D	6	40	7.1	22	35	19	65	25	4	K13040KB	K130KC	224	6
K13050	7	50	9.5	29	40	23	79	29	5	K1350KB	K130KC	383	6
K13050D	7	50	9.5	29	40	23	79	29	5	K1350KB	K130KC	383	6
K13060D	10	60	11.1	33	47	28	91	32	5	K1350KB	K130KC	608	6
K13030A1	4	30	5.5	17	28	14	51	20	4	K13030KB	K130KC	105	6
K13040A1	6	40	7.1	22	35	19	65	25	4	K13040KB	K130KC	224	6
K13040A2	6	40	7.1	22	35	19	65	25	4	K13040KB	K130KC	224	6
K13040D2	6	40	7.1	22	35	19	65	25	4	K13040KB	K130KC	448	6
K13050A1	7	50	9.5	29	40	23	79	29	5	K1350KB	K130KC	383	6
K13050A2	7	50	9.5	29	40	23	79	29	5	K1350KB	K130KC	383	6
K13060A1	10	60	11.1	33	47	28	91	32	5	K1350KB	K130KC	608	6
K13050D2	7	50	9.5	29	40	23	79	29	5	K1350KB	K130KC	766	6
K13040L40D	6	40	7.1	22	35	19	65	25	4	K13040KB	K130KC	232	6

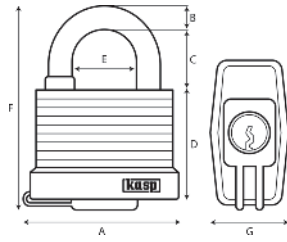

135 Harsh Environment Padlocks

Designed for use in extreme weather conditions, the robust Kasp 135 series features a tough laminated steel body and chrome plated hardened steel shackle, totally encased by an impact resistant, weatherproof vinyl jacket. The durable 5 pin anti-pick cylinder is protected from dirt and moisture by a dust cap.

- Plastic coated hardened steel shackle - extra strength & resistance against corrosion.
- Plastic coated nickel plated steel laminated body - maximum resistance against corrosion.
- Double bolted locking mechanism - extra strength to resist torsion & pull attacks.
- 5 pin cylinder with anti-pick mushroom pins - extra protection against picking.
- Keyhole cover - Protects the mechanism from dirt and moisture.
- Paracentric keyway - extra protection against manipulation.
- 2 keys per padlock.

Item No.	Shield	Dimensions (mm)							PINS	Key 1	Key 2	Weight (g)	Cubes
		A	B	C	D	E	F	G					
K13545D	7	58	12	22	45	21	79	30	5	K13545KB	K135KC	380	6
K13545L63D	7	65	12	63	45	21	120	30	5	K13545KB	K135KC	417	6

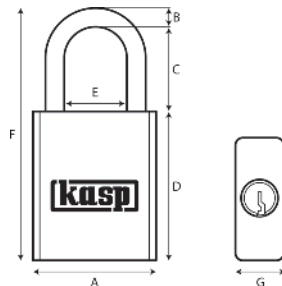

140 Solid Aluminium Padlocks

The Kasp 140 series is constructed from solid aluminium ensuring a high level of weather resistance. In addition, this highly sophisticated lock provides wide ranging protection against a number of forms of attack. It is also an ideal padlock for lock-off applications. Available in 6 colours, black, gold, blue, red, green, silver.

- Anodised aluminium body - superior weather resistance.
- Hardened steel shackle - extra protection against hacksaw and cropping attacks.
- Double ball bearing locking - extra strength to resist torsion and pull attack.
- Anti-pick - extra protection against picking.
- Anti-bump cylinder - further keyway protection.
- 2 keys per padlock.

Item No.	Shield	Dimensions (mm)							PINS	Key 1	Key 2	Weight (g)	Cubes
		A	B	C	D	E	F	G					
K14040BLAD	7	38	6.3	25	45	20	76	19	6	K14040KB	K140KC	147	6
K14040BLUD	7	38	6.3	25	45	20	76	19	6	K14040KB	K140KC	147	6
K14040GOLD	7	38	6.3	25	45	20	76	19	6	K14040KB	K140KC	147	6
K14040GRED	7	38	6.3	25	45	20	76	19	6	K14040KB	K140KC	147	6
K14040REDD	7	38	6.3	25	45	20	76	19	6	K14040KB	K140KC	147	6
K14040SILD	7	38	6.3	25	45	20	76	19	6	K14040KB	K140KC	147	6



145 Marine Padlocks

The 145 Marine padlock has been designed and manufactured to the highest standards to offer a secure padlock with exceptional weather resistance. The mirror chromed solid brass body, rust free internal components, 316 stainless steel shackle and rubber shackle seal combine to provide corrosion resistance in the most extreme environments. Security is paramount, with a double bolted shackle to resist torsion/pull attack and a 5 pin anti-pick cylinder designed to withstand manipulation. Range includes 40 and 50mm in standard and long shackle, both keyed to differ and keyed alike.

- Marine grade 316 Stainless Steel Shackle - extreme weather protection, tested to ISO 9227.
- Mirror chromed brass padlock - extreme weather protection.
- Rubber shackle seal - protects the cylinder from water ingress.
- Rust-free stainless steel and brass internal components.
- Double bolted locking mechanism - strength against torsion and pull attack.
- Anti-pick mushroom pins - protection against picking.
- Paracentric keyway - extra protection against manipulation.
- 2 keys per padlock.

Item No.	Shield Icon	Dimensions (mm)							PINS	Key Icon 1	Key Icon 2	Weight (g)	Cube Icon
		A	B	C	D	E	F	G					
K14540D	5	40	6.35	22	33	22	62	14.5	6	K14540KB	K145KC	158	10
K14550D	7	50	8	29	40	28	77	17	5	K14550KB	K145KC	277	10
K14540A1	5	40	6.35	22	33	22	62	14.5	5	K14540KB	K145KC	158	10
K14540A2	5	40	6.35	22	33	22	62	14.5	5	K14540KB	K145KC	158	10
K14540A3	5	40	6.35	22	33	22	62	14.5	5	K14540KB	K145KC	158	10
K14550A1	7	50	8	29	40	28	77	17	5	K14550KB	K145KC	277	10
K14550A2	7	50	8	29	40	28	77	17	5	K14550KB	K145KC	277	10
K14550A3	7	50	8	29	40	28	77	17	5	K14550KB	K145KC	277	10
K14540L50D	5	40	6.35	50	33	22	90	14.5	5	K14540KB	K145KC	173	10
K14550L63D	7	50	8	63	40	28	116	17	5	K14550KB	K145KC	305	10
K14540L50A1	5	40	6.35	50	33	22	90	14.5	5	K14540KB	K145KC	173	10
K14550L63A1	7	50	8	63	40	28	116	17	5	K14550KB	K145KC	305	10



150 Stainless Steel Padlock

Manufactured from a solid block of marine grade stainless steel, the robust Kasp 150 series is capable of meeting the stringent demands of high security industrial applications whilst offering the reassurance of an entirely corrosion resistant construction. The 5-pin anti-pick cylinder is designed to withstand intelligent picking and manipulation methods, whilst the 9mm stainless steel shackle is secured in the locked position by two ball bearings, universally accepted as one of the most secure locking mechanisms available.

- Stainless steel shackle - maximum protection against corrosion.
- Closed shackle - additional shackle protection to resist shackle attack.
- Double ball bearing locking mechanism - extra strength to resist torsion & pull attacks.
- Anti-pick mushroom pins - extra protection against picking.
- Rust-free internal components & drainage system - extra resistance against corrosion.
- Key retaining.
- Paracentric keyway - extra protection against manipulation.
- 2 keys per padlock.

Item No.	Shield Icon	Dimensions (mm)							PINS	Key Icon 1	Key Icon 2	Weight (g)	Cube Icon
		A	B	C	D	E	F	G					
K15050D	11	50	9	20	59	18	73	20	5	K18060KB	K180KC	372	6

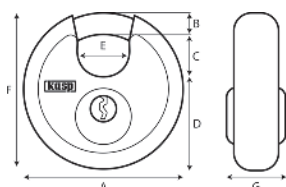

160 Disc Padlocks

With a robust stainless steel body and exceptional design, the Kasp 160 series combines corrosion resistance and high security. In the locked position the distinctive shape protects the shackle from saw and cropping attack whilst the anti-drill (70mm only), anti-pick cylinder provides excellent protection to cylinder attack.

- Hardened Steel Shackle - extra protection against hacksaw & cropping attacks.
- Double bolted locking mechanism - extra strength to resist torsion & pull attacks.
- Stainless steel body - maximum resistance against corrosion.
- Anti-pick mushroom pins - extra protection against picking.
- Paracentric keyway - extra protection against manipulation.
- Key retaining.
- 70mm - anti drill, anti-pick cylinder.
- 2 keys per padlock.

Item No.	🛡️	Dimensions (mm)							PINS	🔑	🔑	🏷️ (g)	📦
		A	B	C	D	E	F	G					
K16060D	9	60	8	13	60	22	60	26	5	K16070KB	K160KC	180	6
K16070D	11	70	10	17	70	22	70	29	5	K16070KB	K160KC	262	6
K16070A1	11	70	10	17	70	22	70	29	5	K16070KB	K160KC	262	6
K16070A2	11	70	10	17	70	22	70	29	5	K16070KB	K160KC	262	6
K16070A3	11	70	10	17	70	22	70	29	5	K16070KB	K160KC	262	6
K16070D2	11	70	10	17	70	22	70	29	5	K16070KB	K160KC	524	6
K16070D260	11	175	10	17	70	22	70	35	5	K16070KB	K160KC	250	6

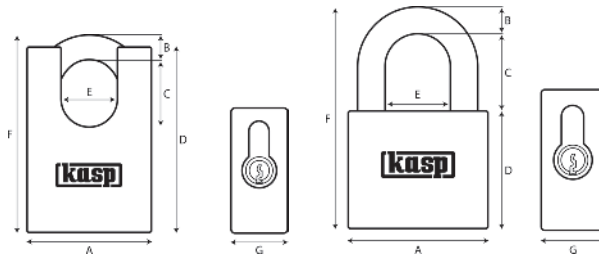

180 Hardened Steel Padlocks



Manufactured from a solid block of hardened steel, the tough and durable Kasp 180 series has been specifically designed to meet the stringent demands of industrial applications, but is equally suited for high security domestic requirements. Featuring a 12mm hardened steel shackle, double ball bearing locking mechanism and a rekeyable 5 pin anti-pick cylinder, the Kasp 180 series offers a high level of protection against brutal and intelligent methods of attack. The fully chrome plated lock body and shackle ensures that the Kasp 180 series is ideal for outdoor use.

- Hardened Steel Shackle - extra protection against hacksaw & cropping attacks.
- Double ball bearing locking mechanism - extra strength to resist torsion & pull attacks.
- Chrome plated hardened steel body - extra strength & resistance against corrosion.
- 5 pin cylinder with anti-pick mushroom pins - extra protection against picking.
- Paracentric keyway - extra protection against manipulation.
- Key retaining.
- 2 keys per padlock.

Item No.	Shield Icon	Dimensions (mm)							PINS	Key Icon 1	Key Icon 2	Weight (g)	Cube Icon
		A	B	C	D	E	F	G					
K18060	11	60	12	36	53	29	101	27	5	K18060KB	K180KC	628	3
K18060D	11	60	12	36	53	29	101	27	5	K18060KB	K180KC	628	3
K18060KA	11	60	12	36	53	29	101	27	5	K18060KB	K180KC	628	1
K18060MK	11	60	12	36	53	29	101	27	5	K18060KB	K180KC	628	1
K18060XD	13	60	12	35	90	28	98	27	5	K18060KB	K180KC	726	3
K18060XKA	13	60	12	35	90	28	98	27	5	K18060KB	K180KC	726	1
K18060XMK	13	60	12	35	90	28	98	27	5	K18060KB	K180KC	726	1



180 Series Component Parts

Item No.	i	 (g)	
K180BG	Bitting Gauge	25	1
K180BP1	Bottom Pin No 1	10	100
K180BP2	Bottom Pin No 2	10	100
K180BP3	Bottom Pin No 3	10	100
K180BP4	Bottom Pin No 4	10	100
K180BP5	Bottom Pin No 5	10	100
K180BP6	Bottom Pin No 6	10	100
K180MW1	Master Wafer No 1	10	100
K180MW2	Master Wafer No 2	10	100
K180MW3	Master Wafer No 3	10	100
K180MW4	Master Wafer No 4	10	100
K180MW5	Master Wafer No 5	10	100
K180PK	Pinning Kit	514	1
K180RC	Retaining Clip	1	1

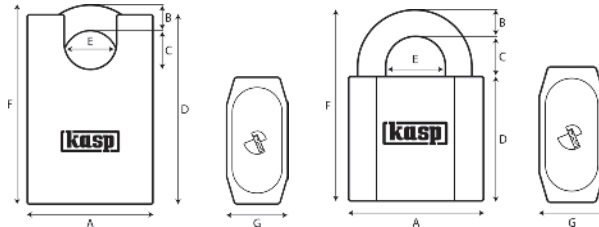

190 High Security Padlocks

Renowned for their extreme strength, Kasp 190 series padlocks have been designed and manufactured in accordance with the stringent internationally recognised Central European Norm specifications. The closed shackle version conforms to BS EN 12320 : Grade



6, the highest grade within the Central European Norm security standard, ensuring it is amongst the most secure padlocks available today. Precision crafted from a solid block of high grade hardened steel, weighing over 1.5kgs (3.3lbs), the Kasp 190 Series is a true heavy weight that will resist the most brutal of attacks. The rekeyable, drill resistant 6-pin cylinder featuring anti-pick pins is designed to resist intelligent picking and manipulation methods, whilst the 14mm hardened boron steel shackle is secured in the locked position by 2 ball bearings, universally accepted as one of the most secure locking mechanisms available.

- Conforms to BS EN 12320: Grade 6 - amongst the most secure padlocks available today.
- Hardened Boron Alloy Steel Shackle - extra protection against hacksaw & cropping attacks.
- Double Ball Bearing Locking Mechanism - maximum strength to resist torsion & pull attacks.
- Pearl Nickel plated hardened steel body - extra strength & resistance against corrosion.
- 6 pin cylinder with anti-pick mushroom pins - extra protection against picking.
- Paracentric keyway - extra protection against manipulation.
- Drill resistant keyway - protects the cylinder against drill attack.
- 2 keys per padlock.
- Key retaining.

Item No.	Shield Icon	Dimensions (mm)							PINS	Key Icon 1	Key Icon 2	Weight (g)	Cube Icon
		A	B	C	D	E	F	G					
K19070D	14	70	14	20	65	30	99	34	6	K19070KB	K190KC	1205	3
K19070KA	14	70	14	20	65	30	99	34	6	K19070KB	K190KC	1205	1
K19070MK	14	70	14	20	65	30	99	34	6	K19070KB	K190KC	1205	1
K19070XD	15	70	14	20	105	27	110	34	6	K19070KB	K190KC	1598	3
K19070XKA	15	70	14	20	105	27	110	34	6	K19070KB	K190KC	1598	1
K19070XMK	15	70	14	20	105	27	110	34	6	K19070KB	K190KC	1598	1



190 Series Component Parts

Item No.	i	 (g)	
K190BG	Bitting Gauge	20	1
K190BP0	Bottom Pin No 0	10	100
K190BP1	Bottom Pin No 1	10	100
K190BP2	Bottom Pin No 2	10	100
K190BP3	Bottom Pin No 3	10	100
K190BP4	Bottom Pin No 4	10	100
K190BP5	Bottom Pin No 5	10	100
K190BP6	Bottom Pin No 6	10	100
K190BP7	Bottom Pin No 7	10	100
K190BP8	Bottom Pin No 8	10	100
K190BP9	Bottom Pin No 9	10	100
K190MW1	Master Wafer No 1	10	100
K190MW2	Master Wafer No 2	10	100
K190MW3	Master Wafer No 3	10	100
K190MW4	Master Wafer No 4	10	100
K190MW5	Master Wafer No 5	10	100
K190MW6	Master Wafer No 6	10	100
K190MW7	Master Wafer No 7	10	100
K190MW8	Master Wafer No 8	10	100

Shutter Locks

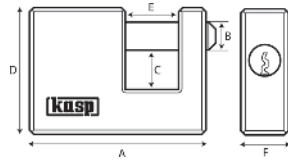

170 Brass Shutter Locks

The Kasp 170 series is ideal where a higher level of security is required. Originally designed for securing commercial shutters and grilles, this solid brass bodied lock offers excellent protection against cropping attack whilst the rotating hardened steel shackle makes hacksaw attack virtually impossible.

- Rotating Hardened Steel Shackle - extra protection against hacksaw & cropping attacks.
- Solid Brass Body - added resistance against corrosion.
- Anti-pick mushroom pins - extra protection against picking.
- Paracentric keyway - extra protection against manipulation.
- 2 keys per padlock.

Item No.	Shield Icon	Dimensions (mm)							PINS	Key 1	Key 2	Weight (g)	Cubes
		A	B	C	D	E	F	G					
K17063D	8	63	10	14	42	18	42	16	5	K13050KB	K130KC	296	6
K17070	9	70	12	13	50	21	50	50	5	K13050KB	K130KC	426	6
K17070D	9	70	12	13	50	21	50	50	5	K13050KB	K130KC	426	6
K17090D	11	90	12	18	60	34	60	20	5	K18060KB	K180KC	702	6

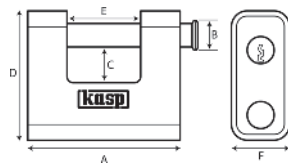

175 Armoured Shutter Locks

With its ingenious design and reassuringly heavyweight construction, the Kasp 175 series offers a high level of resistance to virtually all conventional forms of attack. Its rotating hardened steel shackle makes hacksaw attack virtually impossible, and together with a ball bearing locking mechanism, hardened steel armoured jacket, anti-pick cylinder, and drill resistant keyway, the 175 series is extremely tough under attack.

- Hardened steel shackle - extra protection against hacksaw & cropping attacks.
- Double ball bearing locking mechanism - extra strength to resist torsion & pull attacks.
- Solid brass body encased in a steel jacket - extra strength & resistance against corrosion.
- Anti-pick mushroom pins - extra protection against picking.
- Paracentric keyway - extra protection against manipulation.
- 2 keys per padlock.

Item No.	Shield Icon	Dimensions (mm)							PINS	Key 1	Key 2	Weight (g)	Cubes
		A	B	C	D	E	F	G					
K17580	11	80	12	17	65	37	65	30	5	K18060KB	K180KC	810	6
K17580D	11	80	12	17	65	37	65	30	5	K18060KB	K180KC	810	6
K17580A1	11	80	12	17	65	37	65	30	5	K18060KB	K180KC	810	6

Van Locks

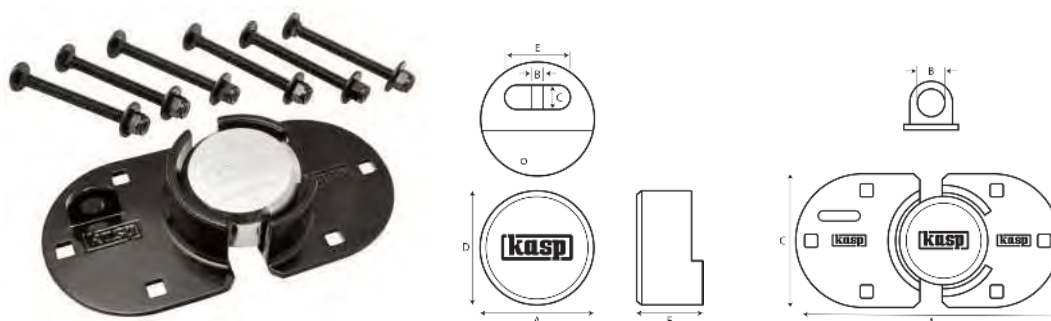

500 Van Lock & Hasps

The design of the Kasp 500 Series Van Lock makes it almost impervious to conventional forms of attack. Specifically designed to meet the stringent demands of industrial vehicle applications, the Kasp 500 Series will resist the most savage of attacks. The high security anti-pick, 6-pin locking mechanism will resist intelligent picking and manipulation methods, whilst the walls of the hasp protect the heavyweight hardened steel lock offering virtually no points of effective attack.

Padlock:

- Chrome plated hardened steel body - extra strength and protection from corrosion.
- Shrouded steel shackle - maximum protection against hacksaw and cropping attacks.
- 6 Pin cylinder - extra protection against picking.
- Corrosion resistant mechanism - reliable in potentially harsh environment.

Hasp:

- Black powder coated heavy duty steel construction - extra strength and protection against corrosion.
- Supplied complete with fixing bolts - security and convenience.
- Integral storage bracket for secure storage of the lock when open.

Item No.	Shield Icon	Dimensions (mm)						PINS	Key Icon 1	Key Icon 2	Weight (g)	Cubes
		A	B	C	D	E	F					
K50073A	10	230	115	15.5						2560	4	
K50073LD	13	72	10	14	72	43	72	6	K50073KB K500KC	947	6	
K50073ACB										10521	1	

Hasps & Staples



210 Traditional Hasp & Staples

A traditional style hasp and staple, the Kasp 210 series offers a basic level of security for general applications.

- Hardened staple - extra protection against attack.
- Chrome plated finish - extra resistance against corrosion.
- Concealed fixings included - added security.

Item No.	Shield Icon	Dimensions (mm)			Weight (g)	Cubes
		A	B	C		
K21075D	2	75	28	9	66	6
K21095D	4	95	39	13	133	6
K210115D	5	115	47	13.4	183	6

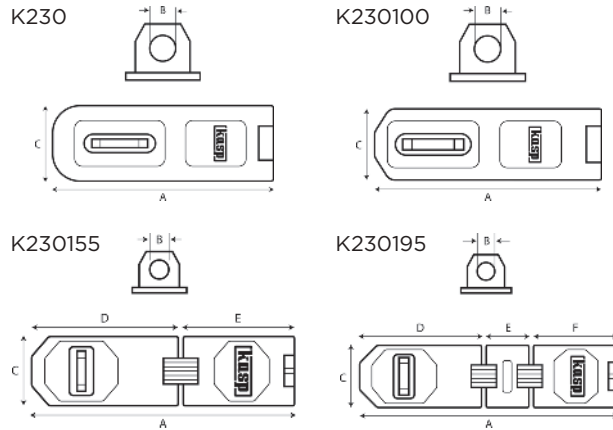

230 Universal Hasp & Staples

Tough and robust in construction, the Kasp 230 series is manufactured from heavy gauge steel with anti corrosion properties. Featuring a hardened steel staple and concealed hinge pin, the Kasp 230 series protects against brutal attack methods.

- Hardened staple - extra protection against attack.
- Zinc plated finish - extra resistance against corrosion.
- Concealed hinge pins - prevents knock through attack.
- Concealed fixings included - added security.

Item No.	Shield Icon	Dimensions (mm)						Weight (g)	Cubes
		A	B	C	D	E	F		
K23060D	2	60	20	6				21	6
K23080D	2	80	23	10				66	6
K230100D	6	100	35	9				159	6
K230155D	8	155	35	12	184	270		307	6
K230195D	10	195	45	12	185	236	370	381	6

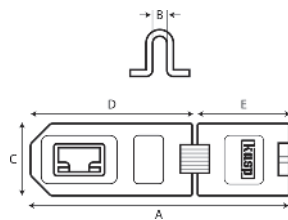

260 Hasp & Staple for Disk Lock

The tough and robust Kasp 260 series was specially designed to compliment the Kasp 160 series disc padlock but also offers additional shackle protection when used with other types of padlocks. The unique hardened steel staple protects the shackle from conventional forms of cutting and cropping attack.

- Specially designed hardened steel staple - designed to completely enclose disc padlock shackles providing extra protection against attack.
- Used with other padlocks for increased security.
- Zinc plated finish - extra resistance against corrosion.
- Concealed hinge pins - prevents knock through attack.
- Concealed fixings included - added security.

Item No.	Shield Icon	Dimensions (mm)					Weight (g)	Cubes
		A	B	C	D	E		
K260120D	9	120	55	30			306	3
K260190	11	190	45	13	1116	268	445	3
K260190D	11	190	45	13	1116	268	445	6

Security Cables & Chains

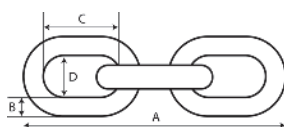

450 Series Security Chains

A quality security chain, the Kasp 450 series features hardened steel square links with extra strong welds offering a high level of resistance to crop, saw and pull attack. Encased in a durable fabric sleeve, reassuringly embroidered with the Kasp logo, the 450 series cuts no corners when it comes to security.

- Woven fabric sleeve - protects paintwork from accidental damage.
- Square section chain - extra resistance against bolt cutter attacks.
- Hardened boron steel links - extra protection against hacksaw & cropping attacks.
- Induction welded links - resists pull and torsion attack.
- Fully galvanised finish - protection against corrosion.

Item No.	🛡️	Dimensions (mm)				LOCK SERIES	📏 (g)	📦
		A	B	C	D			
K4506L85A	5	850	6	40	10		670	3
K4508L110A	9	1100	8	50	13		1421	3
K45010L110A	15	1100	10	50	16		2196	3
K45010L140	15	1400	10	50	16		3234	3
K45010L170A	15	1700	10	50	16		4106	3
K4506130A	5	850	6	40	10	130	896	1
K4508135A	9	1100	8	50	13	135	1798	1
K45010180A	13	1100	10	50	16	180	3140	1



455 Double Loop Security Cable

Strong and flexible security cable for low to medium security situations. Braided steel cable with a weather and abrasion resistant vinyl coating. Double Loop design can be intertwined and locked with a padlock. Ideal for push bikes, gates, outdoor furniture, garage items, site equipment etc.

- Multi-strand flexible steel cable – ease of use.
- Weather resistant protective vinyl coating.
- Double loop for usage flexibility, extra length and cinching.

Item No.	🛡️	Dimensions (mm)		📏 (g)	📦
		A	B		
K4551018D	4	1800	10	313	6
K4551220D	6	2000	12	492	6



470 Combination Chain Lock

A heavy duty 8mm hardened steel chain twinned with a 5 dial combination lock providing security and keyless convenience for medium security situations. Ideal for bikes, gates, garage items and site equipment e.g. tools and lighting.

- Woven fabric sleeve - protects paintwork and cutting attack.
- Hardened square steel links - extra protection from hacksaw and cropping attacks.
- 5 Dial Combination lock - 100,000 combinations - anti-pick resistance.
- Resettable to your own combination.
- Large easy to use dial.

Item No.	Shield Icon	Dimensions (mm)		DIALS	Weight (g)	Cubes
		A	B			
K470810D	9	1000	8	5	1395	6

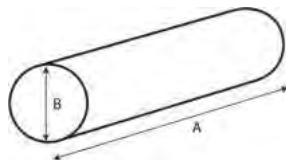

475 Combination Cable Lock

Strong and flexible security cable twinned with an easy to use 4 dial combination lock providing security and convenience for medium security situations. Ideal for push bikes, gates, outdoor furniture, tools and equipment etc.

- Multi-strand flexible steel cable - ease of use.
- Weather resistant protective vinyl coating.
- 4 Dial Combination lock - 10,000 combinations - anti-pick resistance.
- Resettable to your own combination.

Item No.	Shield Icon	Dimensions (mm)		DIALS	Weight (g)	Cubes
		A	B			
K4751215D	6	1500	12	4	375	6

Security Lock-Off

120 Brass Padlock - Lock-Off

Solid brass body - ideal for lock-off purposes.

Item No.	Shield	Dimensions (mm)							PINS	Key	Key	Weight (g)	Cubes
		A	B	C	D	E	F	G					
K12025LO	2	25	4	15	26	12	45	10	3	K12025KB	K120KC	46	6

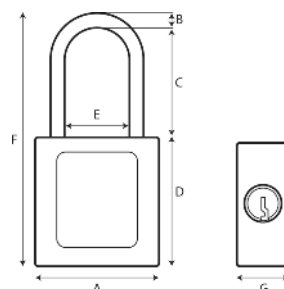

800 Nylon Safety Padlocks

Constructed from Nylon the 800 series is a non-conductive, non-sparking padlock suitable for electrical lock-off applications. For ease of identification, each lock is supplied with 7 different coloured 'Danger' stickers (yellow, white, black, blue, orange, red, green) as well as 'Property of' stickers.

- Nylon body and shackle - non-conductive, non-sparking.
- Key retaining.
- 7 coloured 'DANGER' stickers.
- 1 key per padlock.

Item No.	Dimensions (mm)							PINS	Weight (g)	Cubes
	A	B	C	D	E	F	G			
K80040	40	6.5	38	44	20	88	18	6	62	6
K80040D	40	6.5	38	44	20	88	18	6	62	6
K800CBOX									1137	1

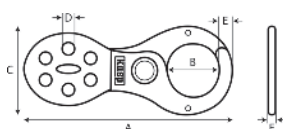

200 Lock-Off Hasps

Health & Safety regulations demand that industrial plant and machinery power units are isolated whilst maintenance work is carried out. Kasp 200 series lock-off hasps combined with Kasp 124 or 800 series padlocks offer an ideal solution, allowing up to 6 workers to lock off an individual energy source.

Item No.	Dimensions (mm)								Weight (g)	Cubes
	A	B	C	D	E	F	G	H		
K20025D	47	7	25	53	25	130	8	11	114	6
K20038D	60	7	28	57	38	140	10	11	100	6

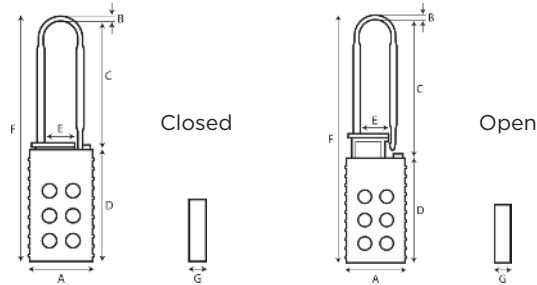

205 Lock-Off Hasps

Non-conductive and non-sparking this nylon Kasp 205 hasp is ideal in electrical situations to lock off access to switchboards whilst maintenance is being carried out. Ideally used with the Kasp 800 series nylon safety padlock.

Item No.	Dimensions (mm)								📖 (g)	📦
	A	B	C	D	E	F	G	H		
K20518	45	7	78	75	18	140	12	8	32	6
K20518D	45	7	78	75	18	140	12	8	32	6



810 Easifit MCB Lock-Off

Universal Mini Circuit Breaker for single to triple switches. Simple and quick installation with no tools. Place over the switch, tighten with finger and thumb, rotate screw toggle and lock-off with padlock as normal.

Item No.	↔	∅	📖 (g)	📦



811 Essential Lockout Kit

A unique MCB lockout kit with all the essential parts needed to lockout one mini circuit breaker. Handy carabiner holds the kit together when not in use and when in use keeps the padlock keys safe.

The kit includes:





- Easifit MCB Lockout.
- Brass Padlock 25mm.
- Danger/ Identity Tag.
- Carabiner to hold the kit together.

Item No.		 (g)	
K81100		100	6



812 MCB Lockout - Pin Out Wide

Simple push button installation, no tools required. Ideal for locking out wider Miniature Circuit breakers. High quality non conductive material. Uses one padlock, maximum shackle diameter 6mm.

Item No.			 (g)	
K81200	42	7	7	6



813 Electrical Lockout Kit

Ideal kit for a broad range of circuit breaker, including breakers over 60 amp. Easy to use and contents held securely in a sturdy pouch.

The kit includes:

- Lockout pouch.
- Red vinyl coloured brass padlock with brass shackle 40mm.
- Brass padlock 25mm.
- Easifit MCB lockout.
- Pin Out Wide lockout.
- Lock off hasp.
- Tagout Marker Pen.
- Danger Tag.

Item No.	 (g)	
K81300	389	1

Keys



Key Blanks

Key blanks for our series of padlocks.

Item No.	SERIES	i		
K10050KB	100	Old English Padlock	50	50
K12020KB	120	Brass Padlock	20	50
K12025KB	120	Brass Padlock	25	50
K12030KB	120	Brass Padlock	30	50
K12040KB	120	Brass Padlock	40	50
K12050KB	120	Brass Padlock	50, 60	50
K12440KB	124	Vinyl Coated Brass Padlock	40	100
K12515KB	125	Premium Brass Padlock	15	100
K12520KB	125	Premium Brass Padlock	20	100
K12525KB	125	Premium Brass Padlock	25	100
K12530KB	125	Premium Brass Padlock	30, 35	100
K12540KB	125	Premium Brass Padlock	40, 45	100
K12550KB	125	Premium Brass Padlock	50, 60	100
K13030KB	130	Laminated Steel Padlock	30	100
K13040KB	130	Laminated Steel Padlock	40	100
K13050KB	130 50 & 60mm/170 70 & 63mm	Laminated Steel/Shutter Lock	50, 60/ 170 70	100
K13545KB	135	Harsh Environment Padlock	45	50
K14040KB	140	Aluminium Padlock	40	100
K14540KB	145	Marine Padlock	40	100
K14550KB	145	Marine Padlock	50	100
K16070KB	160	Disc Padlock	60, 70	50
K18060KB	150/170 90mm/175/180	Stainless Steel/Shutter Lock/Hardened Steel Padlock	50/170 90mm/175/180	100
K19070KB	190	High Security Padlock	70	100
K50073KB	500	Van Lock	73	50



Cut Keys

Keys cut to order by our locksmiths.

Item No.	SERIES	i	
K120KC	120	Brass Padlock	1
K124KC	124	Vinyl Coated Brass Padlock	1
K125KC	125	Premium Brass Padlock	1
K130KC	130	Laminated Steel Padlock	1
K135KC	135	Harsh Environment Padlock	1
K140KC	140	Aluminium Padlock	1
K145KC	145	Marine Padlock	1
K160KC	160	Disc Padlock	1
K180KC	180	Hardened Steel Padlock	1
K190KC	190	High Security Padlock	1
K500KC	500	Van Lock	1

Engraving



Engraving

Padlocks and Keys can be engraved by our Service Centre. Maximum number of digits apply, for example 40mm brass maximum is 16 digits at 2.3mm in height. Please ask for details.

Item No.	
STAMP	1

Lubrication

**Microfibre Graphite Powder**

Microfine, greaseless and odourless powder. Suitable for dry lubrication of car door locks, inside padlocks, and outside padlocks. Non freezing. This item is compatible with all Kasp locks. Does not leave behind a sticky residue. Lubricates locks without attracting dust. Graphite powder has been used in lock maintenance for decades and is recommended over greasy alternatives.

Item No.

K30050



53



10

Product	Page Number	Product	Page Number
Adaptors	247	Pointing Trowel	204
Chuckaway Extension Bar	247	Scraper Blades	205
Clipacore Core Adaptor	247	Sealant Gun	205
Clipacore SDS Drill Adaptor	247	Spring Clamps	204
Drill Adaptor	247	Cabinet Hinges	240
Hex Adaptor	247	Cabinet Hinges - 90°	240
Automotive & Engineering	208	Spring Loaded Cabinet Hinges - 90°	240
Adjustable Wrenches - Standard	208	Spring Loaded Cabinet Hinges - 175°	240
Combination Spanner Set	209	Cable Tackers	62
Socket & Bits Set	208	Cable Staples - Half round	62
Socket Set	208	Cable Tacker - Low Voltage Cable	62
Arbors & Accessories	117	Cable Tacker - Telecom Cable	62
Hole Enlarging Adaptor	117	Telecom Staples - Half Round	62
Holesaw Arbor	117	Cable Tie Guns	61
Holesaw Extension Bar	117	Cable Tie Gun	61
Locking Holesaw Arbor	117	Cable Tie Gun - Heavy Duty	61
Quick Change Arbor	117	Cable & Wire Cutting	61
Quick Release Arbor	117	Electricians Scissors	61
Quick Release SDS+ Arbor	117	Kevlar Scissors	61
Replacement Arbor Pilot Bit	117	Cable & Wire Stripping	58
SDS+ Holesaw Arbor	117	Auto Cable/Wire Stripper	60
Blue Steel Impact Bits	118	Automatic Wire Stripper Pro	60
Blue Steel Impact Bits CBOX	120	Cable Knife	59
Blue Steel Impact Bits - Hex	120	Coax Cable Stripper	59
Blue Steel Impact Bits - PH 25mm	119	DataComms Cable Stripper	59
Blue Steel Impact Bits - PH 50mm	119	Electricians Knife	61
Blue Steel Impact Bits - PZ 25mm	118	Fibre Optic Cable Stripper	60
Blue Steel Impact Bits - PZ 50mm	118	Flat & Round Cable Stripper	59
Blue Steel Impact Bits - Robertson	120	Kabifix Cable Stripper	60
Blue Steel Impact Bits Set/6 - PH	121	Single Core Auto Wire Stripper	59
Blue Steel Impact Bits Set/6 - PZ	120	Universal Cable Stripper	59
Blue Steel Impact Bits Set/6 - TX	121	VDE Cable Sheath Strip Knife	60
Blue Steel Impact Bits Set/10 - PZ/PH	120	Carbofib ESD	87
Blue Steel Impact Bits - SL 25mm	119	Carbofib ESD Fine Tweezers	87
Blue Steel Impact Bits Trade Pack	120	Carbofib ESD Round Tweezers	87
Blue Steel Impact Bits - TX 25mm	119	Carbofib ESD Slim Tweezers	87
Blue Steel Impact Bits - TX Tamperproof	119	Chalk Lines & Accessories	172
Roofing Bolt Driver	121	Chalk Line - Braided Nylon	173
S2 Steel Modulo Bits	121	Chalk Line - Cotton	173
Bradawls	139	Chalk Line Reel and Chalk	172
Bradawl - Round	139	Chalk Powder	173
Bradawl - Square	139	Heavy Duty Chalk Line Reel Set	172
Bricklaying	132	Plumb Bob	172
Brick Jointer	132	Chisels	144
Broad Heel Brick Trowel - Soft Grip	132	Bolster Chisels - Stocked CDU	145
Broad Heel Brick Trowel - Wood Handle	132	Brick Bolster Chisels	144
Philadelphia Brick Trowel - Soft Grip	132	Brick Bolster Chisels with Grip	144
Philadelphia Brick Trowel - Stainless Steel	132	Cold Chisels	145
Philadelphia Brick Trowel - Wood Handle	132	Electricians Bolster Chisel	144
Building & Decorating	204	Electricians Bolster with Grip	144
Broad Heel Brick Trowel	204	Plugging Chisel	145
Collapsible Stool	206	Scutch Chisels	145
Dust Sheet	205	Scutch Chisel - Spare Bits	145
Filling Knife	205	Slaters Ripper	144
General Purpose Scraper	205	Circlip Pliers	25
Plasterers Trowel	205	Circlip Pliers - Adjustable	25

Product	Page Number	Product	Page Number
Circlip Pliers - Inside Bent	25	Digging Spade	235
Circlip Pliers - Inside Straight	25	Lawn Edger	236
Circlip Pliers - Outside Bent	25	Maxima Garden Trowel	236
Circlip Pliers - Outside Straight	25	Maxima Hand Fork	236
Crimping Pliers	18	Maxima Rockery Trowel	236
Auto Bootlace Crimping Plier	19	Mist Spray	236
Bell Mouth Crimper 6-25mm 2K	19	Dextro	37
Coax, BNC, TNC Crimper	20	Dextro Screwdriver Set/5 - SL/PZ	39
Coax, BNC, TNC Crimper 2K	20	Dextro Screwdriver Set/7 - SL/PH	39
Compact Modular Crimper 6/8P	21	Dextro Screwdriver Set/7 - SL/PZ	39
Crimping Pliers	21	Dextro Screwdrivers - Phillips	38
Ferrule Crimper 0.14-2.5mm 2K	19	Dextro Screwdrivers - Pozidriv	37
Ferrule Crimper 0.25-6mm 2K	20	Dextro Screwdrivers - Robertson	38
Ferrule Crimper 10-25mm 2K	19	Dextro Screwdrivers - Slotted Flared	37
Modular Crimper 4/6/8P 2K	19	Dextro Screwdrivers - Slotted Parallel	37
Modular Crimper 6/8P 2K	20	Dextro Screwdrivers - Torx	38
Multi-Function Crimping Plier	21	Dextro VDE	31
Pass Through Modular Crimper 8P 2K	20	VDE Screwdriver Set/2 - Modulo	31
Solar PV Crimper 2K	20	VDE Screwdriver Set/5 - SLP/PH	32
Terminal Crimper 0.5-6mm 2K	18	VDE Screwdriver Set/5 - SLP/PZ	32
Terminal Crimper 1-10mm 2K	19	VDE Screwdriver Set/7 - SLP/PH	32
Terminal Crimper .25-2.5mm 2K	18	VDE Screwdriver Set/7 - SLP/PZ	32
Classic	16	VDE Screwdrivers - Modulo	31
Classic Cable Cutters	17	VDE Screwdrivers - Phillips	31
Classic Combination Pliers	16	VDE Screwdrivers - Pozidriv	31
Classic Heavy Duty Side Cutters	16	VDE Screwdrivers - Slotted Parallel	31
Classic Side Cutters	16	Dextro VDE Slim	32
Classic Snipe Nose Pliers	17	VDE Slim Glo Screwdriver Set	34
Combination Padlocks	252	VDE Slim Interchangeable Screwdriver Set	34
105 Aluminium Combination Padlocks	252	VDE Slim Screwdriver Set	34
110 Brass Combination Padlocks	253	VDE Slim Screwdrivers - Modulo	34
114 Marine Combination Padlocks	253	VDE Slim Screwdrivers - Phillips	34
115 Front Combination Padlock	254	VDE Slim Screwdrivers - Pozidriv	32
116 Disc Combination Padlock	254	VDE Slim Screwdrivers - Slotted	32
117 Heavy Duty Combination Padlock	255	Draw Tapes	54
119 High Security Combination Padlocks	255	5 Spare Blades for ArmourSlice	58
Combination Squares	174	ArmourSlice Evo SWA Cable Stripper	58
Combination Square	174	ArmourSlice SWA Cable Stripper	58
Combination Square - 3 in 1	174	Draw Eye for Draw Tapes - 4mm	55
Heavy Duty Combination Square	174	Draw Tape Lubricant	55
Conduit Cutters	24	Electricians Draw Tape	55
PVC Pipe & Conduit Cutter	24	Electricians Draw Tape Reel	55
Ratcheting Conduit Cutter	24	Flexible Head and Draw Eye - 4mm	55
Ratchet Multifunction Cutter	24	Gloworm Cable Router	54
Core Drill Bits	244	Nylon Draw Tapes	55
XPRESSCUT Core Drill Bits	244	POM Draw Tape - 30m	55
Core Drill Kits	244	SpiraFLEX Draw Tapes	54
XPRESSCUT Pro Case Kit	244	Steel Wire Draw Tape - 50m	54
Core Sets	245	Drill Sets	245
Condensemate	246	The Boss Drill	245
Duocut	245	Ecotronic ESD	84
Fluemate	246	Ecotronic Bent Snipe Nose Pliers	86
Cultivating	235	Ecotronic Flat Nose Pliers	86
Border Fork	236	Ecotronic Long Snipe Nose Pliers	86
Border Spade	235	Ecotronic Micro Side Cutters	84
Digging Fork	235	Ecotronic Relieved Side Cutters	85

Product	Page Number	Product	Page Number
Ecotronic Reverse Side Cutters	84	Contractor Organiser	196
Ecotronic Short Snipe Nose Pliers	86	Funnels	167
Ecotronic Side Cutters	85	AT Auto Lock Tape Measure	170
Ecotronic Side Cutters	86	Metal Funnel	167
Ecotronic Slim Side Cutters	85	Plastic Funnel	167
Electrical Installation	63	Softech Tape Measures	170
Conduit Bush Wrench	63	XT Tape Measures	170
MC4 Solar Spanners	63	Glue Guns	138
Punch Down Tool	63	Glue Gun	138
SWA Gland Wrench	63	Glue Gun Kit	138
Engraving	282	Glue Sticks	139
Engraving	282	Grease Guns	167
ESD Wire Stripping Pliers	86	Grease Gun and Accessories	167
ESD Wire Stripper Pliers	87	Hacksaws	149
ESD Wire Stripping Pliers	86	Hacksaw Blades	149
ESD Wire Stripping Pliers	87	Heavy Duty Hacksaw	149
Extension Kits	246	Heavy Duty Quick Change Hacksaw	149
Chuckaway Drill Adaptor	247	Heavy Duty Ripping Saw	149
Chuckaway Extension Kit	246	Junior Hacksaw	150
Clipacore Hex Driver Extension	246	Junior Hacksaw Blades	150
Clipacore SDS Driver Extension	246	Mini Hacksaw	150
Fast4 Fluted Bits	110	Mini Hacksaw & Mitre Box	150
Fast4Access Wood Drill Bits	110	Quick Change Hacksaw	149
Fast4Nails Wood Drill Bits	110	Technicians Hacksaw	149
Fast4 SDS+ Wood Drill Bits	110	Hammers	142
Fast4 Wood Drill Bits	110	Ball Pein Hammer	143
Feeler Gauges	175	Brick Hammers	143
Feeler Gauges	175	Claw Hammers - Anti-Vibration Fibreglass	142
Felling & Lopping	233	Claw Hammers - Anti-Vibration One Piece	142
Hatchets	235	Claw Hammers - Hi-Vis	142
Legend Anvil Loppers	234	Club Hammer - Anti-Vibration One Piece	142
Legend Bypass Loppers	234	Club Hammers	143
Legend Heavy Duty Bypass Loppers	233	Electricians Hammer - French Pattern	143
Maxima Heavy Duty Bypass Loppers	234	Engineers Hammer - French Pattern	142
Maxima Lightweight Bypass Loppers	234	Engineers Hammer - German Pattern	142
Maxima Telescopic Loppers	234	Japanese Prybar	144
Steel Hatchets	234	Joiners Hammer	143
Fencing Pliers	27	Mortar Pick	143
Fencing Pliers	27	Pin Hammer	143
Files & Rasps	152	Hasps & Staples	273
Chainsaw Files	154	210 Traditional Hasp & Staples	273
Engineers Files	152	230 Universal Hasp & Staples	274
Extra Slim Saw File	154	260 Hasp & Staple for Disk Lock	274
File/Rasp	153	HD Classic	45
Flat Bastard Engineers File	152	HD Long Screwdrivers - Phillips	46
Flat Smooth Engineers Files	153	HD Long Screwdrivers - Pozidriv	46
Half Round Engineers Files	153	HD Long Screwdrivers - Slotted Parallel	45
Mills Saw File	153	HD Nut Spinners	47
Needle File Set	155	HD Screwdriver Bit Holder	47
Round Engineers Files	154	HD Screwdriver Set/8 - SLF/PZ	47
Saw File	153	HD Screwdrivers - Phillips	46
Slim Saw File	154	HD Screwdrivers - Pozidriv	46
Warding Files	154	HD Screwdrivers - Slotted Flared	45
Warding File Set	154	HD Screwdrivers - Slotted Parallel	45
Wood Rasps	153	HD Screwdrivers - Strike Through	45
Folders	196	HD Stubby Screwdrivers - Phillips	46

Product	Page Number	Product	Page Number
HD Stubby Screwdrivers - Pozidriv	47	Hose Connector - Water Stop	179
HD Stubby Screwdrivers - Slotted	46	Hose Repairers	178
Head Torches	187	Tap Connector - 2 Way	180
Beanie Hat - USB Rechargeable	187	Tap Connectors - Push-On	180
Head Torch with Motion Sensor	187	Tap Connectors - Threaded Female	179
Head Torch with Rear Red Light	187	Tap Connectors - Threaded Male	179
LED Head Torch USB - Twin Pack	187	Hose Pipes	181
Wide Field Headlight	187	C.K MAXI LED Inspection Light	184
Heavy Duty Cutters	22	C.K MIDI LED Inspection Light	184
Bolt Cutters	23	C.K MINI LED Inspection Light	184
Bolt Cutters - Pocket	23	Multi-Flex Hose Pipes - 1/2"	181
Heavy Duty Cable Shears	22	Pro-Flex Hose Pipes - 1/2"	181
Heavy Duty Ratchet Cable Cutter	22	Pro-Flex Hose Pipes - 3/4"	181
Ratchet Cable Cutter	22	Impact Drivers	43
Wire Cutters - Heavy Duty	22	Impact Screwdriver & Bits Set	43
Wire Rope Cutter	22	Inspection Lights	184
Hexagon Keys	165	Compact Inspection Light - USB	185
Coloured Hex Key Set/9	166	Mini Inspection Light - USB	185
Hexagon Key Clip Set/9	166	Neck Light - 300lm	185
Hexagon Key Clip Set/10	166	Inspection Mirrors	167
Hexagon Key Folding Set/8	166	Inspection Mirror - Extra Long	167
Hexagon Keys - Metric	165	Inspection Mirrors - Telescopic	167
Hexagon Key TX Tamperproof Set	166	Jigsaw Blades	128
Tap & Die Set/21 - Metric	167	Coarse Cut Blade - Wood	128
Hexagon Keys	65	Curved Cut Blade - Wood	129
Insulated T Handle Hex Keys	65	Double Cut Blade - Wood	129
Insulated T Handle Hex Key Set	65	Down Cut Blade - Laminate	129
Holesaws	114	Fast Cut Blade - Wood	128
Adjustable Hole Cutter	116	Fast Fine Cut Blade - Wood	129
Downlight Hole Saw Kit - 6 Piece	115	Fine Cut Blade - Metal	129
Electricians Hole Saw Kit - 9 Piece	115	Fine Cut Blade - Wood	128
Holesaw Display - Stocked Stand	115	Reciprocating Saw Blades	129
Holesaw Kit - 6 Piece	115	Straight Cut Blade - Metal	128
Holesaw Kit - 9 Piece	115	Straight Cut Blade - Thick Metal	128
ProCobalt Holesaws	114	Straight Cut Blade - Universal	129
Sheet Steel Holesaw Display	116	Joiners Bevels & Squares	173
Sheet Steel Holesaws	116	Joiners Square - Beech	174
Sheet Steel Holesaw Set/3	116	Joiners Square - Rosewood	173
TCT HoleSaw Pilot Bit & Spring (3pc)	116	Marking Gauge - Beech	174
TCT Hole Saws	116	Marking Gauge - Rosewood	173
Hoof Cutters	236	Sliding Bevel - Beech	174
Hoof Cutter	236	Sliding Bevel - Rosewood	173
Hoof Cutter - Serrated	237	Keyed Padlocks	258
Hose Accessories	180	120 Brass Padlocks	258
Adjustable Spray Gun	180	124 Coloured Brass Padlocks	259
Adjustable Spray Nozzle	180	125 Premium Brass Padlocks	260
Lawn Sprinkler - Oscillating	181	125 Series Component Parts	262
Lawn Sprinklers - Pulse Jet	181	130 Laminated Steel Padlocks	263
Rose Spray	180	135 Harsh Environment Padlocks	264
Spare O-Rings	180	140 Solid Aluminium Padlocks	264
Hose Connectors	178	145 Marine Padlocks	265
Hose Connector Display	178	150 Stainless Steel Padlock	266
Hose Connector - Male & Female	179	160 Disc Padlocks	267
Hose Connectors	179	180 Hardened Steel Padlocks	268
Hose Connectors - Female	179	180 Series Component Parts	269
Hose Connectors - Male	178	190 High Security Padlocks	270

Product	Page Number	Product	Page Number
190 Series Component Parts	271	Jokari PWS-PLUS 003	225
Keys	281	Jokari QUADRO Plus	224
Cut Keys	282	Jokari SECURA 2K	215
Key Blanks	281	Jokari SECURA Coaxi No. 1	218
Key Safes	256	Jokari SECURA No. 15	217
600 Combination Key Safe	256	Jokari Sensor Mini	215
601 Combination Key Safe	256	Jokari Sensor Special	215
Kitchen Accessories	240	Jokari SE-Strip 1.5mm	219
Gas Lighter	240	Jokari SE-Strip 2.5 - 6mm	219
Waiters Friend Bottle Opener	240	Jokari SE-Strip 11 - 13mm	219
Knives	237	Jokari Spare Cable Blade	222
Lambsfoot Knives	237	Jokari Spare Hook Blade	223
Locking Knife - Clip Point	237	Jokari Special	216
Locking Knife - Lambsfoot	237	Jokari Strip No. 14	217
Pocket Knife - Spear Point	237	Jokari Super 4 Plus	214
Lighting	211	Jokari SW11 - Top Coax	216
Jokari Allrounder	219	Jokari SWS-PLUS 012	224
Jokari AS Interface Pro	214	Jokari SWS-PLUS 016	225
Jokari AS-Interface Strip	218	Jokari SWS-PLUS 020	226
Jokari Cable Bracket No. 16	223	Jokari SWS-PLUS 025	226
Jokari Cable Bracket No. 28	223	Jokari SWS-PLUS 030	226
Jokari Cable Bracket No. 35	223	Jokari SWS-PLUS 040	226
Jokari Cable Bracket No. 50	223	Jokari SWS-PLUS 050	226
Jokari Cable Bracket No. 70	223	Jokari SWS-PLUS 060	226
Jokari Cable Knife 4-70 Set	222	Jokari SWS-PLUS 080	227
Jokari Cable Knife System 4-70	222	Jokari SWS-PLUS 100	227
Jokari CAN-Strip	216	Jokari Top Coax Plus	216
Jokari ESD-PLUS 001	225	Jokari UNI-Plus	218
Jokari ESD-PLUS 002	225	Jokari Universal No. 12	216
Jokari ESD-PLUS 003	225	JOKARI XL	216
Jokari Ferrules	224	Site Lamp	211
Jokari Fibre Strip DC	218	Locking Bolts	257
Jokari Fibre Strip LC	218	620 Combination Locking Bolt	257
Jokari Flat Cable Stripper	214	Lubrication	283
Jokari High Strip	215	Microfibre Graphite Powder	283
Jokari LC-PUR	219	Magnetiser / Demagnetiser	43
Jokari Locator Box	219	Magnetiser/Demagnetiser	43
Jokari No.1-Cat	218	Mainstesters	63
Jokari No. 6-16	215	Heavy Duty Mainstester - 120-250V AC	63
Jokari No. 16 SECURA	220	Long Mainstester - 120-250V AC	63
Jokari No. 16 Standard	220	Mainstester - 120-250V AC	63
Jokari No. 27 SECURA	220	VDE Mainstester - 125-250V AC	63
Jokari No. 27 Standard	221	VDE Mainstester - Pocket Clip	63
Jokari No. 28G SECURA	221	Marking & Measuring	209
Jokari No. 28G Standard	221	Heavy Duty Tape Measures	209
Jokari No. 28H SECURA	221	Pocket Level	209
Jokari No. 28H Standard	221	Socket Box Template	209
Jokari No. 35	221	Spirit Level	209
Jokari No. 35P	222	Tape Measure	209
Jokari No. 50	222	Masonry Drill Bits	106
Jokari No. 70	222	Masonry Colour Drill Bit Sets	108
Jokari Outlet Special 20	215	Masonry Drill Bits	107
Jokari PC-CAT	218	Masonry Drill Bit Set/5	107
Jokari PC-Strip	217	Masonry Drill Bit Set/25	108
Jokari PWS-PLUS 001	224	Masonry Hex Drill Bit Set/5	107
Jokari PWS-PLUS 002	224	SDS+ Concrete Drill Bits	106

Product	Page Number	Product	Page Number
SDS Concrete Drill Bit Set/7	106	Power Paint Mixer	137
SDS Flat Chisel Bits	106	Pens & Pencils	175
SDS Masonry & Chisel Set/15	107	Carpenters Pencil	175
SDS Masonry Drill Bit Set/14	106	Professional Marker Pen	175
SDS Point Chisel Bit	106	Pincers & Top Cutters	23
Metal Drill Bits	108	Pincers	23
Cobalt Split Point Drill Bit Set	109	Top Cutters - Standard	23
High Speed Steel Cone Drills	109	Top Cutters - Steel Fixers	23
HSS Multi-Step Drills	109	Pipe Cutters	24
HSS Split Point Drill Bits	108	Mini Pipe Cutter	24
HSS Split Point Drill Bit Set/6	109	Pipe Cutter	24
HSS Split Point Drill Bit Set/13	109	Pipe Cutter - Spare Wheel	24
HSS Split Point Drill Bit Set/19	109	Plasterboard Saws	150
TiN Coated Multi-Step Drill	109	Plasterboard Saw	151
MightyRods	52	Sabretooth 2-Sided Plasterboard Saw	150
MightyRods 3.3m Cable Rods Set	54	Sabretooth Plasterboard Saw	150
MightyRods 10m Cable Rods Set	52	Plastering	133
MightyRods Carry Case	54	Finishing Trowel - Soft Grip	133
MightyRods PRO	51	Finishing Trowel - Wood Handle	133
MightyRods 3pc Accessory Pack	51	Leaf & Square Tool	133
MightyRods 7pc Accessory Pack	52	Plasterers Hawk	133
MightyRods PRO 3.3m Toolbox Set	51	Skimmer Floats	133
MightyRods PRO 4mm SpiraFLEX	52	Trowel & Square Tools	133
MightyRods PRO 5m Starter Set	51	Plastic Trimmers	101
MightyRods PRO 6mm Rod - GLO	52	Plastic Trimmer Set/7	101
MightyRods PRO 6mm Rods - 2 Pack	52	Plastic Trimmer Set/10	101
MightyRods PRO 7mm Rods - 2 Pack	52	Pliers & Cutters	202
MightyRods PRO 10m Standard Set	51	Combination Pliers	202
MightyRods PRO 12m Super Set	51	Insulated Pliers Set	202
MightyRods PRO Cable Socks	51	Multi-Purpose Snips	202
MightyScope	52	Side Cutters	202
MightyScope Inspection Camera	52	Waterpump Pliers	202
Milling Cutters	240	Plumbing	138
End Mill Cutter	240	Basin Wrench	138
Multi-Material	113	Immersion Heater Spanner	138
Combination Drill Bit Set	113	Stillson Wrench	138
Glass/Tile Drill Bit Set	113	Pocket Balances	175
TiN Drill Bit Set/6	113	Pocket Balances	175
TiN Drill Bit Set/19	113	Power Tool Accessories	203
TiN Drill Saw - Twin Pack	113	Angle Driver	204
Universal Drill Bit Set	113	Flat Drill Bit Set	204
Multisaws	150	HSS Drill Bit Set	204
Multi-Saw	150	Masonry Drill Bit Sets	203
Multitool Blades	127	Power Tool Spares	247
Multitool Blade - 2 Piece Set	128	A Taper Guide Pin	247
Multitool Blade - 5 Piece Set	128	A Taper Pilot Drill	247
Multitool Blade - Box Cutter	127	Clipacore Spare Clips	247
Multitool Blade - Carbide	127	Knock Out Tool	247
Multitool Blade - Scraper	127	PPE	210
Other	103	Cover Spectacles	210
ESD Ball Pen	103	Ear Defenders	210
ESD Desoldering Tool	103	Gripper Gloves	211
ESD Desoldering Tool Nozzle	103	Hard Hat	210
Magnetic Pickup Pointer & Pen	103	Hi-Vis Vest	211
PLCC Extractor	103	Nitrile Gloves	211
Paddles & Mixers	137	PU Gloves	211

Product	Page Number	Product	Page Number
Wraparound Glasses - Anti-Mist	210	Black Tweezers - Guide Pin	89
Wraparound Glasses - Clear	210	Blunt Universal Tweezers	88
Wraparound Glasses - Tinted	210	Ceramic Straight Tweezers	90
Precision Ceramic Trimmers	100	Cross Pattern Tweezers	89
Ceramic Trimmers - 4 in 1	101	Curved Precision Tweezers	90
Ceramic Trimmers - Phillips	100	Extra Long Tip Tweezers	89
Ceramic Trimmers - Slotted	100	Fine Straight Tweezers	89
Precision ESD Tweezers	92	Fine Straight Tweezers	90
ESD Curved Positioning Tweezers	93	Fine Universal Tweezers	88
ESD Extremely Fine Tweezers	93	Flat Blunt Precision Tweezers	91
ESD Fine Curved Tweezers	93	Flat Sharp Precision Tweezers	91
ESD Fine Precision Tweezers	93	Flat Tip Tweezers	91
ESD Long Superfine Tweezers	93	Long Straight Tweezers	89
ESD Oblique Tweezers	93	Offset & Angled Tweezers	90
ESD Positioning Tweezers	93	Positioning Tweezers	90
ESD Precision Tweezers	92	Radio Tweezers - Bent	90
ESD Precision Tweezers	92	Radio Tweezers - Straight	89
ESD Precision Tweezers	92	Reverse Cross Pattern Tweezers	91
ESD Precision Tweezers	92	Round Positioning Tweezers	91
ESD Precision Tweezers	92	Round Positioning Tweezers	91
ESD Precision Tweezers	92	Round Positioning Tweezers	91
ESD Round Positioning Tweezers	93	Sharp Precision Tweezers	90
ESD Smooth Tip Tweezers	93	Straight Fine Tip Tweezers	91
ESD Very Sharp Tweezers	93	Strong Flat Precision Tweezers	91
Precision Pliers & Cutters	80	Superfine Straight Tweezers	90
Precision Bent Snipe Nose Pliers	83	Tweezers - Guide Pin	89
Precision Bent Snipe Nose Pliers	83	Universal Cross-Cut Tweezers	89
Precision Bevel Side Cutters	82	Universal Tweezers	88
Precision Flat Nose Pliers	83	Precision Wire Strippers	102
Precision Flat Nose Pliers	83	Adjustable Precision Wire Stripper	102
Precision Full Flush Side Cutters	81	ESD Precision Wire Stripper	102
Precision Needle Nose Pliers	84	ESD Wire Stripper Spares	103
Precision Oblique Cutters	82	Fibre Optic Stripper	102
Precision Oblique Cutters	82	Precision Wire Stripper	102
Precision Oblique Tip Cutters	82	Strip Cut Wire Stripper	102
Precision Oval Head Cutters	82	Pruning	232
Precision Pliers Set - 6 Piece	84	Folding Pruning Saws	233
Precision Round Nose Pliers	84	Legend Bypass Pruners	232
Precision Side Cutters	80	Legend Heavy Duty Bypass Pruners	232
Precision Side Cutters	80	Legend Power Pruners	232
Precision Side Cutters	81	Locking Pruning Knife	233
Precision Side Cutters	81	Long Pruning Saw	233
Precision Snipe Nose Pliers	83	Maxima Anvil Pruners	232
Precision Snipe Nose Pliers	83	Maxima Bypass Pruners	232
Precision Top Cutters	82	Maxima Pruning Snips	233
Precision Wire Stripping Pliers	84	Maxima Ratchet Pruners	232
Precision Screwdrivers	100	Pruning Knife	233
Screwdriver Set/7 - SL/PH/TX	100	Punches	145
VDE Screwdriver Set/7 - SL/PH	100	Centre Punches	145
Watchmakers Screwdriver Set/4 - SL	100	Pin Punches	145
Watchmakers Screwdriver Set/6 - SL/PH	100	Plasterboard Punch	145
Precision Tweezers	88	Sabretooth Wood Saw	148
Angled Positioning Tweezers	90	Punch Pliers	27
Angled Tweezers	90	Revolving Punch Pliers	27
Bent Positioning Tweezers	91	Ratchet Screwdrivers	43
Bent Tweezers	89	Ratchet Screwdriver & Bits Set	43
Black Fine Universal Tweezers	88		

Product	Page Number
Ratchet Screwdriver/Socket Set	43
Reciprocating Blades	129
RedLine	13
Cutter, Snipe & Combination Pliers Set	15
Cutter, Snipe & Stripping Pliers Set	15
Redline Bent Nose Pliers	15
Redline Cable Cutters	13
Redline Combination Pliers	15
Redline High Leverage Side Cutter	13
Redline Side Cutter	13
Redline Snipe Nose Pliers	15
Redline Wire Stripper	15
RedLine VDE	11
RedLine VDE Cable Cutters	11
VDE Cable Cutters	12
VDE Combicutter1	11
VDE Combicutter1 Max	11
VDE Combicutter2	11
VDE Combicutter3	11
VDE Combicutter3 Max	11
VDE Combination Pliers	12
VDE Electricians Pliers	12
VDE High Leverage Side Cutter	12
VDE Pliers Set - 3 Piece	13
VDE Side Cutter	12
VDE Snipe Nose Pliers - Bent	13
VDE Snipe Nose Pliers - Straight	12
VDE Wire Stripping Pliers	13
VDE Wire Stripping Side Cutter	11
Replacement Parts	235
Felling Axes	235
Spares for Shearers, Pruners & Loppers	235
Rescue Sets	164
Damaged Hex Bolt Rescue Set	164
Damaged Nut Extractor Set	164
Re-Threading Tools	65
Re-Threading Tools	65
Riveting Pliers	26
Lazy Tong Riveter	26
Riveting Pliers	26
Riveting Plier Nozzles	26
Rivets - Aluminium (Pack of 50)	27
Washers (Pack of 100)	27
Rules	172
Folding Rule	172
Steel Rules	172
Straight Edge Rule	172
Sawing, Cutting & Filing	207
Coping Saw	207
Hacksaw	207
Mini Hacksaw	207
Tri-Cut Handsaw	207
Trimming Knife - Auto-Load	208
Trimming Knife Blades - Standard	208
Trimming Knife - Retractable	208
Wood Chisel Sets	207

Product	Page Number
Scissors	237
Cut Out Scissors	238
Embroidery Scissors	239
Hairdressing Scissors	238
Kitchen Scissors	239
Ladies Scissors - Modern	239
Ladies Scissors - Traditional	238
Nail Scissors - Curved Blades	239
Nail Scissors - Straight Blades	238
Pocket Scissors	238
Tailors Shears	237
Trimmer Scissors - Modern	239
Trimmer Scissors - Serrated	239
Trimmer Scissors - Traditional	238
Scrapers & Filling Knives	137
Filling Knife	137
Putty Knife	137
Scrapers	137
Scrapers / Filling Knives	137
Screwdriver Bit Holders	126
Keyless Chuck Adaptor	127
Locking Bit Holder	126
Magnetic Bit Holders	126
Magnetic Nut Drivers Set/7	127
Nut Driver - Magnetic	126
Pivot Joint Bit Holder	126
Quick Change Chuck System	127
Screw Grip Magnetic Bit Holder	126
SDS+ Bit Holder	126
Screwdriver Bits	121
Damaged Screw Removers	125
Screwdriver Bit Box Set/7	123
Screwdriver Bit Clip Set/7 - PH	123
Screwdriver Bit Clip Set/7 - PZ	123
Screwdriver Bit Clip Set/7 - TX	123
Screwdriver Bit Clip Set/31	123
Screwdriver Bits CBOX - PZ	125
Screwdriver Bits - Hex	122
Screwdriver Bits - PH Long	121
Screwdriver Bits - PZ Long	121
Screwdriver Bits Set/8 - Hex	124
Screwdriver Bits Set/8 - Hex Tamperproof	124
Screwdriver Bits Set/8 - PZ/PH	124
Screwdriver Bits Set/8 - Slotted	124
Screwdriver Bits Set/8 - Torx	124
Screwdriver Bits Set/8 - Torx Tamperproof	124
Screwdriver Bits Set/10 - Long	125
Screwdriver Bits Set/33 - Mixed	124
Screwdriver Bits Set/41	125
Screwdriver Bits - Slotted	121
Screwdriver Bits - Torx	122
Screw Extractor Set/5	125
Security Bits Set/41	125
TiN Double Ended Bits - PH/Slotted	122
TiN Screwdriver Bits CBOX - PZ	126
TiN Screwdriver Bit Set/7 - PZ	123
TiN Screwdriver Bits - PH Long	122

Product	Page Number	Product	Page Number
TiN Screwdriver Bits - PZ Long	122	Maxima Light Weight Hedge Shears	230
TiN Screwdriver Bits - Torx	122	Maxima Long Reach Hedge Shears	231
Screwdrivers	203	Shutter Locks	272
Insulated Screwdriver Set	203	170 Brass Shutter Locks	272
Precision Screwdriver Set	203	175 Armoured Shutter Locks	272
Screwdriver Sets	203	Site Lights	186
Stepless Ratchet Driver Set	203	10W Rechargeable Site Light	186
Stepless Ratchet Screwdriver	203	COB Power Tool Battery Site Lights	186
Security Cables & Chains	275	Snap Hooks	241
450 Series Security Chains	275	Heavy Duty Snap Hooks with Swivel Ring	241
455 Double Loop Security Cable	275	Heavy Duty Snap Hook with Key Ring	241
470 Combination Chain Lock	276	Wide Snap Hook with Swivel Eye	241
475 Combination Cable Lock	276	Snips	26
Security Lock-Off	277	Cable Snips	26
120 Brass Padlock - Lock-Off	277	Compound Action Snips	26
200 Lock-Off Hasps	277	Tin Snips	26
205 Lock-Off Hasps	278	Soldering	65
800 Nylon Safety Padlocks	277	Professional Tool Kit	68
810 Easifit MCB Lock-Off	278	Soldering Irons	65
811 Essential Lockout Kit	279	Soldering Wire	65
812 MCB Lockout - Pin Out Wide	279	Spanners	162
813 Electrical Lockout Kit	280	Colour Coded Spanner Set/12	163
SensoPlus ESD Pliers & Cutters	76	Combination Spanners	162
ESD Bent Snipe Nose Pliers	79	Combination Spanner Set/10	163
ESD Bent Snipe Nose Pliers	79	Combination Spanner Set/12	163
ESD Bevel Side Cutter	77	Metric Ratchet Spanner Set/7	163
ESD Bevel Wire Catch Side Cutter	77	Speed Spanners Set/6	163
ESD Flat Nosed Pliers	79	Spirit Levels	171
ESD Needle Nose Pliers	80	Box Section Spirit Levels	171
ESD Oblique Cutters	78	Pocket Level	171
ESD Oblique Cutters	78	Staple Guns	139
ESD Oblique Cutters	78	Staple & Nail Gun	139
ESD Oblique Cutters	78	Staples - Square	139
ESD Oblique Tip Cutters	78	Striking Tools	206
ESD Oval Head Cutter	77	Brick Bolster	207
ESD Pliers Set - 6 Piece	80	Claw Hammers - Fibreglass	206
ESD Round Nosed Pliers	80	Club Hammer	206
ESD Side Cutter	76	Electricians Bolster	206
ESD Side Cutter	76	Sledge Hammers	206
ESD Side Cutter	77	Wrecking Bars	206
ESD Side Cutter	77	Stubby VDE Slim	35
ESD Side Cutter	77	Stubby VDE Slim Screwdriver - Modulo	35
ESD Snipe Nose Pliers	79	Stubby VDE Slim Screwdriver - Pozidriv	35
ESD Snipe Nose Pliers	79	Stubby VDE Slim Screwdriver Set/4	35
ESD Tool Kit	80	Stubby VDE Slim Screwdrivers - Slotted	35
ESD Top Cutters	78	Sure-Drive	159
ESD Top Cutters	79	24 Tooth Ratchet Handle - 1/2" Drive	159
ESD Tungsten Carbide Side Cutter	76	45 Tooth Ratchet Handle - 1/2" Drive	159
Shearing	230	Bi-Hex Sockets - 1/2" Drive	159
Adjustable Lawn Edging Shears	231	Coloured 1/4" Socket Set/17	160
Heavy Duty Lawn Edging Shears	231	Coloured 3/8" Socket & Spanner Set	161
Legend Golden Hedge Shears	230	Flexible Handle - 1/2" Drive	159
Legend Multi-Purpose Shears	231	Long Extension - 1/2" Drive	160
Legend Silver Hedge Shears	230	Pocket Socket Set - 1/4" Drive	160
Maxima Grass Shears	231	Short Extension - 1/2" Drive	160
Maxima Lawn Edging Shears	231	Sliding T-Handle - 1/2" Drive	159

Product	Page Number	Product	Page Number
Socket Accessory Stand	160	Electricians Apprentice Kit	69
Socket Set/22 - 1/2" Drive	161	Electricians Service Case	71
Socket Set/23 - 3/8" Drive	161	Electrician's Tool Kit - European	68
Socket Set/36 - 1/4" Drive	160	Essential Tool Kit	70
Socket Set/39 - 1/4" Drive	161	EV Charging Point PTA Kit	69
Torque Wrench - 1/2" Drive	159	EV Charging Point Tool Kit	68
Universal Joint - 1/2" Drive	160	Professional Plus Tool Kit	68
Switch Keys	64	Solar Installer Tool Kit	69
Cabinet Cross Key - 12 in 1	64	Technicians Tool Kit	70
Cabinet Wrench Key - 8 in 1	64	VDE Pliers & Screwdrivers Kit - PH	70
Universal Switch & Cabinet Key	64	VDE Pliers & Screwdrivers Kit - PZ	70
Universal Switch Key - 9 in 1	64	Tool Rolls	196
Tap & Die	167	Chisel Roll	196
Tape Measures	170	Tool Roll	196
Fibreglass Measuring Tape	171	Tool Storage	71
Steel Measuring Tape	171	Electronic Service Case	71
Surveyors Tapes	171	Rigid Service Case	71
Technicians Rucksacks	190	Tool Wallet	71
Technicians Rucksack	190	Tool Totes	194
Technicians Rucksack Plus	190	3in1 Tote	195
Wheeled Rucksack	190	18" Open Tool Tote	195
Tiling & Glazing	136	Technicians Tote	194
Adhesive Trowels	136	Tool Tote	194
Glass Cutter	136	Tool Vests & Rigs	199
Grouting Float	136	Belt Conversion Kit	199
Grouting Sponge	136	Braces	199
Suction Lifter - 60kg	136	Technicians Vest	199
Tile Scriber	136	Trimming Knives	151
Tool Bags	191	Folding Utility Knife	151
Maxi bag	191	Multifunction Knife	151
Mini Bag	191	Safety Trimming Knife	151
Tool Belts & Accessories	196	Snap Off Trimming Knife	152
3 Pocket Pack	199	Snap Off Trimming Knife - 9mm	152
Compact Padded Belt	196	Soft Grip Trimming Knives	151
Essential Pouch	196	Spare 9mm Trimming Knife Blades	152
Hammer Loop	198	Spare Snap Off Blades	152
Knife Holder	198	Spare Trimming Knife Blades	152
Mobile Phone Pouch	198	Trimming Knives	151
Nail Pouch	197	Triton ESD	94
Tape Measure Holder	198	ESD Bit Holder/Driver	95
Toolbelt Set	196	ESD Screwdriver Set/6 - SL/PH/TX	95
Universal Drill Holster	197	ESD Screwdriver Set - Torx Tamperproof	95
Universal Pouch	197	ESD Screwdrivers - Phillips	94
Tool Cases	192	ESD Screwdrivers - Pozidriv	94
Technicians Pro Wheeled Case	193	ESD Screwdrivers - Slotted Parallel	94
Technicians Tool Case	192	ESD Screwdrivers - Torx Tamperproof	95
Technicians Toolcase Max	193	Triton ESD Screwdriver Set	95
Technicians Tool Case Plus	192	Triton XLS	41
Technicians Wheeled Toolcase	193	Electric Torque Screwdriver	42
Test Equipment Case Plus	194	Flexible Shafted Screwdriver	41
Test Meter Case	194	Insulated Triton Set/5 - SL/PH	42
Toolcase Plus	193	Insulated Triton Set/5 - SL/PZ	42
Toolkits	68	Triton Screwdriver Bit Holder	41
Complete Tool Kit	69	Triton Screwdriver Set/5 - SL/PH	42
Contractor Tool Kit	70	Triton Screwdriver Set/5 - SL/PZ	42
Core Tool Kit	70	Triton Screwdrivers - Phillips	41

Product	Page Number	Product	Page Number
Triton Screwdrivers - Pozidriv	41	Auger Wood Bits - Standard	112
Triton Screwdrivers - Slotted Flared	41	Countersink Bit	112
Triton Screwdrivers - Slotted Parallel	41	Flat Bits - Long Stocked Display	111
Trowels	134	Flat Wood Bit Extension Drive	111
Edging Trowel	135	Flat Wood Bits	111
Finger Trowel - Soft Grip	134	Flat Wood Bits Set	111
Finger Trowels - Wood Handle	134	Heavy Duty Flat Wood Bits	111
Flooring Trowel	135	Quick Release Extension Bar - 3 Pack	111
Gauging Trowel - Soft Grip	134	Wood Drill Bits	112
Gauging Trowel - Stainless Steel	135	Wood Drill Bit Set/5	112
Gauging Trowel - Wood Handle	134	Wood Saws	148
Harling Trowel	135	Sabretooth Trade Fine Cut Wood Saw	148
Margin Trowel	135	Sabretooth Trade Universal Wood Saw	148
Pointing Trowel - Soft Grip	134	Wrecking Tools	144
Pointing Trowel - Stainless Steel	135	Prybar, Nail Puller & Scraper	144
Pointing Trowels - Wood Handle	134	Wrenches	164
Van Locks	273	Adjustable Wrenches - Sure-Drive	164
500 Van Lock & Hasps	273	Adjustable Wrenches - Wide Jaw	165
Vernier Calipers	175	Self Grip Wrench - Concave Jaws	165
Vernier Caliper	175	Self Grip Wrench - Straight Jaws	165
Voltage Detectors	64	Self Grip Wrench - V-Jaws	165
Voltage Detector - Visual	64	Xonic ESD	96
Voltage Detector - Visual & Audible	64	ESD Screwdriver - Phillips	96
Waterpump Pliers	17	ESD Screwdrivers - Pozidriv	96
Heavy Duty Waterpump Pliers	17	ESD Screwdrivers - Torx	97
High Capacity Waterpump Pliers	18	Xonic Nut Spinner	97
Push Button Waterpump Pliers	17	Xonic Screwdriver Set/4	97
Waterpump Pliers	17	Xonic Screwdriver Set/7	97
Waterpump Pliers - Standard	17	Xonic Screwdrivers - Hex	97
Wire Brushes	167	Xonic Precision Screwdrivers	98
Wire Brush	167	Xonic Precision Screwdrivers - Phillips	98
Wood Chisels	155	Xonic Precision Screwdrivers - Slotted	98
Sharpening Stone	155	Xonic Precision Screwdrivers - Torx	99
Wood Chisels	155	Xonic Screwdriver Set/4	99
Wood Chisel Set	155	Xonic Screwdriver Set/5	99
Wood Chisel Stand	155	Xonic Screwdriver Set/7	99
Wood Drill Bits	111	Xonic Screwdriver Set - Hex	99
Auger Wood Bits - Long	112	Xonic Screwdriver Set - Torx	99
Auger Wood Bits - Short	112		

Product	Page	Product	Page	Product	Page	Product	Page
20300	215	424039	117	495010	65	AV05021	203
316001	71	424040	117	495011	65	AV05050	203
330009	102	424041	117	495012	65	AV06010	202
330011	102	424042	117	495013	65	AV06020	202
330012	102	424043	115	495014	65	AV06030	202
330013	102	424044	115	495015	64	AV06040	202
356001	143	424045	115	495021	62	AV06051	202
356002	142	424046	115	495022	62	AV07010	208
356003	142	424047	117	495024	62	AV07011	208
357001	142	424048	117	495028	65	AV07020	209
357002	142	424049	117	495029	65	AV07030	208
357003	142	424050	114	495033	63	AV07031	208
357004	142	424060	114	495050	55	AV08010	203
357005	142	430001	24	495051	55	AV08011	204
395041	60	430003	24	495052	55	AV08012	203
400002	115	430004	60	495053	55	AV08013	204
406001	145	430005	21	495054	55	AV08014	203
406002	145	430006	21	495055	54	AV08015	203
422001	121	430007	22	495056	55	AV08020	204
422003	125	430008	26	495057	55	AV09010	207
424001	114	430009	60	495058	55	AV09011	207
424002	114	430024	21	495059	55	AV09020	207
424003	114	430026	20	496001	139	AV09030	207
424005	114	431001	12	496002	139	AV10010	207
424006	114	431002	12	496003	139	AV12010	204
424007	114	431003	12	496004	139	AV12011	204
424008	114	431004	11	496005	139	AV12012	204
424010	114	431005	12	AV00010	206	AV12020	205
424011	114	431008	11	AV01001	208	AV12021	205
424012	114	431009	11	AV01010	208	AV12025	205
424013	114	431012	13	AV01090	208	AV12030	205
424014	114	431013	12	AV02001	209	AV12040	205
424015	114	431014	12	AV02010	209	AV13012	210
424016	114	431015	13	AV02011	209	AV13020	210
424017	114	431017	12	AV02012	209	AV13021	210
424018	114	431018	12	AV02031	209	AV13022	210
424019	114	431019	11	AV02033	209	AV13024	210
424020	114	431030	12	AV02034	209	AV13060	210
424021	114	431031	12	AV03010	206	AV13072	211
424022	114	440005	63	AV03011	206	AV13073	211
424023	114	440007	63	AV03020	206	AV13074	211
424024	114	440008	63	AV03030	206	AV13075	211
424025	114	440009	63	AV03031	206	AV13078	211
424026	114	440012	63	AV03032	206	AV13100	211
424027	114	440013	63	AV04010	206	AV15020	211
424028	114	481001	148	AV04011	207	C6000A	240
424029	114	481002	148	AV04020	204	C6096	240
424030	114	484001	61	AV04021	204	C8060	238
424031	114	492001	61	AV04022	205	C8061	239
424032	114	495003	61	AV04030	206	C8080	238
424033	114	495004	61	AV04031	206	C8417	239
424034	114	495005	55	AV04032	206	C8419	239
424035	114	495006	55	AV05010	203	C8431	239
424036	114	495007	55	AV05011	203	C8432	239
424037	117	495008	55	AV05015	203	C8435	239
424038	117	495009	65	AV05020	203	C9035L	237

Product	Page	Product	Page	Product	Page	Product	Page
C9036	237	G5674	232	K125BP53	262	K190BP9	271
C9036R 1	237	G5675	232	K125BP54	262	K190KC	282
C9036R 2	237	G5730	236	K125BP55	262	K190MW1	271
C9037	237	G5731	236	K125BP56	262	K190MW2	271
C9038L	237	G5732	236	K125BP57	262	K190MW3	271
C80746	238	G6276 1	236	K125DP4	262	K190MW4	271
C80766	238	G7621 15	181	K125DP5	262	K190MW5	271
C80767	238	G7621 30	181	K125HP4	262	K190MW6	271
C80787	238	G7621 50	181	K125HP5	262	K190MW7	271
C80788	238	G7625 15	181	K125KACDU	261	K190MW8	271
C80789	238	G7625 30	181	K125KC	282	K500KC	282
C807245	238	G7625 50	181	K125MP4	262	K800CBOX	277
C809510	237	G7625 75	181	K125MP5	262	K4506L85A	275
G0920	233	G7626 15	181	K125MW41	262	K4508L110A	275
G0922	233	G7626 30	181	K125MW42	262	K10050KB	281
G0923	233	G7626 50	181	K125MW43	262	K10520BLAD	252
G5010	230	G7752BI	181	K125MW44	262	K10520BLUD	252
G5011	231	G7755BI	181	K125MW51	262	K10520GRED	252
G5012	234	G7756BI	181	K125MW52	262	K10520PIND	252
G5013	234	G7900ALS	178	K125MW53	262	K10520REDD	252
G5014	234	G7903	179	K125MW54	262	K10520YELD	252
G5015	231	G7904	178	K125MW55	262	K10530BLAD	252
G5022A 6	230	G7905	179	K125PK	262	K10530BLUD	252
G5022A 8	230	G7907	179	K125PS4	262	K10530GRED	252
G5028	234	G7907Y	179	K125PS5	262	K10530PIND	252
G5029	230	G7912	180	K125PS6	262	K10530REDD	252
G5042	234	G7913	179	K130KC	282	K10530YELD	252
G5043	233	G7915 50	179	K135KC	282	K11020D	253
G5051	231	G7915 62	179	K140KC	282	K11020D2	253
G5057	231	G7915 75	179	K145KC	282	K11030D	253
G5140	235	G7916 50	179	K160KC	282	K11040D	253
G5141	236	G7916 75	179	K180BG	269	K11430D	253
G5142	235	G7918	180	K180BP1	269	K11440D	253
G5143	235	G7919	180	K180BP2	269	K11550D	254
G5144	236	G7924	178	K180BP3	269	K11670D	254
G5155 24	235	G7928	180	K180BP4	269	K11750D	255
G5155 32	235	G7932	178	K180BP5	269	K11960D	255
G5156 4	235	G7933	179	K180BP6	269	K11960XD	255
G5156 5	235	G7934	178	K180KC	282	K12020	258
G5162	234	G7943	180	K180MW1	269	K12020D	258
G5200	235	G7945	180	K180MW2	269	K12020D2	258
G5201	235	G7980	180	K180MW3	269	K12020KB	281
G5203	235	G9066	233	K180MW4	269	K12025	258
G5210	235	G9068L	233	K180MW5	269	K12025D	258
G5211	235	K120KC	282	K180PK	269	K12025D2	258
G5213	235	K124KC	282	K180RC	269	K12025KB	281
G5214	235	K125BG4	262	K190BG	271	K12025LO	277
G5215	235	K125BG5	262	K190BP0	271	K12030	258
G5217	235	K125BP41	262	K190BP1	271	K12030A1	258
G5610	232	K125BP42	262	K190BP2	271	K12030D	258
G5631	232	K125BP43	262	K190BP3	271	K12030D2	258
G5634	233	K125BP44	262	K190BP4	271	K12030KB	281
G5635	232	K125BP45	262	K190BP5	271	K12030L70BD	258
G5636	232	K125BP46	262	K190BP6	271	K12040	258
G5637	231	K125BP51	262	K190BP7	271	K12040A1	258
G5640	231	K125BP52	262	K190BP8	271	K12040D	258

Product	Page	Product	Page	Product	Page	Product	Page
K12040D2	258	K12530A5	261	K12560D	260	K17070D	272
K12040D4	258	K12530A6	261	K12560KA	261	K17090D	272
K12040KB	281	K12530D	260	K12560MK	261	K17580	272
K12040L40D	258	K12530D2	260	K12560SA	261	K17580A1	272
K12040L55A1	258	K12530KB	281	K13030A1	263	K17580D	272
K12040L55D	258	K12530L70BD	261	K13030D	263	K18060	268
K12040L63D	258	K12535D	260	K13030KB	281	K18060D	268
K12050	258	K12540	260	K13040A1	263	K18060KA	268
K12050A1	258	K12540A1	261	K13040A2	263	K18060KB	281
K12050D	258	K12540A2	261	K13040D	263	K18060MK	268
K12050D2	258	K12540A3	261	K13040D2	263	K18060XD	268
K12050KB	281	K12540A4	261	K13040KB	281	K18060XKA	268
K12050L80D	258	K12540A5	261	K13040L40D	263	K18060XMK	268
K12050SD	258	K12540A6	261	K13050	263	K19070D	270
K12060	258	K12540A7	261	K13050A1	263	K19070KA	270
K12060A2	258	K12540D	260	K13050A2	263	K19070KB	281
K12060D	258	K12540D2	260	K13050D	263	K19070MK	270
K12440BLAA1	259	K12540D4	260	K13050D2	263	K19070XD	270
K12440BLAD	259	K12540KA	261	K13050KB	281	K19070XKA	270
K12440BLUA1	259	K12540KB	281	K13060A1	263	K19070XMK	270
K12440BLUD	259	K12540L40	260	K13060D	263	K20025D	277
K12440GREA1	259	K12540L40A1	260	K13545D	264	K20038D	277
K12440GRED	259	K12540L40A5	260	K13545KB	281	K20518	278
K12440KB	281	K12540L40D	260	K13545L63D	264	K20518D	278
K12440ORAA1	259	K12540L63	260	K14040BLAD	264	K21075D	273
K12440ORAD	259	K12540L63A1	260	K14040BLUD	264	K21095D	273
K12440REDA1	259	K12540L63A5	261	K14040GOLD	264	K23060D	274
K12440REDD	259	K12540L63BD	261	K14040GRED	264	K23080D	274
K12440YELA1	259	K12540L63D	260	K14040KB	281	K30050	283
K12440YELD	259	K12540MK	261	K14040REDD	264	K45010L110A	275
K12515A1	261	K12540SA	261	K14040SILD	264	K45010L140	275
K12515A2	261	K12540XD	261	K14540A1	265	K45010L170A	275
K12515D	260	K12545D	260	K14540A2	265	K50073A	273
K12515KB	281	K12550	260	K14540A3	265	K50073ACB	273
K12520	260	K12550A1	261	K14540D	265	K50073KB	281
K12520A1	261	K12550A2	261	K14540KB	281	K50073LD	273
K12520A2	261	K12550A3	261	K14540L50A1	265	K60090D	256
K12520A3	261	K12550A4	261	K14540L50D	265	K60175D	256
K12520A4	261	K12550A5	261	K14550A1	265	K62004D	257
K12520D	260	K12550A6	261	K14550A2	265	K80040	277
K12520D2	260	K12550A7	261	K14550A3	265	K80040D	277
K12520D4	260	K12550D	260	K14550D	265	K81010	278
K12520KB	281	K12550D2	260	K14550KB	281	K81100	279
K12525	260	K12550KA	261	K14550L63A1	265	K81200	279
K12525A1	261	K12550KB	281	K14550L63D	265	K81300	280
K12525A2	261	K12550L80A1	261	K15050D	266	K210115D	273
K12525A3	261	K12550L80A5	261	K16060D	267	K230100D	274
K12525A4	261	K12550L80D	260	K16070A1	267	K230155D	274
K12525D	260	K12550MK	261	K16070A2	267	K230195D	274
K12525D2	260	K12550SA	261	K16070A3	267	K260120D	274
K12525KB	281	K12550XD	261	K16070D	267	K260190	274
K12530	260	K12560	260	K16070D2	267	K260190D	274
K12530A1	261	K12560A1	261	K16070D260	267	K470810D	276
K12530A2	261	K12560A2	261	K16070KB	281	K4506130A	275
K12530A3	261	K12560A3	261	K17063D	272	K4508135A	275
K12530A4	261	K12560A4	261	K17070	272	K4551018D	275

Product	Page	Product	Page	Product	Page	Product	Page
K4551220D	275	QCSDSKIT	246	T0297 2	240	T0969	151
K4751215D	276	QCTBD110V	245	T0814	149	T0971-10	152
K45010180A	275	QCTBD230V	245	T0815	149	T0990	60
Kasp	258	QCXP22	244	T0816	149	T1125 24	175
MA2600	196	QCXP28	244	T0817	149	T1126	155
MA2610	196	QCXP42	244	T0820	150	T1130	175
MA2627A	191	QCXP52	244	T0821	129	T1178 025	155
MA2628A	191	QCXP65	244	T0822	129	T1178 037	155
MA2630	192	QCXP78	244	T0823	129	T1178 050	155
MA2631	190	QCXP112	244	T0831	151	T1178 062	155
MA2632	192	QCXP117	244	T0832	150	T1178 075	155
MA2633	194	QCXP127	244	T0834	150	T1178 087	155
MA2634	194	QCXP152	244	T0835	150	T1178 100	155
MA2635	190	QCXPP	244	T0836A	150	T1178 125	155
MA2636	195	STAMP	282	T0837	150	T1178 150	155
MA2637	195	T0072 5	154	T0838	150	T1179LS	155
MA2638	194	T0073 6	154	T0840 20	148	T1180	155
MA2639	193	T0074 6	153	T0840 22	148	T1260	60
MA2640	193	T0075 10	153	T0865A	128	T1261	59
MA2641	194	T0079 1	154	T0865B	128	T1270	59
MA2650	193	T0079 2	154	T0865C	128	T1271	59
MA2652	193	T0079 3	154	T0865H	128	T1272	59
MA2654	190	T0080 6	152	T0865L	128	T1280	59
MA2718	196	T0080 8	152	T0865P	129	T1290	59
MA2719	196	T0080 10	152	T0865R	129	T1291	59
MA2721	198	T0080B 10	152	T0865T	129	T1350	43
MA2724	196	T0080S 6	153	T0865W	129	T1355	103
MA2727	199	T0080S 8	153	T0865X	129	T1531	136
MA2729	199	T0082 6	153	T0865Y	129	T1630 FKIT	68
MA2730	199	T0082 8	153	T0870	128	T1641	71
MA2731	198	T0082 10	153	T0875	128	T1642	71
MA2732	198	T0083 6	154	T0876	128	T1643	71
MA2733	197	T0083 8	154	T0877	127	T1881	137
MA2734	196	T0083 10	154	T0878	127	T1882	137
MA2736	197	T0106 06	153	T0880	127	T2231A	24
MA2737	197	T0106 08	153	T0905	149	T2232A	24
MA2738	196	T0107 06	153	T0931R 12	149	T2235	24
MA2740	199	T0107 08	153	T0932 12	149	T2240	24
MA2741	198	T0119	154	T0932R 1218	149	T2250	58
QCCA	247	T0120 1	154	T0933 12	149	T2250A	58
QCCADA	247	T0120 2	154	T0934 12	149	T2255	58
QCCADAKIT	246	T0120 3	154	T0934R 1232	149	T2271A	64
QCCADAM18	246	T0120 4	154	T0940 22	148	T2272A	64
QCCADAM18KIT	246	T0120 5	154	T0951	152	T2301	88
QCCAEB	247	T0120 6	154	T0953-10	152	T2302	88
QCDA	247	T0120P	154	T0954	151	T2307	88
QCDC	245	T0124P	155	T0954CBOX10	151	T2308	88
QCDCCON	246	T0208S 1	240	T0955	151	T2308A	88
QCDRILL12	247	T0208S 2	240	T0956-1	151	T2309	89
QCFM	246	T0209S 1	240	T0956-2	151	T2313A	89
QCHEX	247	T0209S 2	240	T0957-1	151	T2314	89
QCHEXKIT	246	T0211S 2	240	T0957-2	151	T2315	89
QCKOT	247	T0212S 2	240	T0958	152	T2316	89
QCPIN12	247	T0213S 1	240	T0959-10	152	T2317	89
QCQRC	247	T0213S 2	240	T0959-50	152	T2318	89
QCSDS	247	T0297 1	240	T0959-100	152	T2319	89

Product	Page	Product	Page	Product	Page	Product	Page
T2327	89	T2942-38	111	T3033 22	112	T3100 13	108
T2328	90	T2942-12400	111	T3034 10	112	T3100 13D	108
T2330	90	T2942-16400	111	T3034 13	112	T3100 015	108
T2331	90	T2942-20400	111	T3034 16	112	T3100 015TD	108
T2334	90	T2942-25400	111	T3034 20	112	T3100 025	108
T2336	90	T2942-32400	111	T3034 22	112	T3100 025TD	108
T2339	90	T2942LS	111	T3034 25	112	T3100 035	108
T2340	90	T2942P	111	T3035 03	112	T3100 035TD	108
T2340D	92	T2943-16	110	T3035 04	112	T3100 045	108
T2341	90	T2943-20	110	T3035 05	112	T3100 045D	108
T2341D	92	T2943-22	110	T3035 06	112	T3100 055	108
T2343	90	T2943-25	110	T3035 08	112	T3100 055D	108
T2345A	90	T2943-32	110	T3035 10	112	T3100 065	108
T2346	91	T2943S4	110	T3035 12	112	T3100 065D	108
T2346D	92	T2944-16	110	T3035 13	112	T3101	109
T2347	91	T2944-20	110	T3035 14	112	T3102	109
T2347D	92	T2944-22	110	T3035 16	112	T3103	109
T2348	91	T2944-25	110	T3040	112	T3104	109
T2348D	92	T2944-32	110	T3059	113	T3110 0475	107
T2349	91	T2945-16	110	T3060-CBOX	125	T3110 0585	107
T2351	91	T2945-20	110	T3060-CLIP	125	T3110 05150	107
T2354	91	T2945-22	110	T3062 01	125	T3110 05585	107
T2359	91	T2945-25	110	T3063	113	T3110 06100	107
T2360	91	T2946-16	110	T3064B	113	T3110 06150	107
T2360D	93	T2946-20	110	T3086	144	T3110 07100	107
T2361D	93	T2946-22	110	T3086S	144	T3110 07150	107
T2362D	93	T2946-25	110	T3087 3	144	T3110 08150	107
T2363D	93	T2946-32	110	T3087 4	144	T3110 10150	107
T2364	91	T2952-10	111	T3087S 3	144	T3110 12150	107
T2368D	93	T2952-12	111	T3087S 4	144	T3110 13150	107
T2369D	93	T2952-14	111	T3088	145	T3110 14150	107
T2370D	93	T2952-16	111	T3090LS	145	T3110 16150	107
T2371	103	T2952-20	111	T3100 01	108	T3110 055150	107
T2379D	93	T2952-22	111	T3100 01TD	108	T3110 065100	107
T2381	91	T2952-25	111	T3100 02	108	T3110 065150	107
T2388D	93	T2952-28	111	T3100 02TD	108	T3111	107
T2389D	93	T2952-32	111	T3100 03	108	T3112	107
T2390	87	T2952-38	111	T3100 03TD	108	T3113	108
T2391	87	T3008	109	T3100 04	108	T3113CLIP	108
T2392	87	T3010 1	109	T3100 04TD	108	T3120 0411	106
T2463	127	T3011	109	T3100 05	108	T3120 0511	106
T2601S 5090	112	T3012	109	T3100 05D	108	T3120 0516	106
T2940-2	111	T3013	109	T3100 06	108	T3120 0611	106
T2940-3	111	T3014	109	T3100 06D	108	T3120 0616	106
T2942-06	111	T3015	109	T3100 07	108	T3120 0621	106
T2942-08	111	T3031 06	112	T3100 07D	108	T3120 0711	106
T2942-10	111	T3031 08	112	T3100 08	108	T3120 0716	106
T2942-12	111	T3031 10	112	T3100 08D	108	T3120 0816	106
T2942-13	111	T3031 13	112	T3100 09	108	T3120 0821	106
T2942-14	111	T3031 16	112	T3100 09D	108	T3120 0826	106
T2942-16	111	T3031 20	112	T3100 10	108	T3120 0845	106
T2942-20	111	T3031 22	112	T3100 10D	108	T3120 1016	106
T2942-22	111	T3031 25	112	T3100 11	108	T3120 1021	106
T2942-25	111	T3031 30	112	T3100 11D	108	T3120 1026	106
T2942-28	111	T3031 32	112	T3100 12	108	T3120 1045	106
T2942-32	111	T3033 13	112	T3100 12D	108	T3120 1215	106

Product	Page	Product	Page	Product	Page	Product	Page
T3120 1221	106	T3328 06	145	T3565 100	171	T3712 5	25
T3120 1225	106	T3328 08	145	T3565 165	171	T3712 7	25
T3120 1245	106	T3328 10	145	T3565 330	171	T3712 8	25
T3120 1425	106	T3328 12	145	T3579	174	T3713 0	25
T3120 1445	106	T3328 14	145	T3581	174	T3713 5	25
T3120 1630	106	T3328 16	145	T3582	174	T3713 7	25
T3120 1645	106	T3328 20	145	T3621B 6	16	T3713 8	25
T3120 1830	106	T3328 24	145	T3621B 7	16	T3716	25
T3120 1845	106	T3328S	145	T3621B 8	16	T3721 180	13
T3120 2030	106	T3383 06	145	T3623B 5	16	T3721 200	13
T3120 2045	106	T3383 07	145	T3623B 6	16	T3735 300	138
T3120 2545	106	T3383 08	145	T3626B 8	17	T3735 350	138
T3120 05511	106	T3383 10	145	T3627B 7	16	T3735 450	138
T3120 05516	106	T3383 12	145	T3629A 400	18	T3735 600	138
T3120 06516	106	T3383 18	145	T3630 10	165	T3744	22
T3120 12100	106	T3383 101	145	T3638 07	165	T3750 145	13
T3120 16100	106	T3442 10	170	T3638 10	165	T3750 160	13
T3120 20100	106	T3442 16	170	T3641	165	T3750 180	13
T3120 25100	106	T3442 25	170	T3650 250	17	T3754	15
T3121	106	T3442M 3	170	T3651 09	17	T3755 018	102
T3131	108	T3442M 5	170	T3653 180	17	T3756 20	102
T3132	106	T3442M 8	170	T3653 250	17	T3756 25	102
T3133	107	T3447 16	170	T3653 300	17	T3756 30	102
T3145	106	T3448 16	170	T3659A 175	17	T3756 40	102
T3146	106	T3448 25	170	T3659A 240	17	T3756 50	102
T3147	106	T3448M 5	170	T3659A 300	17	T3756 60	102
T3193T	113	T3451	175	T3671A	20	T3756 80	102
T3202 016	116	T3482	171	T3673	21	T3756 100	102
T3202 020	116	T3492 11	172	T3673A	21	T3757ESD 1	102
T3202 022	116	T3494 16	171	T3676A	19	T3757ESD 2	102
T3202 025	116	T3494 24	171	T3677	20	T3757ESD 3	102
T3202 032	116	T3494 32	171	T3678	22	T3760DF 110	78
T3202 038	116	T3494 40	171	T3679	22	T3766DEF110	76
T3202 040	116	T3494 48	171	T3680A	18	T3766DEF 120	76
T3202R	116	T3494 70	171	T3681A	19	T3766DF 110	76
T3203 016	116	T3514	172	T3682A	18	T3767	83
T3203 020	116	T3517	173	T3683A	19	T3767D 120	79
T3203 022	116	T3519	173	T3684	20	T3769	83
T3203 025	116	T3520B	172	T3692A	19	T3769D 150	79
T3203 032	116	T3521B 100	173	T3695	19	T3770	83
T3203 038	116	T3521R 100	173	T3697A	19	T3770 1D120	79
T3203 040	116	T3522	172	T3698A	20	T3770D 120	79
T3212	116	T3527 413	175	T3703	84	T3771	84
T3213	116	T3527M 413	175	T3703D	80	T3771D 120	80
T3216	117	T3530 06	172	T3703DL	84	T3772	83
T3218	116	T3530 12	172	T3707DX	80	T3772 1	83
T3224	117	T3531 100	172	T3710 0	25	T3772 1D120	79
T3225	117	T3533 09	174	T3710 5	25	T3772D 120	79
T3225 2	117	T3537 09	174	T3710 7	25	T3773	80
T3230	116	T3540 09	173	T3710 8	25	T3773D 115	76
T3231	116	T3540 12	173	T3710 11	25	T3773DEF115	76
T3291	113	T3541 9	173	T3711 0	25	T3773DF 115	76
T3293	113	T3542A	174	T3711 5	25	T3773EF	80
T3319	145	T3543	173	T3711 7	25	T3773F	80
T3326	145	T3561 100	171	T3711 8	25	T3774	81
T3328 05	145	T3563 100	171	T3711 11	25	T3775	81

Product	Page	Product	Page	Product	Page	Product	Page
T3775D	77	T3867 8	15	T4229 08	142	T4343M 21H	162
T3775EF	81	T3871DF 120	78	T4229 16	142	T4343M 22	162
T3776DEF 115	78	T3880DEF 110	77	T4229 20	142	T4343M 22H	162
T3776EF 5	82	T3880DF 110	77	T4232 16	143	T4343M 24	162
T3776F	82	T3880F	82	T4232 20	143	T4343M 24H	162
T3777	83	T3883	84	T4234	143	T4343M 27	162
T3777D 150	79	T3884	84	T4310	144	T4343M 27H	162
T3778DF	78	T3885	85	T4311	138	T4343M 30	162
T3778F	82	T3886	85	T4312	144	T4343M 30H	162
T3779	80	T3887	85	T4334M 03	47	T4343M 32	162
T3779D 115	77	T3888	86	T4334M 04	47	T4343M 32H	162
T3780DEF 110	77	T3889	86	T4334M 05	47	T4344M7ST	163
T3780DF 110	77	T3890	86	T4334M 06	47	T4345/6ST	163
T3780EF	81	T3891	86	T4334M 07	47	T4346M12ST	163
T3780F	81	T3892	86	T4334M 08	47	T4347	138
T3781	82	T3893	86	T4334M 09	47	T4348	63
T3781D 115	77	T3894	87	T4334M 10	47	T4348 2	63
T3781DEF115	77	T3895	87	T4334M 11	47	T4358 12	23
T3781DF 115	77	T3906 8	15	T4334M 12	47	T4358 15	23
T3782D 115	77	T3907 8	15	T4334M 13	47	T4358 18	23
T3782DEF 115	77	T3909 5	15	T4334M 035	47	T4358 25	23
T3783	84	T3909 6	15	T4334M 045	47	T4358 36	23
T3783D	80	T3943	60	T4334M 055	47	T4360	164
T3784DF	79	T3961A 08	22	T4343M 06	162	T4365 150	164
T3786DF 120	78	T3961A 10	22	T4343M 06H	162	T4365 200	164
T3786F 4	82	T3963	17	T4343M 07	162	T4365 250	164
T3787DF 115	76	T3963 160	17	T4343M 07H	162	T4365 300	164
T3789	83	T3963 240	17	T4343M 08	162	T4366 150	165
T3796 5	84	T3964 6	13	T4343M 08H	162	T4366 200	165
T3799DEF 110	78	T3973 160	11	T4343M 09	162	T4366 250	165
T3799DF 110	78	T3973 210	11	T4343M 09H	162	T4366 300	165
T3799F	82	T3988 180	23	T4343M 10	162	T4366 375	165
T3803	15	T3988 200	23	T4343M 10H	162	T4366 450	165
T3804	15	T4032	167	T4343M/10ST	163	T4371A	23
T3805	13	T4108A 06	23	T4343M 11	162	T4406	166
T3817	27	T4108A 07	23	T4343M 11H	162	T4409	166
T3819A 408	27	T4108A 08	23	T4343M 12	162	T4411 01	165
T3819A 412	27	T4112A 08	23	T4343M 12H	162	T4411 02	165
T3819A 415	27	T4112A 10	23	T4343M/12ST	163	T4411 03	165
T3819A 508	27	T4112A 11	23	T4343M 13	162	T4411 04	165
T3819A 512	27	T4203	143	T4343M 13H	162	T4411 05	165
T3819A 515	27	T4204 08	143	T4343M 14	162	T4411 06	165
T3819A 612	27	T4208H 16	143	T4343M 14H	162	T4411 007	165
T3819A 615	27	T4211/1	145	T4343M 15	162	T4411 07	165
T3819A 620	27	T4211/2	145	T4343M 15H	162	T4411 08	165
T3820	26	T4211/3	145	T4343M 16	162	T4411 009	165
T3820AS	26	T4211/4	145	T4343M 16H	162	T4411 09	165
T3822A	26	T4219 40	143	T4343M 17	162	T4411 10	165
T3824 12	27	T4219 64	143	T4343M 17H	162	T4411 11	165
T3824 15	27	T4219A 10	143	T4343M 18	162	T4411 012	165
T3824 18	27	T4219A 15	143	T4343M 18H	162	T4411 12	165
T3852A	20	T4227A 0100	142	T4343M 19	162	T4411 13	165
T3853	20	T4227A 0200	142	T4343M 19H	162	T4411 14	165
T3866	27	T4227A 0300	142	T4343M 20	162	T4411 015	165
T3867 6	15	T4227A 0500	142	T4343M 20H	162	T4411 15	165
T3867 7	15	T4227A 1000	142	T4343M 21	162	T4411 16	165

Product	Page	Product	Page	Product	Page	Product	Page
T4411 17	165	T4550-1265T	121	T4560 PZ2L	118	T4660	160
T4411 18	165	T4554-3T	122	T4560 PZ2LD	118	T4661	161
T4411 19	165	T4554-4T	122	T4560 PZ2LD10	120	T4662	161
T4411 20	165	T4554-5T	122	T4560 PZ3	118	T4690M 10	159
T4411 22	165	T4554-6T	122	T4560 PZ3D	118	T4690M 11	159
T4411 025	165	T4555 2	121	T4560 PZ3D15	120	T4690M 12	159
T4411 035	165	T4555TIN 1T	122	T4560 PZ3LD	118	T4690M 13	159
T4411 045	165	T4556 1	121	T4560 PZ3LD10	120	T4690M 14	159
T4411 055	165	T4556-1T	121	T4560 ROB1	120	T4690M 15	159
T4411 0127	165	T4556TIN-1T	122	T4560 ROB2	120	T4690M 16	159
T4422 03	65	T4557 05	122	T4560 ROB3	120	T4690M 17	159
T4422 04	65	T4557-05T	122	T4560 SL45	119	T4690M 18	159
T4422 035	65	T4557-06T	122	T4560 SL55	119	T4690M 19	159
T4422 SET	65	T4557 07	122	T4560 SL65	119	T4690M 20	159
T4440M	164	T4557-07T	122	T4560 TX05	119	T4690M 21	159
T4443M	166	T4557 08	122	T4560 TX06	119	T4690M 22	159
T4444I	166	T4557-08T	122	T4560 TX07	119	T4690M 23	159
T4449	166	T4557 09	122	T4560 TX08	119	T4690M 24	159
T4451-2	64	T4557-09T	122	T4560 TX09	119	T4690M 27	159
T4455	64	T4557-10T	122	T4560 TX10	119	T4690M 30	159
T4456	64	T4557-15T	122	T4560 TX15	119	T4690M 32	159
T4463	159	T4557 40	122	T4560 TX20	119	T4691	159
T4501	123	T4557T 15	122	T4560 TX25	119	T4692	159
T4502	123	T4557T-15T	122	T4560 TX27	119	T4693	160
T4504	126	T4557T 20	122	T4560 TX30	119	T4694	160
T4505	61	T4557T 30	122	T4560 TX30D15	119	T4695	159
T4508	125	T4557TIN 10	122	T4560 TX40	119	T4696	160
T4509	125	T4557TIN-10T	122	T4560 TXTP10	119	T4718ESD 08	95
T4510	120	T4557TIN 15	122	T4560 TXTP15	119	T4718ESD 09	95
T4511	120	T4557TIN-15T	122	T4560 TXTP20	119	T4718ESD 10	95
T4512	121	T4557TIN 20	122	T4560 TXTP25	119	T4718ESD 15	95
T4513	121	T4557TIN 25	122	T4560 TXTP30	119	T4718ESD 20	95
T4514	127	T4557TIN 30	122	T4561	121	T4718ESD 0820	95
T4516	41	T4557TIN 40	122	T4562-2CB	125	T4718ESD 1030	95
T4517	123	T4557TIN-40T	122	T4562TIN-215	126	T4718ESD 1530	95
T4518	123	T4560 HEX25	120	T4564D	126	T4720-055	41
T4519	127	T4560 HEX30	120	T4564SDSC	126	T4720-065	41
T4520	124	T4560 HEX40	120	T4567D	126	T4720-100	41
T4521	124	T4560 HEX50	120	T4569TINC	123	T4722-0	41
T4522	124	T4560 HEX60	120	T4570	126	T4722-1	41
T4523	124	T4560 PH1	119	T4570 100	126	T4722-2	41
T4524	124	T4560 PH2	119	T4570 200	126	T4722-3	41
T4525	125	T4560 PH2D	119	T4580TIN-1T	122	T4722-1250	41
T4527	124	T4560 PH2D15	119	T4580TIN-2T	122	T4722-2250	41
T4528	124	T4560 PH2L	119	T4581	47	T4722ESD 0	94
T4536 08	26	T4560 PH2LD	119	T4582ESD	95	T4722ESD 1	94
T4536 10	26	T4560 PH2LD10	119	T4583C	123	T4722ESD 2	94
T4537AL	26	T4560 PH3	119	T4598	126	T4722ESD 13	94
T4537AR	26	T4560 PZ1	118	T4598C 08	126	T4722ESD 23	94
T4537AS	26	T4560 PZ1D	118	T4603	159	T4723-0	41
T4545 1	121	T4560 PZ1L	118	T4603 1	159	T4723-1	41
T4545 2	121	T4560 PZ1LD	118	T4645S	160	T4723-2	41
T4550-0645T	121	T4560 PZ2	118	T4654	160	T4723-3	41
T4550 0855	121	T4560 PZ2D	118	T4655	161	T4723-1250	41
T4550-0855T	121	T4560 PZ2D15	120	T4658	160	T4723-2250	41
T4550-1055T	121	T4560 PZ2D15CS	120	T4659	161	T4723ESD 0	94

Product	Page	Product	Page	Product	Page	Product	Page
T4723ESD 1	94	T4838XESD20	97	T4880XES315	96	T4987 1	46
T4723ESD 2	94	T4838XESD25	97	T4880XES410	96	T4987 2	46
T4725-030	41	T4838XESD30	97	T4880XES415	96	T4999B	47
T4725-040	41	T4840XESD32	97	T4882X 000	98	T5060 4	134
T4725-055	41	T4840XESD35	97	T4882X 00	98	T5060 5	134
T4725ESD 03	94	T4840XESD40	97	T4882X 0	98	T5060 6	134
T4725ESD 04	94	T4840XESD45	97	T4882X000ES	96	T5068	133
T4725ESD 05	94	T4840XESD50	97	T4882X0 ESD	96	T5069	133
T4725ESD 10	94	T4840XESD55	97	T4882X00ESD	96	T5070A 040	137
T4725ESD 41	94	T4844	101	T4882X 1	98	T5070A 050	137
T4726	42	T4845 09	100	T4882X1 ESD	96	T5070A 070	137
T4727	42	T4845 13	100	T4883X	99	T5070A 100	137
T4728	42	T4845 18	100	T4883XESD	97	T5073 1	134
T4729	42	T4845 26	100	T4884X	99	T5073 37	134
T4729CBOX	42	T4847	100	T4884X ESD	97	T5073 50	134
T4730ESD	95	T4847 0	100	T4896	100	T5073 62	134
T4741ESD	95	T4852P	100	T4897	100	T5073 75	134
T4741SESD	95	T4854P	100	T4925	34	T5073 99	134
T4755	63	T4856	101	T4925MOD1	34	T5075 1	137
T4760	41	T4856A	101	T4925MOD2	34	T5075 2	137
T4760CBOX	41	T4857	101	T4925PZ1	34	T5075 3	137
T4765	63	T4874X	99	T4925PZ2	34	T5075 4	137
T4797ESD	95	T4875X ESD	96	T4925S35	34	T5076	137
T4810 03	45	T4875X ESD 1	96	T4925S45	34	T5077 3	137
T4810 04	45	T4877PX	99	T4925S60	34	T5082	136
T4810 05	45	T4877X 04	99	T4928	43	T5087	136
T4810 06	45	T4877X 05	99	T4928 36M08	43	T5091 50	133
T4810 08	45	T4877X 06	99	T4928 36M10	43	T5093 50	133
T4810 10	45	T4877X 07	99	T4928 36M12	43	T5093 62	133
T4810 12	45	T4877X 08	99	T4928 36P2	43	T5093 75	133
T4811 04	45	T4877X 09	99	T4928 36P3	43	T5097	135
T4811 06	45	T4877X 10	99	T4928 362	43	T5170 1	136
T4811 08	45	T4877X 15	99	T4928 363	43	T5170 2	136
T4811 10	45	T4877XESD04	97	T4928 802	43	T5172	133
T4812 0	46	T4877XESD05	97	T4928 803	43	T5172 18	133
T4812 1	46	T4877XESD06	97	T4930	42	T5173	136
T4812 2	46	T4877XESD07	97	T4935	34	T5174	136
T4812 3	46	T4877XESD08	97	T4935PH1	34	T5180	144
T4812 4	46	T4880X/5	99	T4935PH2	34	T5198	132
T4813 0	46	T4880X 08	98	T4935S55	34	T5264	135
T4813 1	46	T4880X 12	98	T4935S65	34	T5273	135
T4813 2	46	T4880X 15	98	T4935T10	34	T5274	135
T4813 3	46	T4880X 18	98	T4935T15	34	T5298	133
T4813 4	46	T4880X 256	98	T4935T20	34	T5410	52
T4814 25	46	T4880X 257	98	T4935T25	34	T5411	54
T4814 31	46	T4880X 310	98	T4965 03	45	T5419	51
T4815 1	46	T4880X 315	98	T4965 04	45	T5420	51
T4815 2	46	T4880X 410	98	T4965 05	45	T5421	51
T4816 1	47	T4880X 415	98	T4965 06	45	T5422	51
T4816 2	47	T4880XES08	96	T4965 08	45	T5430	52
T4826D	43	T4880XES12	96	T4965 12	45	T5431	52
T4829D	43	T4880XES15	96	T4975 06	45	T5432	52
T4831 2	139	T4880XES18	96	T4975 08	45	T5433	52
T4835	139	T4880XES256	96	T4975 10	45	T5440	52
T4837	145	T4880XES257	96	T4977 1	46	T5441	51
T4838XESD15	97	T4880XES310	96	T4977 2	46	T5442 06	51

Product	Page	Product	Page	Product	Page	Product	Page
T5442 11	51	T7061	241	T30155	217	T49113-2250	37
T5450	54	T9423USB	185	T30160	217	T49117-06	38
T5460	54	T9423USBCBOX	185	T30161	218	T49117-07	38
T5510	54	T9424USB	185	T30180	219	T49117-08	38
T5520	54	T9425USB	185	T30190	219	T49117-09	38
T5530	54	T9426USB	184	T30200	219	T49117-10	38
T5600	52	T9427USB	184	T30300	218	T49117-15	38
T5720	236	T9428USB	184	T30400	218	T49117-20	38
T5721	237	T9429USB	185	T30500	218	T49117-25	38
T5912 38	167	T9608BHR	187	T30600	218	T49117-27	38
T5912 55	167	T9608R2	187	T30700	218	T49117-30	38
T5913 32	167	T9612	187	T30800	218	T49117-40	38
T5914 55	167	T9613	187	T30810	219	T49118-1	38
T5953	70	T9613USB	187	T30900	219	T49118-2	38
T5954	70	T9630USB	187	T30910	219	T49118-3	38
T5956	70	T9735USB	186	T37021 180	12	T49125-025	37
T5970	70	T9740	186	T37021 200	12	T49125-030	37
T5971	69	T9741	186	T39071-1180	11	T49125-035	37
T5980	70	T10160	220	T39071-3180	11	T49125-040	37
T5981	70	T10162	220	T39077-180	12	T49125-055	37
T5982	68	T10270	220	T40015	224	T49125-03025	37
T5983	68	T10272	221	T40024	224	T49142-0	31
T5984	68	T10280	221	T40025	224	T49142-1	31
T5985	69	T10281	221	T40026	225	T49142-2	31
T5987	69	T10282	221	T40027	225	T49142-3	31
T5988	69	T10285	221	T40028	225	T49143-0	31
T6052 51	65	T10350	221	T40029	225	T49143-1	31
T6052 52	65	T10355	222	T40035	225	T49143-2	31
T6103A	103	T10500	222	T40045	226	T49143-3	31
T6104A	103	T10700	222	T40055	226	T49143-2200	31
T6202 025	175	T19000	222	T40065	226	T49144-025	31
T6202 032	175	T19000/3	222	T40075	226	T49144-030	31
T6202 044	175	T20030	214	T40085	226	T49144-035	31
T6202 050	175	T20050	214	T40095	226	T49144-040	31
T6202 066	175	T20060	216	T40105	227	T49144-055	31
T6202 088	175	T20075	214	T40115	227	T49144-065	31
T6202 112	175	T20090	215	T48343-2	35	T49144-080	31
T6215	138	T20100	215	T48344-040	35	T49144-100	31
T6215A	138	T20220	215	T48344-055	35	T49145-1	31
T6216	138	T20310	215	T48345-2	35	T49145-2	31
T6218 06	139	T20450	215	T48349	35	T49146	31
T6218 25	139	T29030A	214	T49110-040	37	T49153	39
T6219 025	139	T29050	214	T49110-055	37	T49162D	39
T6219 125	139	T29060	216	T49110-065	37	T49163D	39
T6227	62	T29070	214	T49110-100	37	T49182D	32
T6228	62	T29090	215	T49112-0	38	T49183D	32
T6238 4	167	T29100	215	T49112-1	38	T49192D	32
T6270	167	T29300	215	T49112-2	38	T49193D	32
T6270 2	167	T29310	215	T49112-3	38	T49242-1	34
T6270 3	167	T29450	215	T49112-1250	38	T49242-2	34
T6270 4	167	T30013	216	T49112-2250	38	T49243-1	32
T6270 5	167	T30101	216	T49113-0	37	T49243-2	32
T6274 2	167	T30110	216	T49113-1	37	T49244-035	32
T6275 1	167	T30120	216	T49113-2	37	T49244-040	32
T7055 4375	241	T30125	216	T49113-3	37	T49244-055	32
T7056	241	T30140	217	T49113-1250	37	T49245	34

Product	Page	Product	Page	Product	Page	Product	Page
T49245-1	34	T524111	132	Z2240 3	24	Z4537 1	26
T49245-2	34	T524207	135	Z2240 4	24	Z4856 1	101
T49283D	34	T524306	135	Z2240 5	24	Z4856 2	101
T49283PD	34	T527010	132	Z2240 6	24	Z4856 3	101
T60100	224	T527011	132	Z3677 1	22	Z5014 2	234
T60110	224	T527111	132	Z3677 2	22	Z5031 1	235
T60115	224	T527207	134	Z3678 1	22	Z5032 0	235
T60125	224	T529207	134	Z3678 2	22	Z5041 1	234
T60150	224	T529311	132	Z3757 2	103	Z5041 2	234
T60175	224	T529510	132	Z3757 3	103	Z5043 1	233
T62000	224	T529606	134	Z3820 12	26	Z5631 2	232
T70000	222	T529750	134	Z3820 15	26	Z5631 3	232
T71000	222	Z1123	103	Z3820 18	26	Z5631 4	232
T79016	223	Z1290 1	59	Z3822A/34	26	Z5634 1	233
T79028	223	Z1290 2	59	Z4358 121	23	Z5652 7	235
T79035	223	Z1290 3	59	Z4358 151	23	Z5652 65	235
T79050	223	Z2239B	24	Z4358 181	23	Z5675 1	232
T79055	223	Z2240 1	24	Z4358 251	23		
T79070	223	Z2240 2	24	Z4358 301	23		

Terms and Conditions

DEFINITIONS

The Buyer: the person, firm or company who purchases Goods from the Company. The Company: Carl Kammerling International Ltd. Goods: All items or services which the Company is to supply to the Buyer.

CONDITIONS

All orders are accepted by the Company subject to and in accordance with the following Conditions of Sale. All orders accepted by the Company are deemed to be under these Conditions and to the absolute exclusion of all other terms and conditions (including any which the Buyer purports to apply under any purchase order, confirmation of order, specification or other document). Each order or acceptance of a quotation for Goods by the Buyer from the Company shall be deemed to be an offer by the Buyer to buy Goods subject to these Conditions.

The sub-headings of these Conditions are for ease of reference only.

PRICES

Goods are invoiced at prices ruling on date of despatch and orders are accepted only on that basis. Prices are correct at time of printing. The Company reserves the right to change prices without prior notice. Any quotation given by the Company shall not be binding until the Company dispatches an acknowledgement of order to the Buyer. Any quotation is valid for a period of 30 days only from its date, provided that the Company has not previously withdrawn it.

Promotional orders will be delivered in a single delivery to the customer's normal trading address unless the Company decides to do otherwise.

DESPATCH OF GOODS AND DELIVERY

- UK: Free on orders of £80 net value of Goods when despatched to Buyers premises in UK mainland or Isle of Wight by the Company's normal method of carriage. Northern Ireland, Channel Islands, all UK offshore islands and any non-standard delivery addresses (i.e. not Buyer's own normal delivery address), delivered free of carriage on orders of £150 net value. When a special method of delivery is requested e.g. post, Parceline a.m. service, airfreight, Datapost etc., then carriage will be charged in full regardless of order value.
- Export: For details of freight & insurance, minimum order value and carriage, ask the Buyer's usual sales contact at the Company.
- Any dates specified by the Company for delivery of Goods are intended to be an estimate only and time for delivery shall not be of the essence.
- The Company may deliver the Goods by separate instalments and each separate instalment shall be invoiced and paid for in accordance with these Conditions.
- A charge will be made for any customer specific despatch documentation required.

PACKING

Cases and cartons are free and non-returnable.

TERMS OF PAYMENT

- UK: All Goods supplied shall be paid for within 25 days from the end of the calendar month in which they are invoiced by the Company.
- Export: For details please ask the Buyer's usual sales contact at the Company.
- Time for payment shall be of the essence.
- No payment shall be deemed to have been received until the Company has received cleared funds.
- Non-compliance with the Company's terms of payment shall constitute default without reminder. In case of default the Company may charge interest at the rate of one and a half percent per month from the date upon which the payment falls due until payment is made. In the event that the Buyer shall fail to fulfil the terms of payment in respect of any invoice the Company may in its sole discretion demand payment of all outstanding balances whether due or not, cancel all outstanding orders and/or decline to make further deliveries except upon receipt of cash or satisfactory security. The Company reserves the right to claim interest under the Late Payment of Commercial Debts (Interest) Act 1998.
- The Buyer shall not be entitled to withhold or set off payment of Goods delivered by virtue of any debt claim or allegation.
- Where any prices quoted are exclusive of VAT, VAT shall be payable in addition (where applicable) at the prevailing rate.
- The Company reserves the right to operate a minimum invoice charge.
- The Company reserves the right to operate a percentage deposit charge.

PASSING OF RISK

The risk in the Goods shall pass to the Buyer when the Company delivers the Goods in accordance with the terms hereof to the Buyer or other person to whom the Company has been authorised by the Buyer to deliver the Goods whether expressly or by implication and the Company shall not be liable for the safety of the Goods thereafter and accordingly the Buyer should insure the Goods thereafter against such risks as may be commercially prudent.

RESERVATION OF PROPERTY AND RIGHTS OF DISPOSAL - UK ONLY

- Until payment by the Buyer in full of the price for the Goods and any other monies payable to the Company:
 - The Goods shall remain the sole and absolute property of the Company as legal and equitable owner.
 - The Buyer shall hold the Goods solely as a fiduciary for the Company and shall store the Goods separately from his own Goods or those of any other person and in a manner which makes them readily identifiable as the Goods of the Company and shall hold the proceeds of sale of the Goods in trust for the Company and shall keep them at all times identifiable as the Company's monies and shall not mingle them with other monies or pay them into an overdrawn bank account.
 - The Buyer shall insure the Goods against all normal commercial risk to their full replacement value with an insurance company of repute.

(iv) The Buyer's right to possession of the Goods shall terminate immediately if the Buyer has a bankruptcy order made against it, or makes an arrangement or composition with its creditors or otherwise takes the benefit of any statutory provision for the time being in force for the relief of insolvent debtors or (being a company) convenes a meeting of creditors (whether formal or informal), or enters into liquidation (whether voluntary or compulsory) except a solvent voluntary liquidation for the purpose only of reconstruction or amalgamation, or has a receiver and/or manager, administrator or administrative receiver appointed, or a resolution is passed or a petition presented for the winding up of the Buyer or for the granting of an administration order or any proceedings are commenced relating to the insolvency of the Buyer.

- The Buyer shall be deemed not to have paid the Company for Goods in the possession of the Company at any time unless the Buyer can prove that payment has been received by the Company.
- At any time prior to the payment in full of the price and other monies payable to the Company in respect of the Goods the Company or its agents may enter the premises of the Buyer and take possession of any Goods of which the Company is the owner and remove and dispose of them as the Company sees fit and the Buyer gives the Company an irrevocable licence to enter upon its premises for such purpose.
- The Company shall be entitled to recover payment for the Goods even though ownership has not passed from the Company.

MERCHANDISERS

Any merchandisers and merchandising sundries supplied by the Company remain the property of the Company and can be recalled at any time.

CARL KAMMERLING INTERNATIONAL GUARANTEE AND WARRANTY

All products are provided with a guarantee against faulty materials and/or workmanship. Carl Kammerling offer the following manufacturers guarantee to end users that purchase goods from the buyer:

BRAND:

CK Tools	12 months
CK Classic	12 months
CK Magma	12 months
Avit	12 months
Jokari	12 months
Kasp	120 months (10 years) some product exceptions apply (12 months guarantee applies on all electronic security products).
Clipacore	12 months

Any faulty products will be replaced or repaired free of charge at the discretion of the Company in accordance with the relevant guarantee if found to be faulty, unless the fault is due to wear and tear, misuse or careless handling, accident or neglect and provided:

- the products are returned immediately to the Company at the Buyer's cost;
- proof of purchase within the guarantee period is provided;
- the reason for the return is clearly stated.

This guarantee is in addition to and in no way prejudices your contractual or statutory rights.

The Company is not liable for the following: Any direct consequential loss or damage of anything whatsoever (including, without limitation, loss of profits, revenue or contracts, pure economic loss or similar loss) or for any damage to or destruction of any property, injury to or death of any person, except to the extent that such injury or death is caused by the negligence on the part of the Company or its employees; costs, damages, charges or expenses caused directly or indirectly by any delay in the delivery of the Goods (even if caused by the Company's negligence) any Goods which have been repaired or altered in any way, any Goods which have been subject to accident or damage or which have been maintained, stored or used improperly; unsuited, inappropriate and faulty application or treatment, normal wear and tear due to use.

All samples, drawings, descriptive matter, specifications and advertising issued by the Company and any descriptions or illustrations contained in the Company's catalogues or brochures are issued for guidance purposes only to give an approximate idea of the Goods described in them and do not form part of these Conditions.

CLAIMS

THE BUYER IS REQUIRED TO NOTIFY THE COMPANY BY TELEPHONE AND THEN CONFIRM IN WRITING REGARDING:

- NON DELIVERY
To the Company within 3 days of receipt of invoice which is sent to the Buyer on the day following dispatch of Goods.
- SHORTAGES
To the Company immediately.
- PILFERAGE AND DAMAGE
To the Company and its carriers within 24 hours of receipt of Goods. Carriers' sheet to be endorsed with details of open or damaged cartons.
IT IS EMPHASISED THAT DELAY BY THE BUYER MAY CAUSE THE COMPANY'S CLAIM TO BE REJECTED BY THE CARRIERS. IN THIS EVENT THE COMPANY WOULD NOT ACCEPT ANY RESPONSIBILITY FOR LOSS.
- INVOICE QUERIES
To the Company within 30 days of receipt of invoice.
- The Company shall not be liable for any non-delivery of Goods (even if caused by the Company's negligence) unless the Buyer has so notified the Company in accordance with the above provisions.
- Any liability of the Company for non-delivery of the Goods shall be limited to replacing the Goods within a reasonable time or issuing a credit note against any invoice raised for such Goods.

LIMITATION OF LIABILITY

- Subject to the provisions of paragraph (b) of this Condition it is expressly stipulated that in the event of any claim on any ground being made by the

Buyer against the Company in respect of the Goods or any matter arising from or in relation to the contract relating thereto the liability the Company shall be limited (in respect of each claim or series of connected claims) to the invoice value of the Goods and under no circumstances shall the Company be under any further liability to the Buyer whether for loss of profit or for any direct or consequential loss howsoever arising.

- Notwithstanding any provisions herein contained nothing in these Conditions shall operate or be construed as operating to exclude or restrict any liability of the Company for death or personal injury resulting from the negligence of the Company.
- Whilst every care is taken in handling Goods by the Company's employees liability is excluded for any damage to such Goods by any cause whatsoever.
- On electrical devices liability is excluded for any unforeseen circumstances brought about by power failure or spiking (not notified to the Company before installation of the equipment).

RETENTION OF DOCUMENTS

The Company will retain all documents relating to orders etc. for a maximum period of 2 years.

RETURNS

Goods supplied correctly to Buyer's order cannot be accepted for return or exchange unless by prior agreement in writing and a minimum 10% handling charge will be made.

SPECIFICATION

Due to the Company's policy of continuous improvement it reserves the right to alter specifications without prior notice. The Company also reserves the right to substitute items which have been discontinued or improved with the replacement model.

PREVIOUS CONDITIONS

If at any time one or more of the above conditions becomes in whole or in part invalid, illegal or unenforceable in any respect under any law the validity, legality and enforceability of the remaining provisions thereof and of the other Conditions herein shall not in any way be affected or impaired thereby.

STANDARD QUANTITIES

The column headed 'box qty' in the catalogues and price lists indicates the number of items contained in outer cartons. The Company reserves the right to amend the Buyer's order quantities to the nearest outer carton quantity.

FORCE MAJEURE

The Company reserves the right to defer the date of delivery or to cancel any order for Goods or to reduce the volume of Goods delivered without liability to the Buyer if it is prevented from or delayed in the carrying on of its business due to circumstances beyond its reasonable control, including (without limitation), acts of God, governmental actions, war or national emergency, acts of terrorism, protests, riot, civil commotion, fire, explosion, flood, epidemic, lock-outs, strikes or other labour disputes (whether or not relating to either party's workforce), or restraints or delays affecting carriers or inability or delay in obtaining supplies of adequate or suitable materials, provided that, if the event in question continues for a continuous period in excess of 3 months, the Buyer shall be entitled to give notice in writing to the Company to cancel the order.

GOVERNING LAW

All contracts shall be governed by English Law. In the event of any dispute whether of interpretation or otherwise or as the liability either of the Company or the Buyer arising out of the sale, use or operation or failure to operate the Goods or of any part thereof the same shall be determined by English Courts of Law to whose jurisdiction the Company and the Buyer hereby submit.

















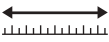













































GENERAL

- Each right or remedy of the Company under these Conditions is without prejudice to any other right or remedy of the Company, whether under these Conditions or otherwise.
- Failure or delay by the Company in enforcing any provision of these Conditions shall not be construed as a waiver of any of its rights under these Conditions.
- Any waiver by the Company of any breach of, or any default under, any provision of these Conditions by the Buyer shall not be deemed a waiver of any subsequent breach or default and in shall no way affect the other terms of these Conditions.
- It is not intended that the any term of these Conditions shall be enforceable by virtue of the Contracts (Rights of Third Parties) Act 1999 by anyone other than the Buyer and the Company.

**Carl
Kammerling**
International

United Kingdom
Carl Kammerling International Limited
Glanbury Industrial Estate,
Pwllheli,
LL53 5LH
Tel: +44 (0) 1758 701070
Fax: +44 (0) 1758 704777
E-mail: sales@cki.uk.com
www.carlkammerling.com



 Information	 Coax crimp	 Spanner size
 Box quantity	 Ferrule crimp	 Bolster width
 Size	 Insulated crimp	 Finger trowel blade width
 Weight	 Uninsulated crimp	 Rule width
 Piano wire	 Modular crimp	 Line width
 Hard wire	 Square key	 Cutting thickness
 Medium wire	 Hexagon key	 Working length
 Soft wire	 Shank diameter	 Saw blade pitch
mm^2 / AWG Wire size	 Hexagon key long arm	 Thread pitch
 Max cutting capacity	 Hexagon key short arm	 Saw blade TPI
 Serrated jaws	 Hexagon shaft	TYPE Tweezer type
 Smooth jaws	 Hexagon thickness	 Security level
 Mini bevel cut	 Blade length	 Shackle clearance
 Full flush cut	 Handle length	 Shackle diameter
 Extra full flush cut	 Slotted tip	 Lock width
BOSCH Equivalent Bosch item	 Slotted tip length	 Hasp length
 Conforms to DIN	 Slotted tip width	 Cut key type
 IEC 61340-5-1 compliant	 Modulo tip	 Blank key type
 IP rating	 Phillips tip	 Drying time
 Diameter	 Pozi tip	 Wireless range
 Mild steel	 Torx tip	WC Tungsten carbide
 High tensile steel	 Shear blade length	
 Blade direction	 Shear overall length	

Head Office:

Carl Kammerling International Ltd.
Pwllheli, LL53 5LH
United Kingdom

U.K Customer Services:

Tel: +44 (0)1758 704704
Fax: +44 (0)1758 704705

Republic of Ireland:

Tel: 1-800818 660
Fax: 1-800818 659

UK Switchboard:

Tel: +44 (0)1758 701070
Fax: +44 (0)1758 704777

Email: sales@cki.uk.com
www.carlkammerling.com

International Office:

Carl Kämmerling GmbH & Co. KG
Bendahler Str. 110,
42285 Wuppertal, Germany

Germany and Rest Of World:

Tel: +49 (0) 202.89030
Fax: +49 (0) 202.890322
Email: info@cki.de.com

France:

Tel: +33 (0)810 000044
Fax: +33 (0)810 000357
Email: info@cki.de.com

PR Support
Benelyckevägen 11
44370 Gråbo
0768 444095
peer.rott@pr-support.se
www.pr-support.se



PR SUPPORT

Carl Kammerling International Ltd. reserves the right to alter products and / or specifications without prior notice. Prices are correct at time of printing E. & O.E. All trademarks are acknowledged. All photographs are for guidance only and do not necessarily represent the products illustrated.

©2024. Published by Carl Kammerling International Ltd. No part of this publication may be produced without prior permission from Carl Kammerling International Ltd.

01.2024_UK

M5000

